

Productinformatieblad

Specificaties



Harmony - Tijdrelais - Multifunctioneel - 24-240V - Statische uitgang

RE17LMBM

EAN Code: 3606480552663

Prijs: 72,95 EUR

Hoofd

range of product	Harmony-timerrelais
digitaal uitgangstype	Vaste toestand
breedte	17,5 mm
product of component type	Modulaire tijdrelais
naam component	RE17L
tijdvertraging bereik	1...10 s 6...60 s 6...60 min 1...10 h 10...100 h 1...10 min 0.1...1 s
nominale uitgangsstroom	0,7 A

Complementair

hoogte	90 mm
diepte	72 mm
besturingstype	Keuzeschakelaar voorpaneel
Us nominale voedingsspanning	24...240 V AC 50/60 Hz
spanningsbereik	0,85...1,1 Us
voedingsfrequentie	50...60 Hz +/- 5 %
losser van input spanning	8 V
impulsduur	0,05 s typisch
isolatieweerstand	100 MOhm om 500 V DC In overeenstemming met IEC 60664-1
Uimp toegekende schokgolfspanning	5 kV gedurende 1,2/50 µs
responsvertraging	100 ms
aansluitingen - aansluitklemmen	Schroefklemmen, 1 x 0,5...1 x 3,3 mm ² (AWG 20...AWG 12) vast zonder kabeluiteinde Schroefklemmen, 2 x 0,5...2 x 2,5 mm ² (AWG 20...AWG 14) vast zonder kabeluiteinde Schroefklemmen, 1 x 0,2...1 x 2,5 mm ² (AWG 24...AWG 14) flexibel met kabeluiteinde Schroefklemmen, 2 x 0,2...2 x 1,5 mm ² (AWG 24...AWG 16) flexibel met kabeluiteinde
aanspanmoment	0,6...1 N.m In overeenstemming met IEC 60947-1
doorslagvastheid	2,5 kV 1 mA/1 minuut 50 Hz In overeenstemming met IEC 61812-1
materiaal behuizing	Polycarbonaat

De weergegeven prijs is de adviesprijs in euro excl. BTW. Deze kan onderhevig zijn aan korting. Neem contact op met uw lokale distributeur of detailhandel voor de daadwerkelijke prijs

herhalingsnauwkeurigheid	+/-0.5% In overeenstemming met IEC 61812-1
temperatuurafwijking	+/- 0,05 %/°C
spanningsverloop	+/- 0,2 %/V
instelling nauwkeurigheid tijdsvertraging	+/- 10% van totaal om 25 °C In overeenstemming met IEC 61812-1
Time delay type	Vertraging bij inschakeling - A- Vertragingrelais bij inschakeling Vertraging bij in- en uitschakelen - Ac - Vertraginginschakeling en uitschakelrelais m/ controlesignaal Vertraging bij inschakeling - Bij- Vertragingrelais bij inschakeling vermogen m/ pauze/optelling (Y1) Print gegevens - B- Eén intervalrelais met controlesignaal Print gegevens - Bw- Dubbel intervalrelais m/ besturingssignaal Vertraging bij uitschakeling - C- Uit-vertragingrelais m/ controlesignaal Symmetrisch knipperend - D- Symmetrisch knipperend relais (start pulse-off) Symmetrisch knipperend - Di- Symmetrisch knipperend relais (start puls-on) Print gegevens - H- Intervalrelais Print gegevens - Ht- Intervalrelais m/ pauze/optelling (Y1)
resettijd	350 ms bij ontkrachtiging typisch
on-load factor	100 %
maximaal energieverbruik in VA	0...3 VA om 240 V AC
maximaal energieverbruik in W	1,5 W om 240 V DC
uitschakelvermogen	0,5 A AC In overeenstemming met UL 0,7 A AC om 20 °C
werkingsnelheid in Hz	10 Hz
maximale uitgangsstroom	20 A
minimale schakelstroom	10 mA
Maximale lekstroom	5 mA
maximale schakelspanning	250 V AC
Maximale spanningsval	<4 V 3-dradig <8 V 2-dradig
elektrische levensduur	100000000 cycles
markering	CE
kruipweg	4 kV/3 In overeenstemming met IEC 60664-1
betrouwbaarheidsgegevens veiligheid	MTTFd = 353.8 jaar B10d = 320000
montagepositie	Eender welke positie in verhouding tot het normale verticale montagevlak
montagesteun	35mm DIN rail In overeenstemming met IEC 60715
functie beschikbaar	A- Vertragingrelais bij inschakeling-1 output in vaste toestand Ac - Vertraginginschakeling en uitschakelrelais m/ controlesignaal-1 output in vaste toestand Bij- Vertragingrelais bij inschakeling vermogen m/ pauze/optelling (Y1)-1 output in vaste toestand B- Eén intervalrelais met controlesignaal-1 output in vaste toestand Bw- Dubbel intervalrelais m/ besturingssignaal-1 output in vaste toestand C- Uit-vertragingrelais m/ controlesignaal-1 output in vaste toestand D- Symmetrisch knipperend relais (start pulse-off)-1 output in vaste toestand Di- Symmetrisch knipperend relais (start puls-on)-1 output in vaste toestand H- Intervalrelais-1 output in vaste toestand Ht- Intervalrelais m/ pauze/optelling (Y1)-1 output in vaste toestand
control type	Zonder testknop
gewicht product	0,068 kg
Type tijdvertraging	A, Ac, At, B, Bw, C, D, Di, H, Ht
functionaliteit	Multifunctioneel
Aantal functies	10

compatibility code	RE17
--------------------	------

Omgeving

immuñiteit voor micro-onderbrekingen	20 ms
verliesfactor	5 mA/°C
standards	2004/108/EC IEC 61000-6-2 IEC 61812-1 IEC 61000-6-4 IEC 61000-6-1 2006/95/EC IEC 61000-6-3
product certifications	GL cULus CSA
ambient air temperature for storage	-30...60 °C
omgevingstemperatuur voor werking	-20...60 °C
IP beschermingsgraad	IP20 In overeenstemming met IEC 60529 (aansluitblok) IP40 In overeenstemming met IEC 60529 (behuizing) IP50 In overeenstemming met IEC 60529 (voorpaneel)
trilling bestendigheid	20 m/s ² (f= 10...150 Hz) In overeenstemming met IEC 60068-2-6
schokbestendigheid	15 gn voor 11 ms In overeenstemming met IEC 60068-2-27
relatieve vochtigheid	93 % zonder condensatie In overeenstemming met IEC 60068-2-30
elektromagnetische compatibiliteit	Elektrostatische ontlading immuñiteitstest: , 6 kV (in contact), niveau 3, conform aan IEC 61000-4-2 Elektrostatische ontlading immuñiteitstest: , 8 kV (in lucht), niveau 3, conform aan IEC 61000-4-2 Gevoelig aan elektromagnetische velden: , 10 V/m (80 MHz tot 1 GHz), niveau 3, conform aan IEC 61000-4-3 Elektrische snelle transiënte/burst immuñiteitstest: , 1 kV (capacitieve verbindingsclip), niveau 3, conform aan IEC 61000-4-4 Elektrische snelle transiënte/burst immuñiteitstest: , 2 kV (rechtstreeks), niveau 3, conform aan IEC 61000-4-4 1,2/50 µs schokgolven immuñiteitstest: , 1 kV (differentieelmodus), niveau 3, conform aan IEC 61000-4-5 1,2/50 µs schokgolven immuñiteitstest: , 2 kV (gewone modus), niveau 3, conform aan IEC 61000-4-5 Geleidende RF verstoringen: , 10 V (0,15...80 MHz), niveau 3, conform aan IEC 61000-4-6 Spanningsval en onderbrekingen immuñiteitstest: , 0 % (1 cyclus), conform aan IEC 61000-4-11 Spanningsval en onderbrekingen immuñiteitstest: , 70 % (25/30 cycli), conform aan IEC 61000-4-11 Geleide en uitgestraalde emissies: , klasse B, conform aan EN 55022

Verpakkingseenheid

Eenheidstype van verpakking 1	PCE
Aantal eenheden in verpakking 1	1
verpakking 1 hoogte	2,8 cm
verpakking 1 breedte	7,8 cm
verpakking 1 lengte	9,4 cm
verpakking_1_gewicht	72,0 g
Eenheidstype van verpakking 2	S02
Aantal eenheden in verpakking 2	40
verpakking 2 hoogte	15,0 cm

verpakking 2 breedte	30,0 cm
verpakking 2 lengte	40,0 cm
verpakking 2 gewicht	3,222 kg

contractuele waarborg

Garantie (in maanden)	18
-----------------------	----

Schneider Electric wil tegen 2050 de Net Zero-status hebben bereikt via partnerschappen in de toeleveringsketen, materialen met een lagere impact en circulariteit via onze doorlopende campagne "Use Better, Use Longer, Use Again" om de levensduur van producten en de recycleerbaarheid te verlengen.

[Uitleg van Environmental Data >](#)

[Hoe evalueren we de duurzaamheid van producten? >](#)

Milieuoetafdruk

Totale levenscyclus ecologische voetafdruk	43 kg CO2 eq.
Koolstofvoetafdruk van de fabricagefase [A1–A3]	2 kg CO2 eq.
Koolstofvoetafdruk van de distributiefase [A4]	0.1 kg CO2 eq.
Koolstofvoetafdruk van de installatiefase [A5]	0 kg CO2 eq.
Koolstofvoetafdruk van de gebruiksfase [B2, B3, B4, B6]	41 kg CO2 eq.
Koolstofvoetafdruk van de einde-levensfase [C1–C4]	0.2 kg CO2 eq.
Milieu Profiel	Milieuprofiel van het product

Use Better

Materialen en verpakking

Pakket met gerecycleerd karton	Ja
Verpakkingen zonder kunststof	Ja
SCIP-nummer	7bdc2711-0ad2-427c-8ece-532c5e9f09d7
RoHS-richtlijn van de EU	Conform door vrijstelling
REACH-verordening	Referentie bevat zorgwekkende stoffen (SVHC) boven drempelwaarde

Use Longer

Levensduurverlenging

Reparatie	Nee
-----------	-----

Use Again

Herverpakken en herfabriceren

Percentage mogelijke recycleerbaarheid	13
Circulair Profiel	Informatie over einde levensduur
Terugname	Ja

Dimensions Drawings

Width 17.5 mm

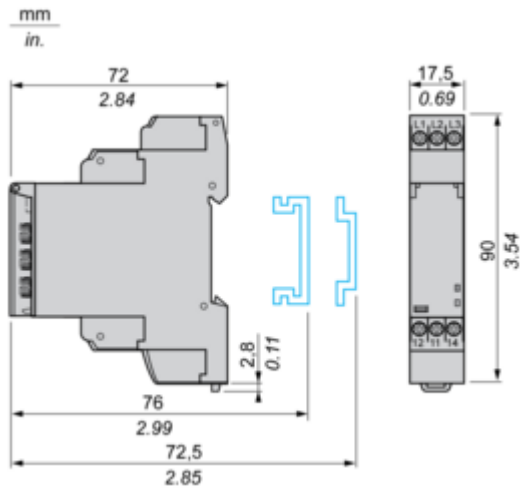

Connections and Schema

Internal Wiring Diagram

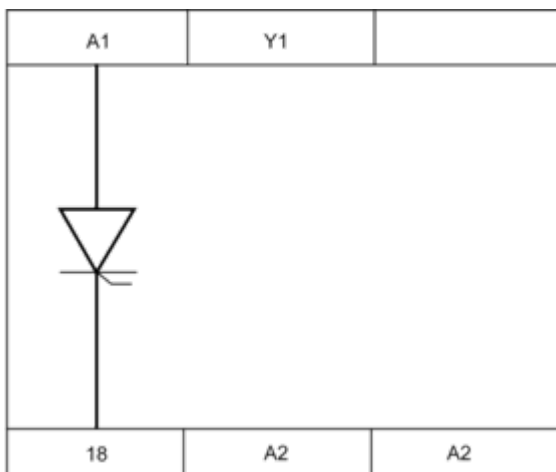

Wiring Diagram

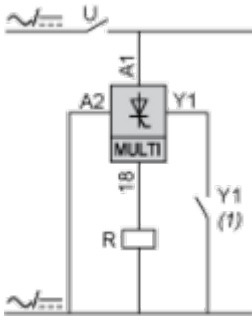

(1) Contact Y1:

- Control for functions B, C, Ac, Bw.
- Partial stop for functions At, Ht.
- Function D if Di selected.
- Not used for functions A and H.

Technical Description

Function A : Power on Delay Relay

Description

The timing period T begins on energisation. After timing, the output(s) R close(s). The second output can be either timed or instantaneous.

Function: 1 Output

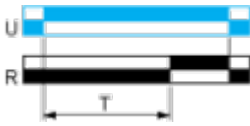

Function: 2 Outputs

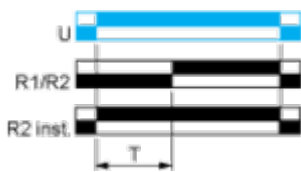

2 timed outputs (R1/R2) or 1 timed output (R1) and 1 instantaneous output (R2 inst.)

Function Ac: On-Delay & Off-Delay with Control Signal

Description

After energisation of power supply and energization of Y1 causes the timing period T to start.
At the end of this timing period, the output(s) R close(s).
When deenergization of Y1, the timing T starts.
At the end of this timing period T, the output(s) R revert(s) to its/their initial position.
The second output (R2) can be either timed (when set to "TIMED") or instantaneous (when set to "INST").

Function: 1 Output



Function: 2 Outputs

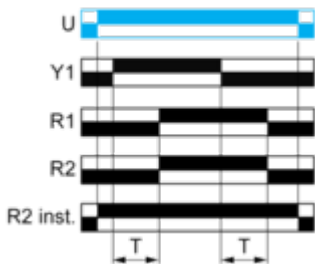

Function At : Power on Delay Relay (Summation) with Control Signal

Description

After power-up, the first opening of control contact C starts the timing. Timing can be interrupted each time control contact C closes. When the cumulative total of time periods elapsed reaches the pre-set value T, the output relay closes.

Function: 1 Output

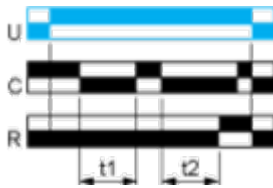

$T = t1 + t2 + \dots$

Function B : Interval Relay with Control Signal

Description

After power-up, pulsing or maintaining control contact C starts the timing T. The output R closes for the duration of the timing period T then reverts to its initial state.

Function: 1 Output

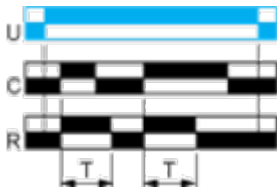

Function Bw : Double Interval Relay with Control Signal

Description

On closing and opening of control contact C, the output R closes for the duration of the timing period T.

Function: 1 Output

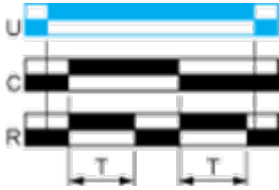

Function C : Off-Delay Relay with Control Signal

Description

After power-up and closing of the control contact C, the output R closes. When control contact C re-opens, timing T starts. At the end of the timing period, the output(s) R revert(s) to its/their initial state. The second output can be either timed or instantaneous.

Function: 1 Output

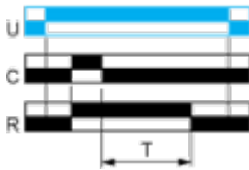

Function: 2 Outputs

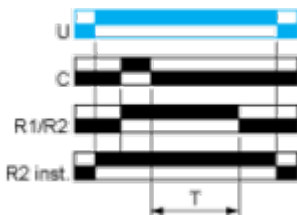

2 timed outputs (R1/R2) or 1 timed output (R1) and 1 instantaneous output (R2 inst.)

Function D: Symmetrical Flashing Relay (Starting Pulse Off)

Description

On energisation of power supply, output(s) R starts at its/their initial state for timing duration T then change(s) to output(s) R close(s) for the same timing duration T. This cycle is repeated indefinitely until power supply removal. Specially for RE17*, RE22R2AMU, RE22R2MMW, RE22R2MMU, RE22R2MJU, this D function can only be initiated by energizing Y1 permanently. The second output (R2) can be either timed (when set to "TIMED") or instantaneous (when set to "INST").

Function: 1 Output

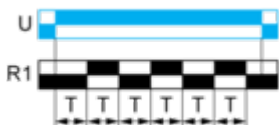

Function: 2 Outputs

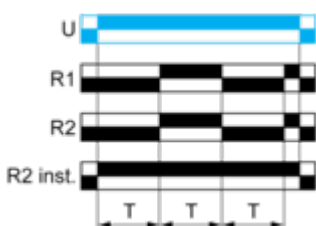

Function: 1 Output with Retrigger / Restart Control

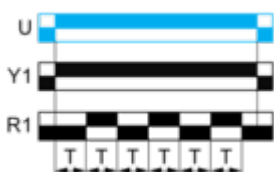

Function: 2 Output with Retrigger / Restart Control

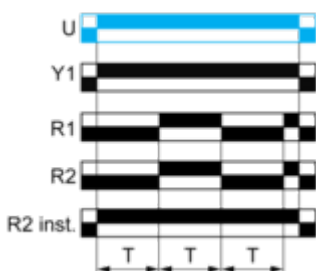

Function Di : Symmetrical Flasher Relay (Starting Pulse On)

Description

Repetitive cycle with two timing periods T of equal duration, with output(s) R changing state at the end of each timing period T.

The second output can be either timed or instantaneous.

Function: 1 Output



Function: 2 Outputs

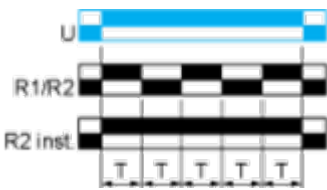

2 timed outputs (R1/R2) or 1 timed output (R1) and 1 instantaneous output (R2 inst.)

Function H : Interval Relay

Description

On energisation of the relay, timing period T starts and the output(s) R close(s). At the end of the timing period T, the output(s) R revert(s) to its/their initial state. The second output can be either timed or instantaneous.

Function: 1 Output



Function: 2 Outputs

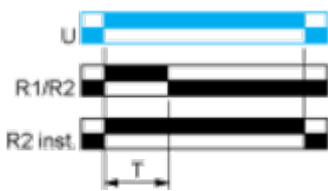

2 timed outputs (R1/R2) or 1 timed output (R1) and 1 instantaneous output (R2 inst.)

Function Ht: Interval Relay & With Pause / Summation Control

Description

On energisation of power supply, output(s) R close(s) and timing period T starts.

The timing can be interrupted / paused each time X1 energizes.

When the cumulative total of time periods elapsed reaches the pre-set value T, the output(s) R revert(s) to its/their initial state Reenergization of X1 will also cause output(s) R close(s) if the time has elapsed and restart the same operation as described at the beginning.

Except for RE17*, RE22R2MMW, RENF22R2MMW, RE22R2MMU and RE22R2MJU, timing can be interrupted / paused each time Y1 energizes.

The second output (R2) can be either timed (when set to "TIMED" or instantaneous (when set to "INST").

Function: 1 Output

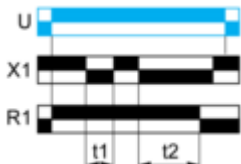

$T = t1 + t2 + \dots$

Function: 2 Outputs

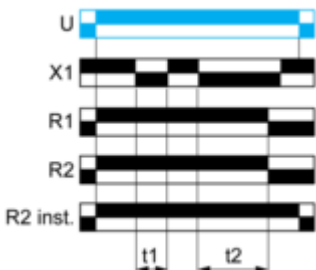

$T = t1 + t2 + \dots$

Function: 1 Output with Retrigger / Restart Control

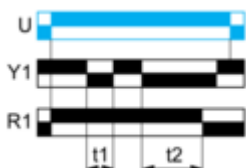



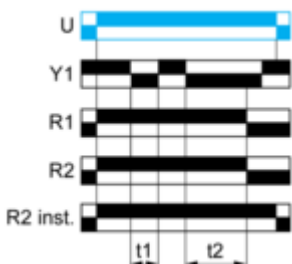

$T = t1 + t2 + \dots$

Function: 2 Outputs with Retrigger / Restart Control



$T = t1 + t2 + \dots$

Legend

	Relay de-energised
	Relay energised
	Output open
	Output closed

C	Control contact
G	Gate
R	Relay or solid state output
R1/R2	2 timed outputs
R2 inst.	The second output is instantaneous if the right position is selected
T	Timing period
Ta -	Adjustable On-delay
Tr -	Adjustable Off-delay
U	Supply

Technical Illustration

Dimensions

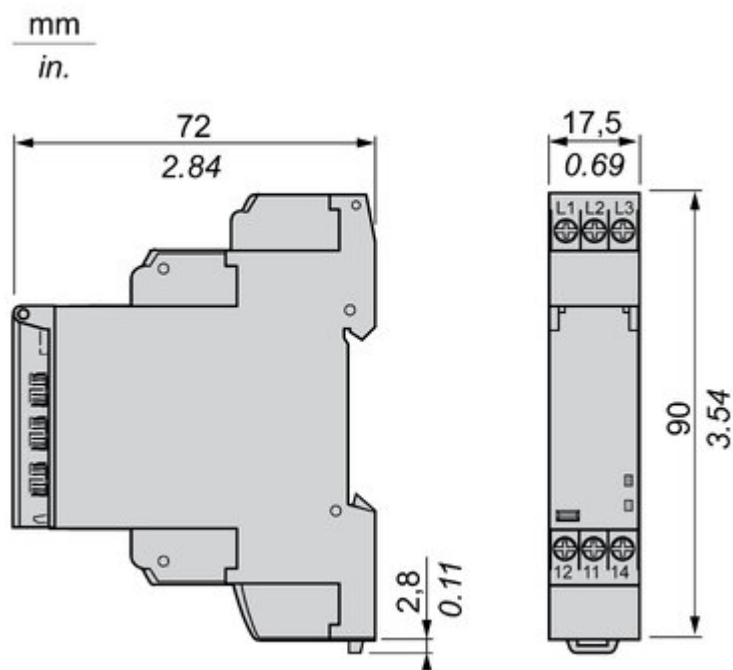

Offer Marketing Illustration

Product benefits / Features

Technical Benefits

Harmony Timer Relay

Flexible choice of screw or spring connection terminals for wiring.

One product reference covering 28 timing functions, 2 outputs, and a wide range of supply voltage 24...240 V AC/DC.

Dust and unintended human intervention avoided thanks to the IP50 lead-sealable settings protection cover.



A Dial-Pointer LED indicator that enhances ease of operation in difficult environments such as dusty or low-light conditions

Different mounting style to meet your preference:
DIN rail mount with product width; 17.5 mm/0.69 in.
22.5 mm/0.88 in.
Plug in mounting with socket

Offer Marketing Illustration

Product benefits / Features



Features

Harmony Timer Relay

- 

"Diagnostic button" to check downstream circuit immediately, shorten the commission and troubleshooting time
- 

Compatible with a wide range of applications including machines, buildings, water segments, and HVAC.
- 

Wide range of time delay for adjustment: from 0.01 s to 999 hrs.
- 

Compliant with IEC 60255-1 standard, and a wide array of product certifications such as UL, CE, CSA, EAC.
- 

Unprecedented accuracy, predictive maintenance, and superior security.

Image of product / Alternate images

Alternative





Image of product in real life situation

