

## Drive for Wilo-Helix2.0-VE / Wilo-Medana CH3-LE



**en** Installation and operating instructions





## Table of contents

<b>1</b>	<b>General information</b> .....	<b>5</b>
1.1	About these instructions .....	5
1.2	Copyright .....	5
1.3	Subject to change .....	5
<b>2</b>	<b>Safety</b> .....	<b>5</b>
2.1	Identification of safety instructions.....	5
2.2	Personnel qualifications.....	6
2.3	Electrical work .....	7
2.4	Transport.....	7
2.5	Installation /Dismantling.....	8
2.6	Maintenance tasks.....	8
2.7	Operator responsibilities.....	8
<b>3</b>	<b>Application/use</b> .....	<b>9</b>
3.1	Intended use .....	9
3.2	Improper use .....	10
<b>4</b>	<b>Description of the drive</b> .....	<b>10</b>
4.1	Product description .....	10
4.2	Technical data .....	12
4.3	Scope of delivery.....	13
4.4	Accessories .....	13
<b>5</b>	<b>Installation</b> .....	<b>13</b>
5.1	Personnel qualifications.....	13
5.2	Operator responsibilities.....	13
5.3	Safety.....	14
5.4	Permitted installation positions and change of the arrangement of components before the installation.....	15
5.5	Permitted installation positions with horizontal motor shaft.....	15
5.6	Preparing the installation.....	16
5.7	Double pump installation.....	17
5.8	Installation and position of additional sensors to be connected.....	18
<b>6</b>	<b>Electrical connection</b> .....	<b>19</b>
6.1	Mains connection.....	24
6.2	SSM and SBM connection .....	26
6.3	Connection of digital, analogue and bus inputs.....	26
6.4	Differential pressure sensor connection .....	27
6.5	Wilo Net connection.....	27
6.6	Turn of the display .....	27
<b>7</b>	<b>Installation of CIF module</b> .....	<b>28</b>
<b>8</b>	<b>Commissioning</b> .....	<b>29</b>
8.1	Procedure after switching on the power supply during initial commissioning.....	29
8.2	Description of the operating elements.....	30
8.3	Pump operation.....	31
<b>9</b>	<b>Control settings</b> .....	<b>37</b>
9.1	Control functions.....	38
9.2	Selecting a control mode.....	40
9.3	Switch off the pump.....	48
9.4	Configuration storage/data storage.....	49
<b>10</b>	<b>Monitoring functions</b> .....	<b>49</b>
10.1	Min. pressure detection.....	50
10.2	Max. pressure detection.....	50
10.3	Lack of water detection .....	51
<b>11</b>	<b>Double pump operation</b> .....	<b>53</b>
11.1	Function.....	53
11.2	Settings menu.....	55
11.3	Display in double pump operation.....	57
<b>12</b>	<b>Communication interfaces: Setting and function</b> .....	<b>58</b>
12.1	Menu overview of "External interfaces" .....	58
12.2	SSM application and function.....	58
12.3	SSM relay forced control .....	60
12.4	SBM application and function .....	60
12.5	SBM relay forced control .....	61
12.6	Application and function of the digital control input DI 1 .....	62
12.7	Application and function of the analogue inputs AI1 and AI2 .....	65
12.8	Application and function of the Wilo Net interface.....	71
12.9	Application and function of CIF module .....	72
<b>13</b>	<b>Display settings</b> .....	<b>72</b>
13.1	Brightness.....	73
13.2	Language .....	73
13.3	Units.....	73
13.4	Key lock ON.....	74
<b>14</b>	<b>Additional settings</b> .....	<b>74</b>
14.1	Pump kick.....	75
14.2	Setting pump ramp times .....	75
14.3	PWM frequency reduction .....	76
14.4	Fluid correction.....	76
<b>15</b>	<b>Diagnostics and measured values</b> .....	<b>76</b>
15.1	Diagnostics help .....	77
15.2	Measured values.....	80
<b>16</b>	<b>Reset</b> .....	<b>81</b>
16.1	Factory setting .....	81
<b>17</b>	<b>Faults, causes and remedies</b> .....	<b>82</b>
17.1	Mechanical faults without error messages.....	83
17.2	Error messages .....	83
17.3	Warning messages .....	85
<b>18</b>	<b>Maintenance</b> .....	<b>88</b>
18.1	Replacing the electronic module .....	90
18.2	Replacing the motor/drive .....	91
18.3	Module fan replacement .....	91
<b>19</b>	<b>Spare parts</b> .....	<b>93</b>
<b>20</b>	<b>Disposal</b> .....	<b>94</b>

## 1 General information

### 1.1 About these instructions

These instructions form part of the product. Compliance with the instructions is essential for correct handling and use:

- Read the instructions carefully before all activities.
- Keep the instructions in an accessible place at all times.
- Observe all product specifications.
- Observe the markings on the product.

The language of the original operating instructions is German. All other languages of these instructions are translations of the original operating instructions.

### 1.2 Copyright

WILO SE © 2023

The reproduction, distribution and utilization of this document as well as the communication of its contents to others without express authorization is prohibited. Offenders will be held liable for the payment of damages. All rights reserved.

### 1.3 Subject to change

Wilo shall reserve the right to change the listed data without notice and shall not be liable for technical inaccuracies and/or omissions. The illustrations used may differ from the original and are intended as an example representation of the device.

## 2 Safety

This chapter contains basic information for the individual phases of the life cycle. Failure to observe this information carries the following risks:

- Injury to persons from electrical, mechanical and bacteriological factors as well as electromagnetic fields
- Environmental damage from discharge of hazardous substances
- Property damage
- Failure of important functions of the product

Failure to observe the information contained herein will result in the loss of claims for damages.

**The instructions and safety instructions in the other chapters must also be observed!**

### 2.1 Identification of safety instructions

#### Symbols:



#### WARNING

General safety symbol



#### WARNING

Danger caused by electric voltage



#### NOTICE

Notices

#### Signal words

**DANGER**

Imminent danger.

Failure to observe the safety instructions will result in serious injuries or death!

**WARNING**

Failure to follow instructions can lead to (serious) injury!

**CAUTION**

Failure to follow instructions can lead to property damage, total loss is possible. "Caution" is used when there is a risk to the product if the user does not observe procedures.

**NOTICE**

Note containing useful information for the user about the product. It assists the user in the case of an issue;

Follow all information that appears on the product and ensure that it remains permanently legible:

- Warnings
- Rating plate
- direction of rotation arrow
- Identification of connections

## 2.2 Personnel qualifications

Personnel must:

- Be instructed about locally applicable regulations governing accident prevention.
- Have read and understood the installation and operating instructions.

Personnel must have the following qualifications:

- Electrical work: A qualified electrician must carry out the electrical work.
- Installation/dismantling: The technician must be trained in the use of the necessary tools and fixation materials.
- The product must be operated by persons who have been instructed on how the complete system functions.
- Maintenance work: The technician must be familiar with the use of operating fluids and their disposal.

### Definition of "qualified electrician"

A qualified electrician is a person with appropriate technical education, knowledge and experience who can identify and prevent electrical hazards. The operator must confirm and ensure the field of authority, the competence and the monitoring of the person-

nel. If the personnel do not possess the necessary knowledge, they must be trained and instructed. If required, this can be carried out by the product manufacturer at the operator's request.

## 2.3 Electrical work

- Have electrical work carried out by a qualified electrician.
- When connecting to the local power supply system, comply with the nationally applicable guidelines, standards and regulations as well as specifications issued by the local energy supply companies.
- Before commencing work, disconnect the product from the mains and secure it against being switched on again.
- Give personnel training on how to establish the electrical connection and the methods for switching off the product.
- Protect the electrical connection with a residual-current device (RCD).
- Observe the technical information in these installation and operating instructions as well as on the rating plate.
- Earth the product.
- Comply with the manufacturer's specifications when connecting the product to electrical switching systems.
- Have a defective connection cable replaced immediately by a qualified electrician.
- Never remove operating elements.



### WARNING

#### DANGER

When dismantled, the permanent magnet rotor inside the pump can pose mortal danger for people with medical implants (e.g. pacemakers). Follow the general behavioural guidelines that apply to handling electrical devices!

**Do not open the motor!**

**Dismantling and installation of the rotor may only be carried out by Wilo customer service! If you have been fitted with a pacemaker, you must not carry out this kind of work!**



### NOTICE

The magnets inside the motor do not pose a danger **provided the motor is completely assembled**. Persons with pacemakers can approach the pump without restrictions.

## 2.4 Transport

- Wear protective equipment:
  - Safety gloves for protection against cuts
  - Safety shoes
  - Sealed safety glasses
  - Safety helmet (when using lifting equipment)
- Only use legally specified and approved lifting slings.
- Select lifting gear based on the available conditions (weather, attachment point, load, etc.).

- Always attach the lifting gear to the designated attachment points (lifting eyes).
- Position the lifting equipment in a way that ensures stability during use.
- When using lifting equipment, a second person must be present to coordinate the procedure if required (e.g. if the operator's field of vision is blocked).
- Persons must not stand underneath suspended loads. Do not move loads over workplaces where people are present.

## 2.5 Installation /Dismantling

- Wear protective equipment:
  - Safety shoes
  - Safety gloves for protection against cuts
  - Safety helmet (when using lifting equipment)
- Locally applicable laws and regulations on work safety and accident prevention must be complied with.
- Disconnect the device from the mains and secure it against being switched on again without authorisation.
- All rotating parts must be at a standstill.
- Close the gate valve in the inlet and in the pressure pipe.
- Provide adequate aeration in enclosed spaces.
- Make sure that there is no risk of explosion when carrying out any type of welding work or work with electrical devices.

## 2.6 Maintenance tasks

- Wear protective equipment:
  - Sealed safety glasses
  - Safety shoes
  - Safety gloves for protection against cuts
- Locally applicable laws and regulations on work safety and accident prevention must be complied with.
- The procedure described in the installation and operating instructions for shutting down the product/unit must be strictly observed.
- Only original parts from the manufacturer may be used for maintenance and repairs. The use of any non-original parts releases the manufacturer from any liability.
- Disconnect the device from the mains and secure it against being switched on again without authorisation.
- All rotating parts must be at a standstill.
- Close the gate valve in the inlet and in the pressure pipe.
- Store tools at the designated locations.
- After completing work, reattach all safety and monitoring devices and check that they function properly.

## 2.7 Operator responsibilities

- Provide installation and operating instructions in a language which the personnel can understand.



- Make sure that personnel are suitably trained for the specified work.
- Verify the area of responsibility and individual responsibilities of personnel.
- Provide the necessary protective equipment and make sure that personnel wear it.
- Ensure that safety and information signs mounted on the device are always legible.
- Train personnel with regard to the operating principles of the system.
- Eliminate risks from electrical current.
- Equip hazardous components (extremely cold, extremely hot, rotating, etc.) with a guard to be provided by the customer.
- Keep highly flammable materials at a safe distance from the product.
- Ensure compliance with the regulations for accident prevention.
- Ensure compliance with local directives or general directives [e.g. IEC, VDE, etc.] and instructions from local energy supply companies.

Follow all information that appears on the product and ensure that it remains permanently legible:

- Warnings
- Rating plate
- direction of rotation arrow
- Identification of connections

This device can be used by children from 8 years of age as well as people with reduced physical, sensory or mental capacities or lack of experience and knowledge if they are supervised or instructed on the safe use of the device and they understand the dangers that can occur. Children are not allowed to play with the device. Cleaning and maintenance by the user must not be carried out by children without supervision.

### 3 Application/use

#### 3.1 Intended use

The drive is used in vertical and horizontal multistage pump series. They can be used for:

- Water distribution and boosting
- Industrial circulation systems
- Process water
- Closed cooling circuits
- Heating
- Washing systems
- Irrigation

#### **Installation within a building:**

Drive is to be installed in dry, well-ventilated, frost-proof rooms.

### Installation outside a building (outdoor installation)

- Observe permissible environmental conditions and protection class.
- Install the drive in a housing as weather protection. Observe permissible ambient temperatures (see "Technical data" table).
- Protect the drive against the effects of weather, for example, direct sunlight, rain and snow.
- Protect the drive so that the condensate drain openings remain free of dirt.
- Take suitable measures to prevent the formation of condensation water.

Intended use includes compliance with these instructions as well as the information and markings on the drive.

Any use beyond the intended use is considered misuse and will void any warranty claims.

## 3.2 Improper use

The operational reliability of the supplied product is only guaranteed for intended use in accordance with chapter "Intended use" of the installation and operating instructions. The limit values must not fall below or exceed those values specified in the catalogue/data sheet.



### CAUTION

#### Misuse of the drive can lead to dangerous situations and damage!

Drive without an Ex rating are not suitable for use in potentially explosive atmospheres.

- . Highly flammable materials/fluids should always be kept at a safe distance from the device.
- . Never allow unauthorised work.
- . Never carry out unauthorised conversions.
- . Use authorised accessories and genuine spare parts only.

## 4 Description of the drive

### 4.1 Product description

The drive is composed of frequency inverter and "Electronic Commutated Motor" (ECM) to be integrated on vertical and horizontal multistage pump.

Fig.1 show an exploded view drawing of the drive with the main components. The drive structure is explained in detail below.

Arrangement of the main components according to Fig.1, Fig.2 and Fig.3 of the table "Arrangement of the main components":

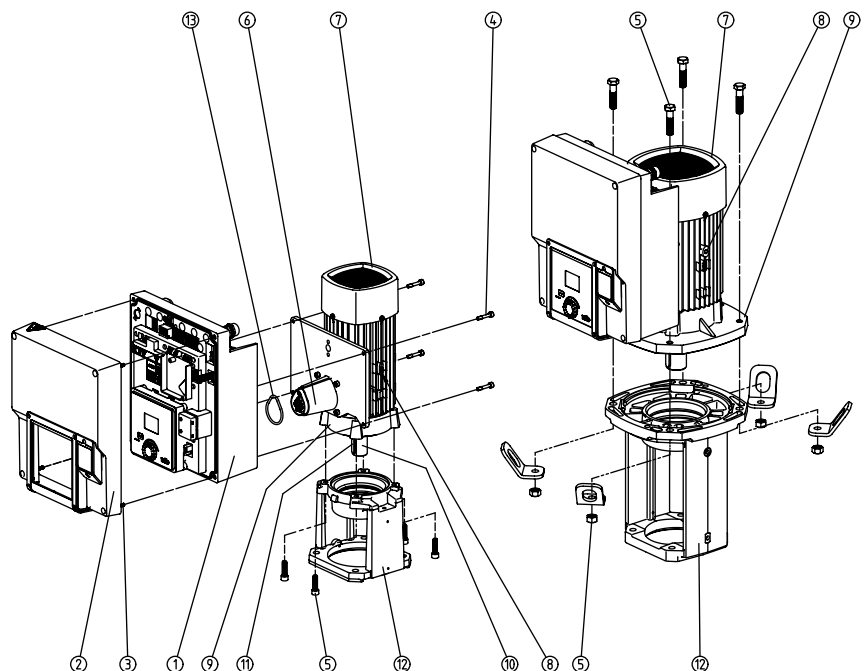

Fig. 1: Main components

No.	Component
1	Electronic module lower part
2	Electronic module upper part
3	Fastening screws of the electronic module upper part, 4x
4	Fastening screws of the electronic module lower part, 4x
5	Fastening screw of the motor, main fastening, 4x
6	Motor adapter for electronic module
7	Motor housing
8	Fixation points for transport lugs on motor housing, 2x
9	Motor flange
10	Motor shaft
11	Key shaft
12	Lantern
13	O-ring

Table 1: Arrangement of the main components

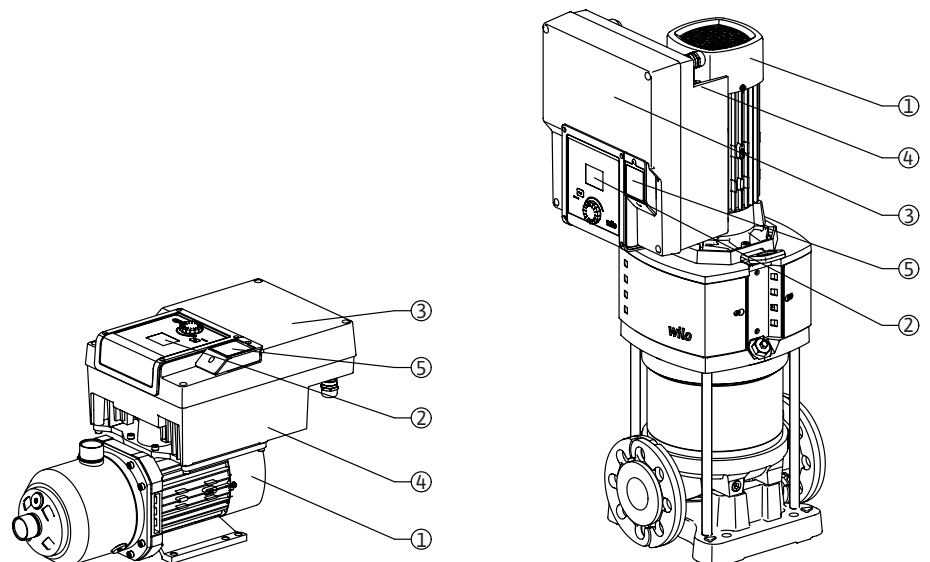

Fig. 2: Drive overview

Item	Name	Explanation
1	Motor	Drive unit. Forms the drive together with the electronic module.
2	Graphic display	Provides information about settings and pump status. Self-explanatory user interface for setting the pump.
3	Electronic module	Electronic unit with graphic display
4	Electrical fan	Cools down the electronic module.
5	Wilo-Connectivity Interface	Optional interface

Table 2: Description of the pump

1. The motor with mounted electronic module can be rotated relative to the lantern. Observe the instructions in the chapter "Permitted installation positions and change of the arrangement of components before the installation".
2. The display can be rotated in 90° steps as required. (see chapter on "Electrical connection").
3. Electronic module
4. An unobstructed and free air flow must be ensured around the electric fan. (See chapter on "Installation")

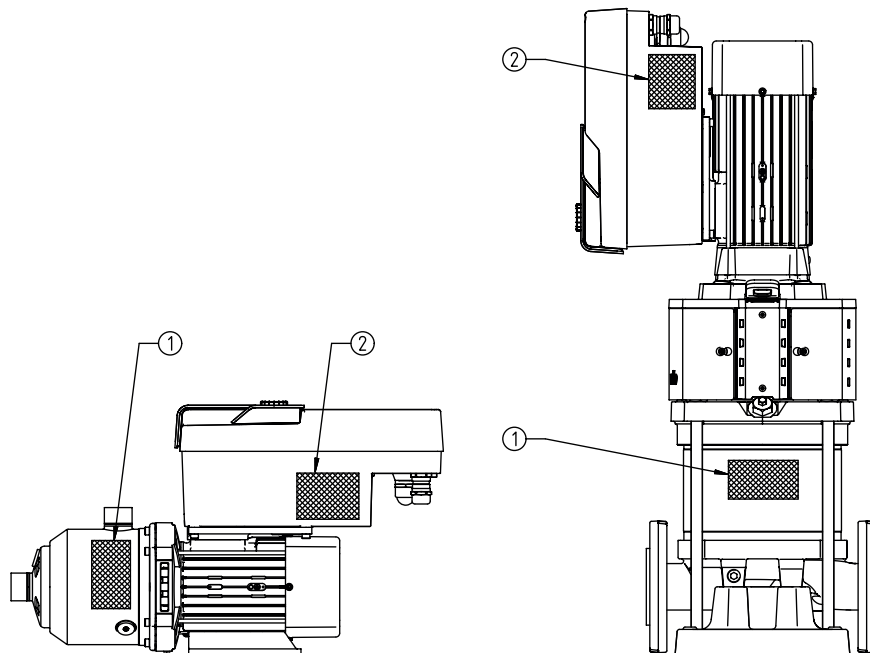

Fig. 3: Rating plates

1	Pump rating plate
2	Drive rating plate

Table 3: Rating plates

- There is a serial number on the pump rating plate. It must be specified e.g. for ordering spare parts.
- The drive rating plate is located on the side of the electronic module. The electrical connection must be designed according to the specifications on the drive rating plate.

## 4.2 Technical data

Property	Value	Notice
<b>Electrical connection</b>		
Voltage range	1~220 V ... 1~240 V ( $\pm 10\%$ ), 50/60 Hz 3~380 V ... 3~440 V ( $\pm 10\%$ ), 50/60 Hz	Supported mains types: TN, TT, IT <sup>1)</sup>
Performance range	1~ 0.55 kW ... 2.2 kW 3~ 0.55 kW ... 7.5 kW	depending on drive type
Speed range	1000 rpm 3600 rpm	depending on drive type
<b>Ambient conditions<sup>2)</sup></b>		
Protection class	IP55	EN 60529
Ambient temperature during operation min./max.	0°C... +50°C	Lower or higher ambient temperatures on request
Temperature during storage min./max.	-30°C... +70°C	> +60°C limited to a duration of 8 weeks
Temperature during transport min./max.	-30°C... +70°C	> +60°C limited to a duration of 8 weeks
relative humidity	<95 %, non-condensing	
Installation height max.	2000 m above sea level	
Insulation class	F	
Pollution degree	2	DIN EN 61800-5-1
Motor protection	Integrated	
Overvoltage protection	Integrated	
Overvoltage category	OVCIII + SPD/MOV <sup>3)</sup>	Overvoltage Category III + Surge Protective Device/Metal Oxide Varistor

Property	Value	Notice
Protection function control terminals	SELV, galvanically isolated	
Electromagnetic compatibility		
Interference emission in accordance with:	EN 61800-3:2018	Residential environment (C1) <sup>4)</sup>
Interference immunity in accordance with:	EN 61800-3:2018	Industrial environment (C2)

<sup>1)</sup> TN and TT power supplies with earthed live wires are not permitted.

<sup>2)</sup> For more detailed, product-specific information such as power consumption, dimensions and weights, refer to the technical documentation in the catalogue or Wilo-Select online.

<sup>3)</sup> Over Voltage Category III + Surge Protective Device/Metall Oxid Varistor.

<sup>4)</sup> In the case of 3~ input power supply with motor powers of 2.2 and 3 kW, EMC irregularities can occur under unfavourable circumstances when used in residential environments (C1) with low electrical power in the conducted range. In this case, please contact WILO SE so that together we can find a quick and suitable shutdown measure.

#### Fluids

Water-glycol mixtures or fluids with a different viscosity than pure water increase the power consumption of the pump. Mixtures with a proportion of glycol of > 10 % influence the p-v- and Δp-v characteristic curve and the flow calculation.

#### 4.3 Scope of delivery

- Drive
- Installation and operating instructions and declaration of conformity

#### 4.4 Accessories

Accessories must be ordered separately:

- CIF module PLR for connecting to PLR/interface converter
- CIF module LON for connection to the LONWORKS mains network
- CIF module BACnet
- CIF module Modbus
- CIF module CANopen
- CIF module Ethernet
- Connection M12 RJ45 CIF Ethernet
- Differential pressure kit 4 – 20mA
- Relative pressure kit 4 – 20mA

For a detailed list, consult the catalogue and spare parts documentation.



#### NOTICE

CIF modules may only be plugged in when the pump is de-energised (voltage-free).

## 5 Installation

### 5.1 Personnel qualifications

- Installation/dismantling must be carried out by a qualified technician who is trained in the use of the necessary tools and fixation materials.

### 5.2 Operator responsibilities

- Observe national and regional regulations!
- Observe locally applicable accident prevention and safety regulations of professional and trade associations.
- Provide protective equipment and ensure that the protective equipment is worn by personnel.
- Observe all regulations for working with heavy loads.

**DANGER**

When dismantled, the permanent magnet rotor inside the motor can pose mortal danger for people with medical implants (e.g. pacemakers).

- . Follow the general behavioural guidelines that apply to handling electrical devices!
- . Do not open the motor!
- . Dismantling and installation of the rotor may only be carried out by Wilo customer service! If you have been fitted with a pacemaker, you must not carry out this kind of work!

**DANGER****Risk of fatal injury due to lack of protective device!**

Due to missing protective devices of the drive, electric shock or contact with rotating parts can lead to life-threatening injuries. Before commissioning, safety devices such as inverter cover or coupling covers that were removed must be reinstalled!

**WARNING****Potentially fatal injury due to drive not being installed!**

A life-threatening voltage may be present at the motor contacts! Normal operation of the pump is only permitted with the drive installed. Never connect or operate the pump without the drive mounted!

**WARNING****Danger of death from falling parts!**

The drive itself and drive parts can be extremely heavy. Falling parts pose a risk of cuts, crush injuries, bruises or impacts which can be fatal.

- . Always use suitable lifting equipment and secure parts against falling.
- . Never stand underneath a suspended load.
- . During storage and transport, as well as before all installation and assembly work, ensure that the drive is in a safe position and standing securely.

**WARNING****Personal injury due to strong magnetic forces!**

Opening the motor leads to high, abruptly occurring magnetic forces. This can lead to serious cuts, crushing injuries and bruises. Do not open the motor!

**WARNING****Hot surface!**

There is a risk of burns! Allow the pump to cool down before commencing any work!

#### 5.4 Permitted installation positions and change of the arrangement of components before the installation

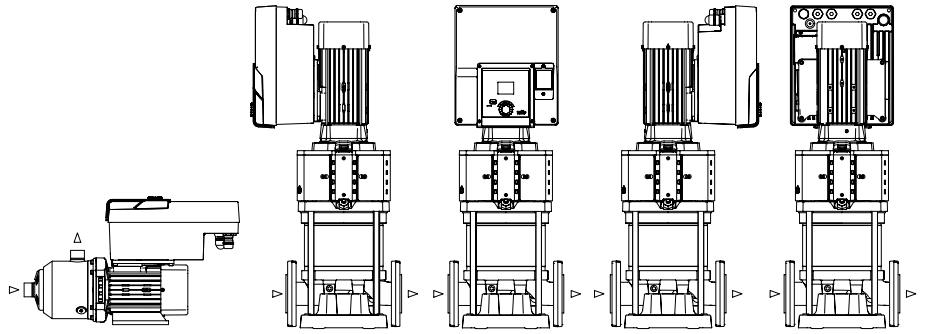

Fig. 4: Arrangement of the components upon delivery

The component arrangement concerning the pump housing is pre-assembled as a factory setting and can be changed at the operating location if required. This may be necessary, for example, in the following cases:

- Ensuring pump venting
- Enabling better operation
- Avoid impermissible installation positions (motor and/or inverter point downwards). In most cases, it is enough to rotate the motor impeller unit relative to the pump housing. The possible arrangement of components is the result of the permitted installation positions.

#### 5.5 Permitted installation positions with horizontal motor shaft

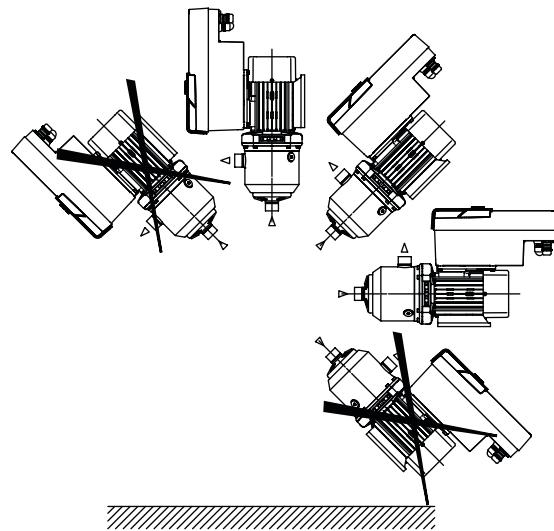

Fig. 5: Permitted installation positions with motor shaft and electronic module facing up (0°)

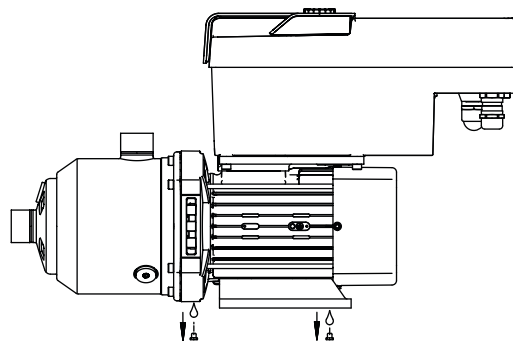

Fig. 6: Condensate drain openings

Only in this position (0°) can condensate be directed away via existing drilled holes in the motor.

## 5.6 Preparing the installation

**DANGER****Danger of death from falling parts!**

The drive parts can be extremely heavy. Falling parts pose a risk of cuts, crush injuries, bruises or impacts which can be fatal.

- . Always use suitable lifting equipment and secure parts against falling.
- . Never stand underneath a suspended load.
- . During storage and transport, as well as before all installation and assembly work, ensure that the pump is in a safe position and standing securely.

**WARNING****Risk of personal injury and property damage due to improper handling!**

- . Never set up the drive unit on unfortified surfaces or surfaces that cannot bear loads.
- . Flush the pipeline system if required. Dirt can cause the pump to fail.
- . Install only after completion of all welding and soldering work and after the pipeline system has been flushed, if required.
- . Observe the minimum axial distance of 100mm between a wall and the fan cover of the motor.
- . Ensure free air access to the heat sink of the electronic module with at minimum an axial distance of 100mm with a wall.

- The drive must be protected from the weather and installed in a frost/dust-free, well-ventilated environment that is not potentially explosive. Observe the instructions in “Intended use” section!
- The drive must be accessible for inspections, maintenance or replacement in the future.
- Install a device for attaching hoisting gear above the set-up site of large drive. Total weight of the drive: see catalogue or data sheet.

**WARNING****Personal injury and property damage due to improper handling!**

Transport lugs mounted on the motor housing can tear out if the load is too heavy. This can lead to serious injuries and damage to the product!

- . Never transport the entire pump with the transport lugs attached to the motor housing.
- . Never use the transport lugs attached to the motor housing to separate or pull out the motor unit.



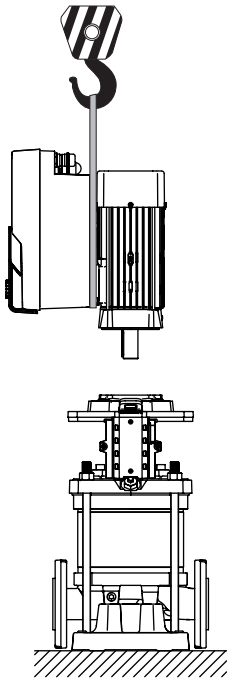

Fig. 7:

### 5.7 Double pump installation

#### Transporting the drive

- Only lift the drive with approved lifting gear (e.g. block and tackle, crane). See also chapter "Transport and temporary storage".
- Transport lugs mounted on the motor housing are only permitted for transporting the motor!



#### NOTICE

##### Simplify subsequent work on the unit!

To ensure the entire unit does not have to be emptied, install shut-off valves upstream and downstream of the pump.



#### CAUTION

##### Material damage due to turbine and generator operation!

Flowing through the pump in the direction of flow or against the direction of flow can cause irreparable damage to the drive. Install a swing check valve on the discharge side of each pump!

A double pump can be two single pumps operated in one common collector pipe.



#### NOTICE

For double pumps in a common collector pipe, one pump should be configured as the main pump. The pressure sensor should be mounted on this pump. The Wilo Net bus communication cable should be also mounted and configured on main pump.

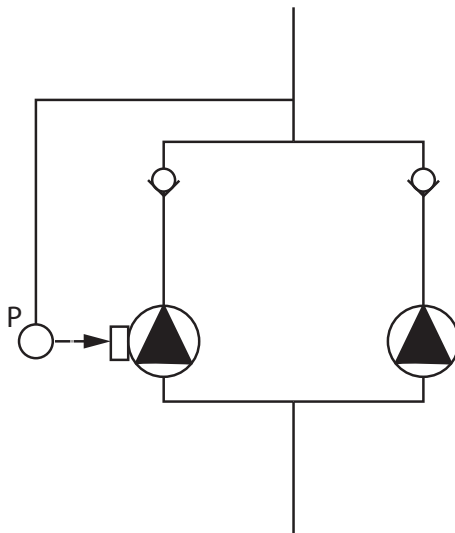

Fig. 8: Example relative pressure sensor connection in common collector pipe

Two single pumps as double pump in common collector pipe:

In the example, the main pump is the left-hand pump in the direction of flow. Connect the pressure sensor to this pump! Connect and configure the two single pumps to form a double pump. See chapter "double pump operation".

The measuring points of the relative pressure sensor must be on discharge side of the double-pump system in the common collector pipe.

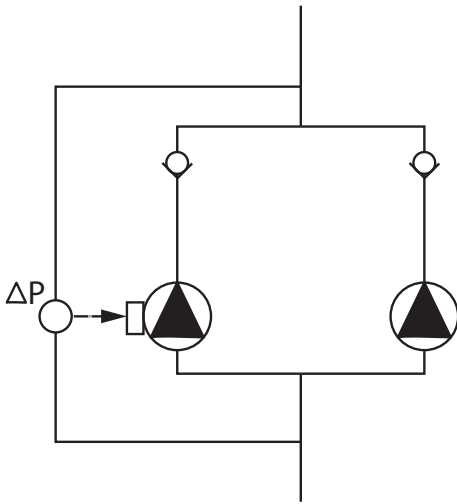

Fig. 9: Example differential pressure sensor connection in common collector pipe

### 5.8 Installation and position of additional sensors to be connected

Two single pumps as double pump in common collector pipe:

In the example, the main pump is the left-hand pump in the direction of flow. Connect the differential pressure sensor to this pump! Connect and configure the two single pumps to form a double pump. See chapter "double pump operation".

The measuring points of the differential pressure sensor must be on the suction and discharge side of the double-pump system in the common collector pipe.

In the following cases, sensor sleeves must be installed in the pipes for the admission of different sensors:

- Pressure sensor
- Other sensors

#### Pressure sensors:

In p-c control mode, the measuring points of the relative pressure sensor should be installed on the discharge side of the pump. Connect the cable connection to analogue input 1.

In dp-c or dp-v control mode, the measuring points of the differential pressure sensors should be installed on the suction and discharge sides of the pump. Connect the cable connection to analogue input 1.

The differential pressure sensor is configured in the pump menu.

In p-v control mode, install the first measuring point of the relative pressure sensor on the discharge side of the pump. Connect the relevant cable connection to analogue input 1. Install the second measuring point of the absolute or relative pressure sensor on the suction side of the pump. Connect the relevant cable connection to analogue input 2.

Possible sensor types on suction side:

- Absolute
- Relative

Possible sensor types on Discharge side:

- Relative

Possible signal types on differential pressure sensors:

- 0 ... 10 V
- 2 ... 10 V
- 0 ... 20 mA
- 4 ... 20 mA



#### NOTICE

Available as an accessory:

Absolute, relative or differential pressure sensor for connection to the pump

#### Other sensors

In "PID control" mode, it's possible to connect other sensor types (Temperature sensor, Flow sensor etc.) compatible with these signal types:

- 0 ... 10 V

- 2 ... 10 V
- 0 ... 20 mA
- 4 ... 20 mA

The cable connection should be connected to analogue input 1.

## 6 Electrical connection



### DANGER

#### **Danger of death due to electrical current!**

##### **The use of a thermal overload protection is recommended!**

Electrical connection may only be carried out by a qualified electrician and in accordance with the applicable regulations!

Adhere to accident prevention regulations!

Before beginning work on the product, make sure that the drive are electrically isolated.

Make sure that no one can turn on the power supply again before work is completed.

Make sure that all energy sources can be isolated and locked. If the drive was switched off by a safety device, it must be secured against switching back on again until the error has been remedied.

Electrical machines must always be earthed. Earthing must be appropriate for the drive and meet the relevant standards and regulations. Earth terminals and fixation elements must be suitably dimensioned.

Connection cables must never touch the piping, pump or motor housing. If it is possible for persons to come into contact with the drive, the earthed connection must also be fitted with a residual current circuit breaker.

Observe the installation and operating instructions for the accessories!



### DANGER

#### **Danger of death!**

Touching live parts will result in serious injuries or death! Even when it is disconnected, high contact voltages can still occur in the electronic module due to non-discharged capacitors. Therefore, work on the electronic module must not be started until 5 minutes have elapsed!

Disconnect all poles of the supply voltage and secure against reconnection!

Check whether all connections (including potential-free contacts) are voltage-free!

Never insert objects (e.g. nail, screwdriver, wire) into openings on the electronic module!

Reinstall removed safety devices (such as module covers)!



### DANGER

#### **Risk of fatal electrical shock! Generator or turbine operation during pump flow!**

Even without the electronic module (without electrical connection), there may be dangerous contact voltage at the motor contacts!

Close the shut-off devices upstream and downstream of the pump!

**DANGER****Risk of fatal electrical shock!**

Water on the upper part of the electronic module can enter the electronic module when it is opened.

Before opening, remove water, e.g. on the display, by wiping it off completely. Avoid water penetration in general!

**CAUTION****Potential danger of death due to electronic module not being installed!**

A life-threatening voltage may be present at the motor contacts! Normal operation of the pump is only permitted with the electronic module installed.

Never connect or operate the pump without the electronic module mounted!

**CAUTION****Property damage caused by improper electrical connection! An inadequate mains design can lead to system failures and cable fires due to mains overload!**

When designing the mains supply with regard to the used cable cross-sections and fuses, pay special attention to the fact that, in multi-pump operation, it is possible that all pumps operate at the same time for short periods.

**CAUTION****Danger of material damage caused by improper electrical connection!**

Ensure that the current type and voltage of the mains connection correspond to the specifications on the pump rating plate.

**Threaded cable glands and threaded cable connections**

There are six cable bushings to the terminal room on the electronic module. In case of drive is delivered with a fan, the cable for its power supply on the electronic module is mounted at the factory. The requirements for electromagnetic compatibility must be observed.

**NOTICE**

Only the threaded cable gland M25 for the mains connection and M20 for the cable of the pressure sensor are installed at the factory. All other required threaded cable glands M20 must be provided by the customer.

**CAUTION**

In order to ensure IP55, unoccupied threaded cable glands must remain closed with the plugs provided by the manufacturer.

When installing the threaded cable gland, make sure that a gasket is installed below the threaded cable gland.

1. Screw in threaded cable glands as required. Observe the tightening torque. See table "Tightening torques".
2. Make sure that a gasket is fitted between the threaded cable gland and the cable bushing.

The combination of threaded cable gland and cable bushing must be made according to the table "Cable connections":

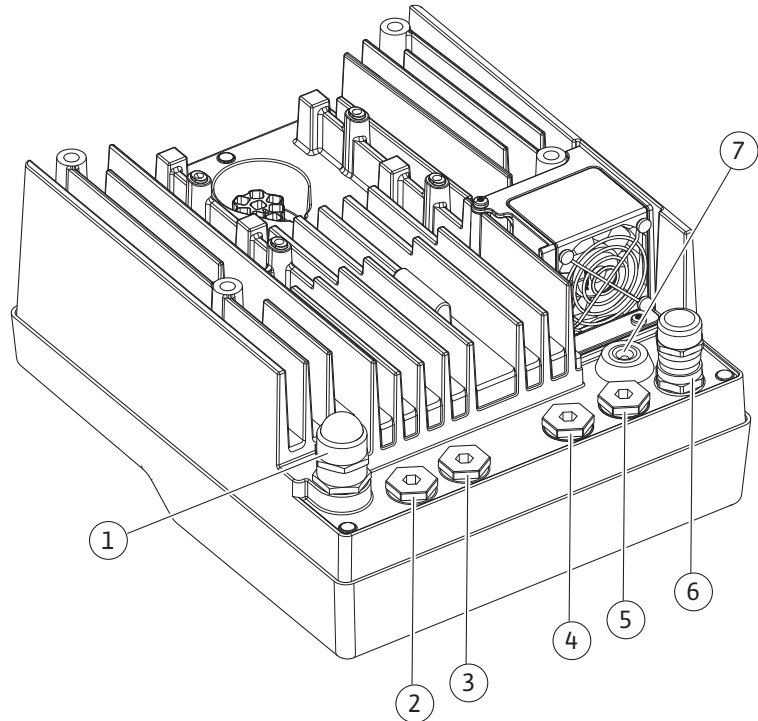

Fig. 10: Threaded cable glands/cable connections

Connection	Threaded cable gland	Cable entry Fig. 10 Item	Terminal no.
Electrical mains connection 3~380 VAC ... 3~440 VAC 1~220 VAC ... 1~240 VAC	Plastic	1	1 (Fig. 11)
SSM 1~220 VAC ... 1~240 VAC (12 V direct current)	Plastic	2	2 (Fig. 11)
SBM 1~220 VAC ... 1~240 VAC (12 V direct current)	Plastic	3	3 (Fig. 11)
Digital input EXT. OFF (24 V direct current)	Metal with shielding	4, 5, 6	11, 12 (Fig. 12) (D11)
Digital input WATER SHORTAGE (24 V direct current)	Metal with shielding	4, 5, 6	11, 12 (Fig. 12) (D11)
Bus Wilo Net (bus communication)	Metal with shielding	4, 5, 6	15 ... 17 (Fig. 12)
Analogue input 1 0 ... 10 V, 2 ... 10 V, 0 ... 20 mA, 4 ... 20 mA	Metal with shielding	4, 5, 6	1, 2, 3 (Fig. 12)

Connection	Threaded cable gland	Cable entry Fig. 10 Item	Terminal no.
Analogue input 2 0 ... 10 V, 2 ... 10 V, 0 ... 20 mA, 4 ... 20 mA	Metal with shielding	4, 5, 6	1, 4, 5 (Fig. 12)
CIF module (bus communication)	Metal with shielding	4, 5, 6	4 (Fig. 17)
Electrical connection of the fan assembled at the factory (24 V direct current)		7	4 (Fig. 11)

Table 4: Cable connections

### Cable requirements

Terminals are intended for rigid and flexible conductors with or without ferrules. When flexible cables are used, the use of ferrules is recommended.

Connection	Terminal cross-section in mm <sup>2</sup> Min.	Terminal cross-section in mm <sup>2</sup> Max.	Cable
Electrical mains connection: 1~	≤ 2.2 kW: 4x1.5	≤ 2.2 kW: 3x4	
Electrical mains connection: 3~	≤ 4 kW: 4x1.5 > 4 kW: 4x2.5	≤ 4 kW: 4x4 > 4 kW: 4x6	
SSM	2x0.2	3x1.5 (1.0**) changeover relay	*
SBM	2x0.2	3x1.5 (1.0**) changeover relay	*
Digital input 1	2x0.2	2x1.5 (1.0**) changeover relay	*
Analogue input 1	2x0.2	2x1.5 (1.0**) changeover relay	*
Analogue input 2	2x0.2	2x1.5 (1.0**) changeover relay	*
Wilo Net	3x0.2	3x1.5 (1.0**) changeover relay	Shielded
CIF module	3x0.2	3x1.5 (1.0**) changeover relay	Shielded

Table 5: Cable requirements

\* Cable length ≥ 2m: use shielded cables.

\*\* When using ferrules, the maximum cross-section of the terminal for communication interfaces is reduced to 0.25... 1mm<sup>2</sup>.

In order to comply with electromagnetic compatibility standards, the following cables must always be shielded:

- Cable for EXT. OFF / LACK OF WATER at digital inputs
- External control cable sensors at analogue inputs
- Double pump cable with two single pumps (bus communication)
- CIF module to the building automation (bus communication): The shield is connected to the cable entry on the electronic module (Fig. 10).

### Terminal connections

Terminal connections for all cable connections in the electronic module correspond to push-in technology. They can be opened with a screwdriver type slot SFZ1 – 0.6x0.6 mm.

### Length of cable to strip

The stripping length of the cables for the terminal connection is 8.5 mm... 9.5 mm.

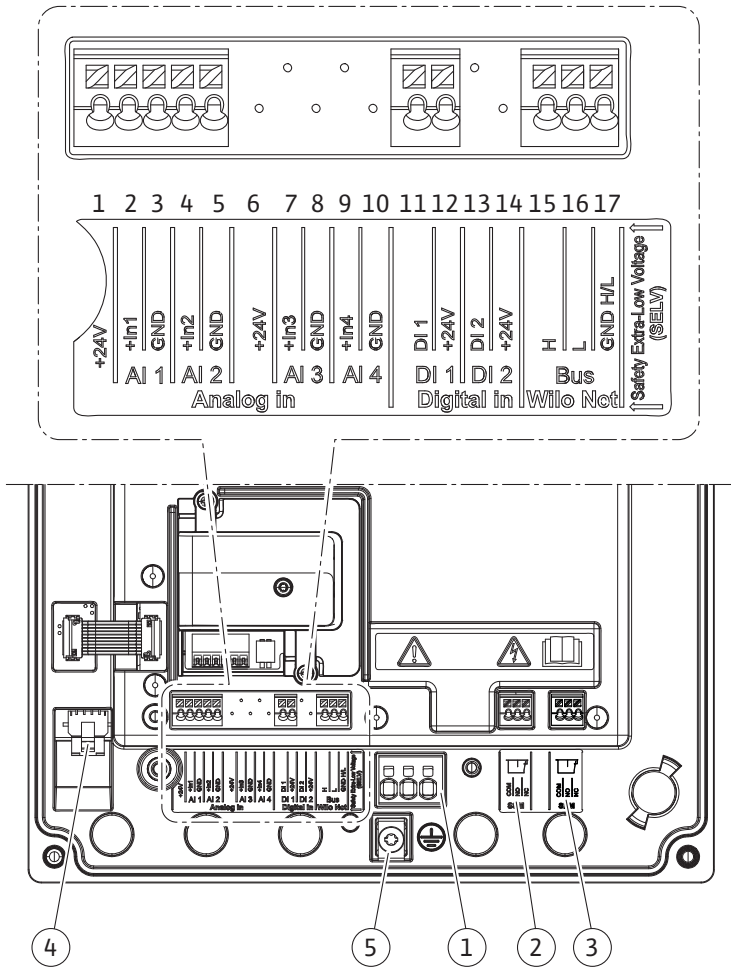

Fig. 11: Overview of terminals in the module

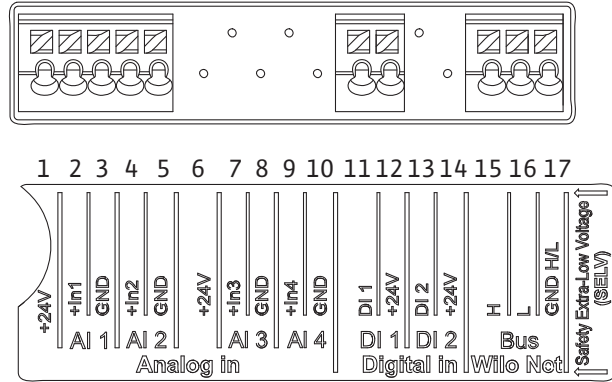

Fig. 12: Terminals for analogue inputs, digital inputs and Wilo Net



**NOTICE**

**Wilo Net AI3, AI4 and DI2 are not assigned**

## Terminal assignment

Name	Assignment	Notice
Analogue IN (AI1)	+ 24V (terminal: 1) + In1 → (terminal: 2) - GND (terminal: 3)	Type of signal: • 0 – 10V • 2 – 10V
Analogue IN (AI2)	+ In2 → (terminal: 4) - GND (terminal: 5)	• 0 – 20mA • 4 – 20mA Dielectric strength: 30VDC/24VAC Power supply: 24 V DC: maximum 50 mA
Digital IN (DI1)	DI1 → (terminal: 11) + 24V (terminal: 12)	Digital inputs for potential-free contacts: • Maximum voltage: < 30 V DC/24 V AC • Maximum loop current: < 5 mA • Operating voltage: 24VDC • Operating loop current: 2 mA per input
Wilo Net	↔ H (terminal: 15) ↔ L (terminal: 16) GND H/L (terminal: 17)	
SSM	COM (terminal: 18) ← NO (terminal: 19) ← NC (terminal: 20)	Potential-free changeover contact Contact load: • Permitted minimum: SELV 12VAC/DC, 10mA • Permitted maximum: 250VAC, 1A, 30VDC, 1A
SBM	COM (terminal: 21) ← NO (terminal: 22) ← NC (terminal: 22)	Potential-free changeover contact Contact load: • Permitted minimum: SELV 12VAC/DC, 10mA • Permitted maximum: 250VAC, 1A, 30VDC, 1A
Mains connection		

## 6.1 Mains connection

**NOTICE**

Nationally applicable guidelines, standards and regulations as well as the requirements of local energy supply companies must be observed!

**NOTICE**

Tightening torques for the terminal screws, see "Tightening torques" table. Only use a calibrated torque wrench!

1. Observe the current type and voltage on the rating plate.
2. Establish the electrical connection via a fixed connection cable equipped with a connector device or an all-pole switch with a contact opening width of at least 3 mm.
3. To protect against leakage and for strain relief to the threaded cable gland, use a connection cable with sufficient outer diameter.
4. Guide the connection cable through the M25 threaded cable gland (Fig. 10, Item 1). Threaded cable gland with the specified torques.



5. The cables near the screwed connection are to be bent to form a drain loop, to drain any accumulated drips.
6. Lay the connection cable in such a way that it touches neither the pipes nor the pump.



### NOTICE

If flexible cables are used for the mains connection or communication connection, use wire end ferrules!

Unoccupied threaded cable glands must remain closed with the plugs provided by the manufacturer.



### NOTICE

It is preferable to switch on or off the pump with the digital input (Ext. Off) instead of the main power supply.

## Main terminal: main earth connection

### Line terminal connection

Line terminal for 3~ mains connection with earthing

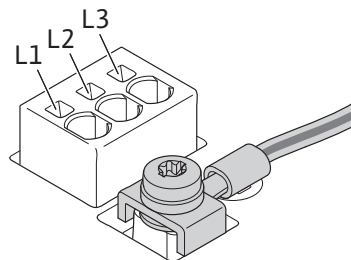

Line terminal for 1~ mains connection with earthing

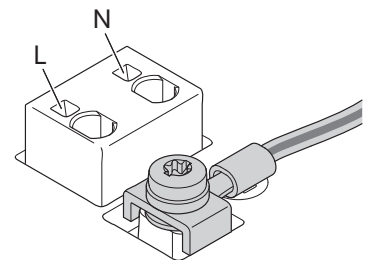

### Connection of protective earth conductor

When using a flexible connection cable, use a ring lug for the earth wire.

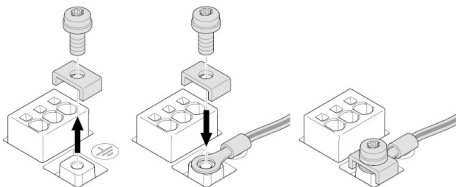

Fig. 13: Flexible connection cable

When using a rigid connection cable, connect the earth wire in a U-shape.

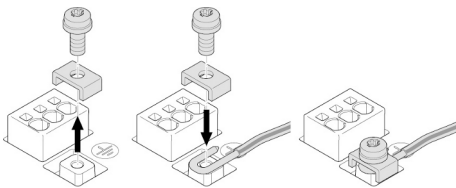

Fig. 14: Rigid connection cable

### Residual-current device (RCD)

**A frequency converter must not be protected by a residual-current device.**

Frequency converters can impair the function of residual-current-operated protection circuits.



### NOTICE

This product can cause a direct current in the protective earth conductor. Where a residual-current device (RCD) or a residual-current monitoring device (RCM) is used for protection in the event of direct or indirect contact, only a type B RCD or RCM is permitted on the power-supply side of this product.

Labelling:



Trigger current: > 30 mA

Fuse protection on mains side: max. 25 A (for 3~)

Mains-side fuse protection: max. 16 A (for 1~)

The mains-side fuse protection must correspond to the electrical configuration of the pump.

### Circuit breaker

The use of a circuit breaker is recommended.



#### NOTICE

Circuit breaker trigger characteristic: B

Overload:  $1.13-1.45 \times I_{nom}$

Short-circuit:  $3-5 \times I_{nom}$

## 6.2 SSM and SBM connection

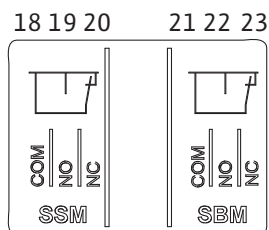

Fig. 15: Terminals for SSM and SBM

SSM (collective fault signal) and SBM (collective run signal) are connected to terminals 18 ... 20 and 21 ... 23.

The cables of the electrical connection for SBM and SSM do **not** have to be shielded.



#### NOTICE

A maximum of 230 V may be applied between the contacts of the relays of SSM and SBM, never 400 V!

When using 230 V as a switching signal, the same phase must be used between the two relays.

SSM and SBM are designed as changeover contacts and can each be used as a normally open contact or normally closed contact. When the pump is voltage-free, the contact is normally closed contact. The following applies to SSM:

- If a fault is present, the contact at NC is normally open contact.
- The converter bridge to NO is closed.

The following applies to SBM:

- Depending on the configuration, the contact is set to NO or NC.

## 6.3 Connection of digital, analogue and bus inputs

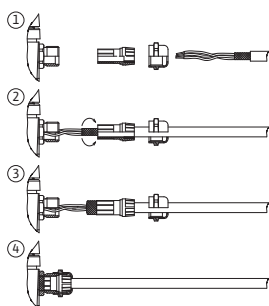

Fig. 16: Shield clamp

The cables of the digital inputs, analogue inputs and bus communication must be shielded via the metal threaded cable gland of the cable entry 4, 5 and 6 (Fig. 10). When used for extra-low voltage cables, up to three cables can be passed through for each threaded cable gland. Use the appropriate multiple sealing inserts for this purpose.



#### NOTICE

If two cables have to be connected to one 24 V supply terminal, provide a solution on-site!

Only one cable per terminal may be connected to the pump!



#### NOTICE

The terminals of the analogue inputs, digital inputs and Wilo Net meet the "safe isolation" requirement (according to EN 61800-5-1) to the mains terminals, the terminals SBM / SSM (and vice versa).



#### NOTICE

The control is designed as a SELV (Safe Extra Low Voltage) circuit. In this way, the (internal) supply fulfils the requirements for safe separation of the supply. GND is not connected to PE.



## NOTICE

The drive can be switched on and off without intervention from the operator. This can be done, for example, using the control function, by external BMS connection or also by the EXT. OFF function.

### 6.4 Differential pressure sensor connection

If the differential pressure sensor is connected on-site, carry out the cable assignment as follows:

Cable wire	Terminal	Function
1	+24 V	+24 V
2	In1	Signal
3	GND	Earth

Table 6: Connection; differential pressure sensor cable



## NOTICE

For a double pump installation, connect the pressure sensor to the main pump! The measuring points of the pressure sensor must be on discharge side of the double-pump system in the common collector pipe. See chapter "Double pump installation".

### 6.5 Wilo Net connection

Wilo Net is a Wilo system bus used for establishing communication between Wilo products:

- Two single pumps as a double pump in the common collector pipe
- Wilo-Smart Gateway and pump

For details on connection, see the detailed instructions at [www.wilo.com](http://www.wilo.com)!

In order to establish the Wilo Net connection, the three Wilo Net terminals (H, L, GND) must be wired with a communication line from pump to pump. Incoming and outgoing cables are clamped in a terminal.

Cable for Wilo Net communication:

To ensure interference immunity in industrial environments (IEC 61000-6-2), use a shielded CAN bus cable and an EMC-compatible cable entry for the Wilo Net cables. Connect the shield to earth at both ends. For optimum transmission, the data cable pair (H and L) must be twisted at Wilo Net and have a characteristic impedance of 120 ohms.

#### Wilo Net termination

Pump	Terminal Wilo Net	Wilo Net address
Pump 1	Active	1
Pump 2	Inactive	2

Number of Wilo Net pump participants:

A maximum of 21 participants can communicate in the Wilo Net. Each single node is one pump participant. That means that one double pump consists of two pump participants.

Integration of a Wilo Smart Gateway also requires a separate node.

For further descriptions, see section "Application and function of the Wilo Net interface".

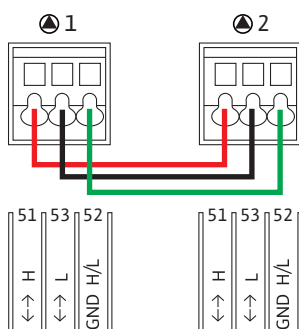

### 6.6 Turn of the display



## CAUTION

### Risk of material damages

If the graphic display is not fixed properly and the electronic module is not installed correctly, protection class IP55 is no longer ensured.

Ensure that no gaskets are damaged!

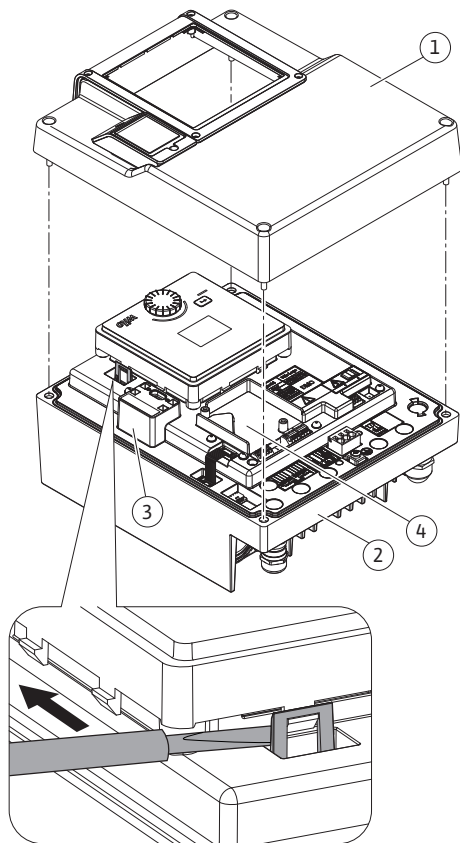

Fig. 17: Electronic module

The graphic display can be turned in 90° steps. To do this, open the upper part of the electronic module using a screwdriver.

The graphic display is fixed in position by two snap-in hooks.

1. Carefully open the snap-in hooks with a tool (e.g. screwdriver).
2. Turn the graphic display to the desired position.
3. Fix the graphic display with the snap-in hooks.
4. Fit the upper part of the module again. Observe the screw tightening torques on the electronic module.

Component	Fig./item Screw (nut)	Screw drive/thread	Tightening torque [Nm] ± 10 % (unless otherwise stated)	Information Installation
Electronic module upper part	Fig. 17, Item 1 Fig. 1, pos. 2	M5	4.5	
Threaded cable gland union nut	Fig. 10, Item 1	M25	11	*
Threaded cable gland	Fig. 10, Item 1	M25x1.5	8	*
Threaded cable gland union nut	Fig. 10, Item 6	M20x1.5	6	*
Threaded cable gland	Fig. 10, Item 6	M20x1.5	5	
Power terminals and control terminals	Fig. 11	Pusher	Slot 0.6x3.5	**
Earthing screw	Fig. 11, Item 5	M5	4.5	
CIF module	Fig. 17, Item 4	PT 30x10	0.9	
Wilo-Connectivity Interface cover	Fig. 2, Item 5	M3x10	0.6	
Module fan	Fig. 47	IP10/AP 40x12/10	1.9	

Table 7: Tightening torques for electronic module

\* Tighten when installing the cables.

\*\* Press with screwdriver to plug and unplug the cable.

## 7 Installation of CIF module



### DANGER

#### Risk of fatal electrical shock!

Immediate danger of death if live components are touched!  
Check whether all connections are voltage-free!

CIF modules (accessories) are used for communication between pumps and building management systems. CIF modules are attached in the electronic module (Fig. 17, Item 4).

- For double pumps in common collector pipe applications in which the electronic modules are connected to each other through the Wilo Net, only the main pump also requires a CIF module.



### NOTICE

When using CIF module Ethernet, the use of the accessory "Connection M12 RJ45 CIF-Ethernet" is recommended. It is required for easy disconnection of the data cable connection via the SPEEDCON bush outside the electronic module in the event of pump maintenance.



### NOTICE

Explanations on commissioning as well as application, function and configuration of the CIF module on the pump are described in the installation and operating instructions for the CIF modules.

## 8 Commissioning

- Electrical work: A qualified electrician must carry out the electrical work.
- Installation/dismantling: The technician must be trained in the use of the necessary tools and fixation materials.
- The product must be operated by persons who have been instructed on how the complete system functions.



### DANGER

#### **Danger of death due to lack of protective devices!**

Due to missing protective devices of the electronic module or in the range of the coupling/motor, electric shock or contact with rotating parts can lead to life-threatening injuries.

- Before commissioning, safety devices such as electronic module covers or coupling covers that were removed must be reinstalled!
- An authorised technician must check the functionality of the safety devices on the pump and motor prior to commissioning!
- Never connect the pump without the electronic module!



### CAUTION

#### **Danger of injury due to fluid shooting out and components coming loose!**

Not installing the pump/system correctly can lead to serious injuries during commissioning!

- Carry out all work carefully!
- Keep a safe distance during commissioning!
- Always wear protective clothing, protective gloves and protective goggles when working.

### 8.1 Procedure after switching on the power supply during initial commissioning

As soon as the power supply is switched on, the display is initialised. This can take a few seconds. After the initialization is complete, settings can be made. See section 10 "Control setting".

At the same time, the pump motor starts to run.



### CAUTION

#### **Dry running will destroy the mechanical seal! It may cause leakage.**

Ensure that a dry run of the pump is not possible.

**To avoid starting the motor when switching on the power supply during initial commissioning:**

A cable bridge is set at the factory at digital input DI 1. The DI 1 is factory-installed as Ext. Off active. To prevent the motor from starting up for the first time, the cable bridge must be removed before the power supply is switched on for the first time.

After initial commissioning, the digital input DI 1 can be set as required via the initialised display. If the digital input is switched to inactive, the cable bridge does not have to be set again to start the motor. See section 13.3 “Application and function of the digital control input”.

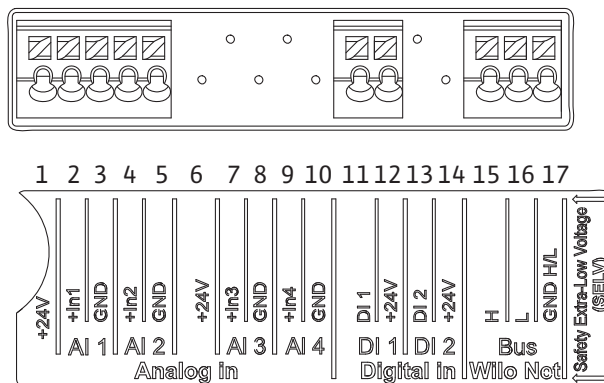

Fig. 18:

**8.2 Description of the operating elements**

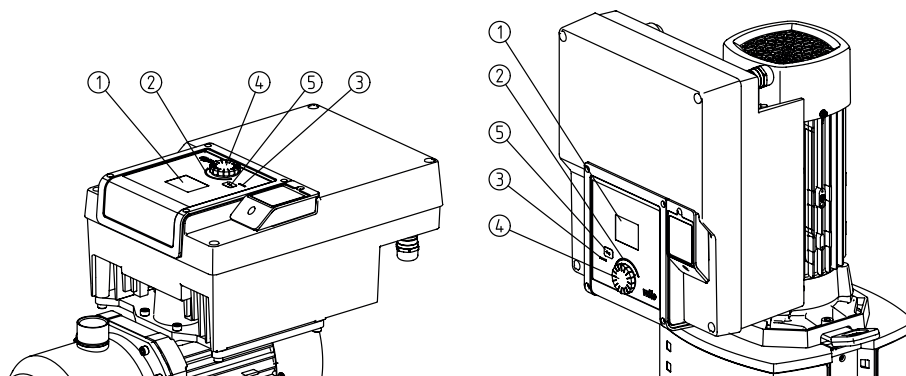

Fig. 19: Operating elements

Item	Name	Explanation
1	Graphic display	Provides information about settings and pump status. User interface for setting the pump.
2	Green LED indicator	LED is lit up: Pump is supplied with voltage and ready for operation. There are no warnings and no faults.
3	Blue LED indicator	LED is lit up: Pump is influenced externally via an interface, e.g. by: <ul style="list-style-type: none"> <li>• Setpoint setting via Analog input AI1 ... AI2</li> <li>• Intervention of building automation via binary input DI1 or bus communication</li> </ul> Flashes with active double pump connection.
4	Operating button	Navigate menus and edit content by turning and pressing.
5	Back button	Menu navigation: <ul style="list-style-type: none"> <li>• To go back to the previous menu level (briefly press once).</li> <li>• To go back to the previous settings (briefly press once).</li> <li>• Return to the main menu (press and hold 1x, &gt;2seconds).</li> </ul> Switches the key lock (*) on or off (>5 seconds) when pressing the operating button.

Table 8: Description of operating elements

(\*) The configuration of the key lock makes it possible to protect the pump setting from being changed on the display.

## 8.3 Pump operation

### 8.3.1 Adjusting the pump output

The system was designed for a certain duty point (full load point, calculated maximum heating or cooling power demand). During commissioning, the pump output (delivery head) is set according to the duty point of the system. The factory setting does not correspond to the output required for the system. The required pump capacity is determined with the help of the pump curve diagram for the selected pump type (e.g. from the data sheet).



#### NOTICE

For water applications, the flow rate value shown in the display or output to the building management system applies. For other fluids, this value only reflects the tendency. If no pressure sensor is installed, the pump cannot indicate a volume flow value.

### 8.3.2 Settings on pump

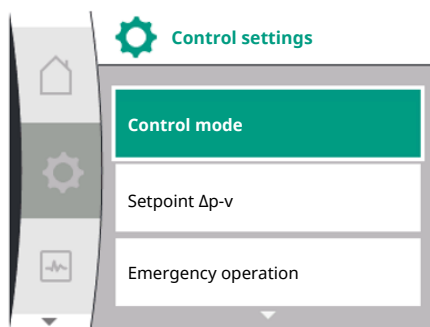

Fig. 20: Green focus: Navigation in menu

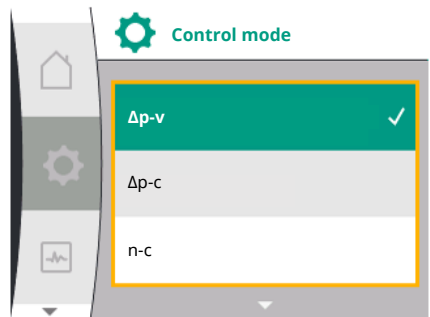

Fig. 21: Yellow focus: Change settings

Carry out settings by turning and pressing the operating button. Turn the operating button to the left or right to browse the menus or configure settings. A green focus indicates navigation in the menu. A yellow focus indicates a configuration of settings.

- Green focus: Navigation in menu
- Yellow focus: Change settings
- Turn  $\checkmark$ : menu selection and parameter setting.
- Press  $\downarrow$ : Activation of menus or confirming settings.
- Press the Back button  $\leftarrow$  (table "Description of operating elements") to change the focus back to the previous focus. Consequently, the focus moves one level further up in the structure or to a previous setting.
- Pressing the Back button  $\leftarrow$  after having changed a setting (yellow focus) without confirming the changed value returns the focus to the previous focus. The adjusted value will be discarded. The previous value remains unchanged.
- If the back button  $\leftarrow$  is pressed for more than 2 seconds, the Home screen opens and the pump can be operated from the main menu.



#### NOTICE

The modified settings are stored in memory after a 10s delay. If a power supply interruption occurs within this time, these settings will be lost.



#### NOTICE

If there are no warning or error messages, the display on the electronic module will switch off 2 minutes after the last time it was operated.

– If the operating button is pressed or turned again within 7 minutes, the previously exited menu will appear. You can continue to configure settings.

– If the operating button is not pressed or turned for more than 7 minutes, any unconfirmed settings will be lost. Pressing the button again opens the home screen on the display and the pump can be operated from the main menu.

### 8.3.3 Initial settings menu

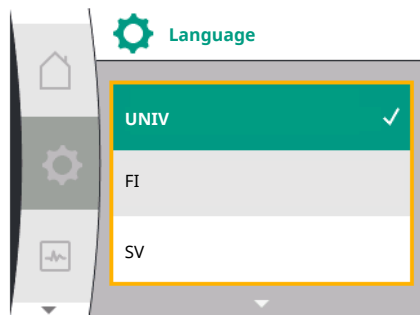

Fig. 22: Settings menu

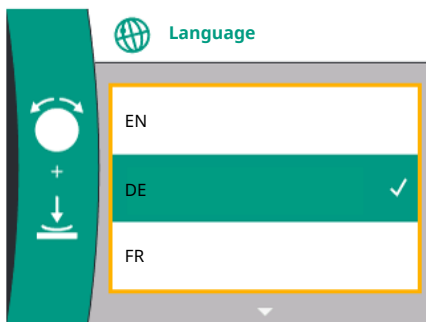

Fig. 23: Initial settings menu

The settings menu will appear in the display during initial commissioning of the pump. Initial settings menu with all available languages (display scrolled down by green button) The following languages can be selected:

Language abbreviations	Language
EN	English
EN	German
FR	French
IT	Italian
ES	Spanish
UNIV	Universal
FI	Finnish
SV	Swedish
PT	Portuguese
NO	Norwegian
NL	Dutch
DA	Danish
PL	Polish
HU	Hungarian
CS	Czech
RO	Romanian
SL	Slovenian
HR	Croatian
SK	Slovak
SR	Serbian
LT	Latvian
LV	Lithuanian
ET	Estonian
RU	Russian
UK	Ukrainian
BG	Bulgarian
EL	Greek
TR	Turkish



#### NOTICE

In addition to the languages, there is a neutral number code "Universal" in the display that can be selected as an alternative language. The number code is listed and explained in tables next to the display texts. Factory setting: English



#### NOTICE

After selecting a language other than the one currently set, the display may switch off and restart. During this process, the green LED flashes. After the display has been restarted, selection list appears with the newly selected language activated. This process can take up to approx. 30 seconds.

After selecting the language, the initial setting menu is exited. The display changes to the main menu. The pump runs in the factory setting.





**NOTICE**

The factory setting is the basic control mode “constant speed”.

**8.3.4 Main menu**

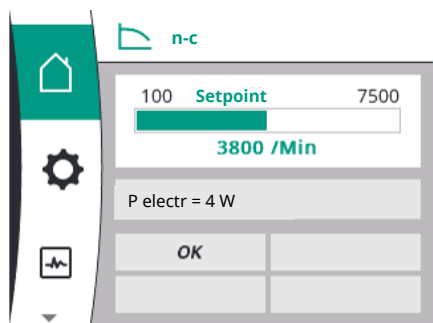

Fig. 24: Main menu

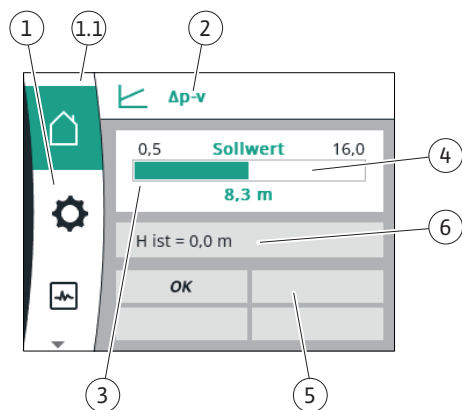

Fig. 25: Home screen

The pump changes to the main menu when you exit the first settings menu.

**Meaning of the main menu symbols in the display**

	Universal	Display text
	Home screen	Home screen
	1.0	Settings
	2.0	Diagnostics and measured values
	3.0	Factory setting

**Main menu "Home screen"**

Setpoints can be changed in the “Home screen” menu.

The selection of the home screen is done by turning the operating button to the “House” symbol.

Pressing the operating button activates the setpoint adjustment. The frame of the changeable setpoint becomes yellow. The setpoint is changed by turning the operating button right or left. The changed setpoint is confirmed by pressing the operating button again. The pump accepts the value and the display returns to the main menu.

- Pressing the back button without confirming the changed setpoint will not change the setpoint.

The pump shows the main menu with unchanged setpoint.

Item	Name	Explanation
1	Main menu overview	Selection of different main menus
1.1	Status area: Error, warning or process information display	Indicates an on-going process, warning or error message. Blue: Process or communication status display (CIF module communication) Yellow: Warning Red: Fault  Grey: There are no processes running in the background, there are no warning or error messages.
2	Title bar	Display of the currently set control mode.
3	Setpoint display field	Displays currently configured setpoints.
4	Setpoint editor	Yellow frame: You have pressed the operating button to open the setpoint editor and change the value.
5	Active influences	Display of influences on set control mode, E.g. EXT. OFF. Up to four active influences can be displayed.
6	Operating data and measurement area	Shows current operating data and measured values. The displayed operating data depend on the set control mode. They are displayed alternately.

Table 9: Home screen

**Main menu**

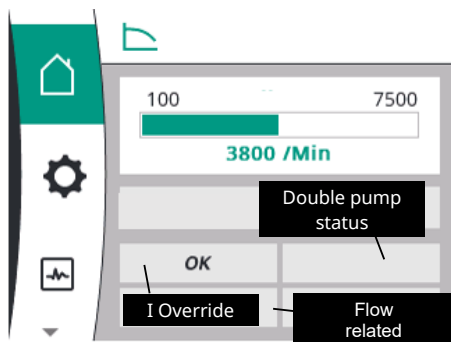

## Home screen – Active influence

The following tables list the displays triggered on the Home Screen by the Active Influences (overrides):

Fig. 26: Home screen – Active influence

Designation (from highest to lowest priority)	Displayed symbols	Description
Error		Error active, motor stops
Pump kick		Pump kick active
EXT. OFF	<b>OFF</b>	Digital input EXT. OFF is active
Pump operation OFF	<b>OFF</b>	Switched Off via manual Pump On/Off
Setpoint OFF	<b>OFF</b>	Analogue signal OFF
Substitute speed		Pump runs at Fallback speed
Fallback Off	<b>OFF</b>	Replacement mode active, but set to motor stop
No active influences	<b>OK</b>	No active influences

The following table lists Active Influences “Double Pump Status” indicated in the Home Screen:

Symbol (from highest to lowest priority)	Displayed symbols	Description
Off Partner Issue		The other pump is in error state and this pump is not running (due to current setting, control state or error)
Partner Issue		The other pump is in error state and this pump is running
Duty/Standby Off		The double pump is in Duty/Standby operation and both pumps are not running (due to current setting or control state)
Duty/Standby This Pump		The double pump is in Duty/Standby operation, this pump is running and the other pump is not running
Duty/Standby Other Pump		The double pump is in Duty/Standby operation, this pump is not running (due to control state or error) and the other pump is running

The following table lists Active Influences “Flow Related” indicated on the Home Screen:

Symbol (from highest to lowest priority)	Displayed symbols	Description
Zero Flow Detection	<b>STOP</b>	Zero flow detected, pump stopped (off)
Limitation of the hydraulic output		Limitation of the hydraulic output
Motor Temperature Limitation		Motor Temperature Limitation
Motor Limitation Voltage Mains		Motor Limitation Voltage Mains
Motor Limitation Current Motor Phase		Motor Limitation Current Motor Phase

Symbol (from highest to lowest priority)	Displayed symbols	Description
Motor Limitation Voltage Dc Link	↑	Motor Limitation Voltage Dc Link
Motor Limitation Power Mains	↑	Motor Limitation Power Mains
None	↑	No Flow related influence

### Sub-menu

Each sub-menu is made up of a list of sub-menu items.

The title lists an additional sub-menu or a downstream settings dialogue.

### Main menu “Settings”

Different settings can be made and changed in the “Settings” menu ⚙️.

- The selection of the “Settings” menu is done by turning the operating button to the “Gear wheel” symbol.
- Confirm selection by pressing the operating button. Selectable sub-menus will be displayed.
- Select a sub-menu by turning the operating button right or left. The selected sub-menu is marked in colour.
- The selection is confirmed by pressing the operating button. The selected submenu or downstream settings dialogue appears.

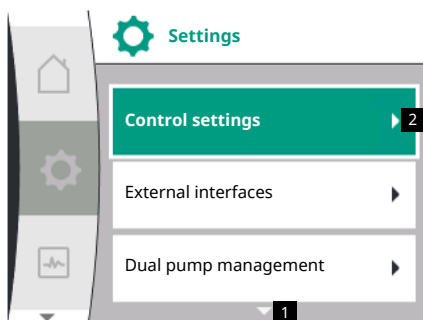

### NOTICE

If there are more than three sub-menu items, an arrow above or below the visible menu items shows that. Turn the operating button in the corresponding direction to open the sub-menu items on the display.

An arrow **1** above or below a menu area indicates that additional sub-menu items are available in this area. These sub-menus can be accessed by turning ↶↷ the operating button.

An arrow **2** pointing to the right in a sub-menu item indicates that another sub-menu is available. Pressing ↶↷ the operating button will open this sub-menu.

If an arrow to the right is missing, a settings dialogue is reached by pressing the operating button.



### NOTICE

A short press of the back button ↶ in a sub-menu will take you back to the previous menu.

A short press of the back button ↶ in the main menu will take you back to the home screen. If there is an error, pressing the back button ↶ will take you to the error display (see section “Error messages”).

If there is an error, long press (>1 second) of the back button ↶ takes you back to the home screen or to the error screen from any settings dialogue and from any menu level.

### Settings dialogues

Settings dialogues have been highlighted with a yellow frame and show the current setting. The highlighted setting is changed by turning the operating button right or left. The setting is confirmed by pressing the operating button. The focus returns to the menu you opened. If you do not turn the operating button before pressing, the previous setting remains unchanged.

One or more parameters can be set in the settings dialogues.

- If only one parameter can be set, the focus returns to the menu you opened after having confirmed the parameter value (pressing the operating button).

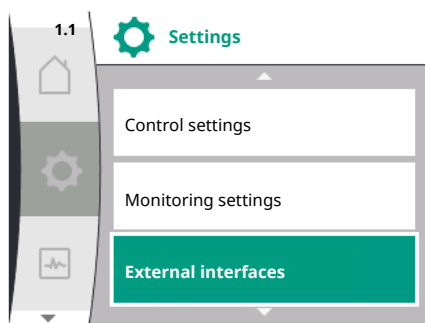
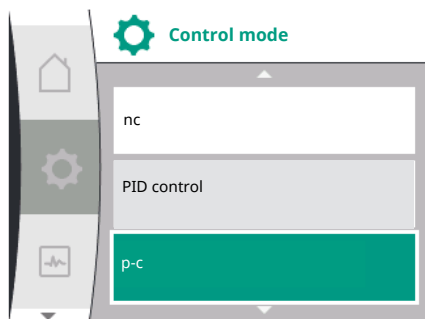

Fig. 27: Main menu status display

- If several parameters can be set, the focus changes to the next parameter after having confirmed a parameter value. If you confirm the last parameter in the settings dialogue, the focus returns to the menu you opened.
- Press the Back button  $\leftarrow$  to return the focus to the previous parameter. The previously changed value will be discarded because it has not been confirmed.
- Press the operating button to check set parameters and switch between them. In this process, existing parameters are once again confirmed, but not changed.



## NOTICE

Pressing the operating button without selecting another parameter or value confirms the existing setting.

Pressing the back button  $\leftarrow$  rejects a current adjustment and keeps the previous setting.

The menu changes to the previous setting or previous menu.

## Status area and status displays

The status area is located on the left side above the main menu area 1.1.

When a status is active, status menu items can be displayed and selected in the main menu.

Turning the operating button to the status area will display the active status.

If an active process is quit or discarded, the status display is hidden again.

There are three different classes of status displays:

1. Display process:  
Running processes are marked in blue.  
Processes cause the pump operation to deviate from the set control.
2. Display warning:  
Warning messages are marked in yellow. The function of the pump is restricted when there is a warning (see the “Warning messages” section).  
Example: cable break detection on analogue input.
3. Display error:  
Error messages are marked in red. If there is a fault, the pumps stops operating (see the “Error messages” section). Example: blocking rotor.

Further status displays, if available, can be displayed by turning the operating button to the corresponding symbol.



Symbol	Meaning
	Error message <b>Pump stopped!</b>
	Warning message <b>Pump operation restricted!</b>
	Communication status: A CIF module has been installed and is active. <b>Pump in control mode, monitoring and control by building automation available.</b>

Table 10: Potential data displayed in the status area



## NOTICE

A set control mode is interrupted when a process is running. The pump starts to run in the set control mode once the process is ended.



## NOTICE

### Behaviour of the back button in case of an error message of the pump.

A repeated or long press of the back button  $\leftarrow$  in case of an error message will take you to "Error" status display and not back to the main menu. The status area is marked in red.

## 9 Control settings

Overview of the terms in the display for selecting the control settings in the available languages:

Universal	Display text
<b>1.0</b>	<b>Settings</b>
<b>1.1</b>	<b>Control settings</b>
<b>1.1.1</b>	<b>Control mode</b>
$\Delta p-v$	$\Delta p-v$
$\Delta p-c$	$\Delta p-c$
n-c	n-c
PID control	PID control
p-c	p-c
p-v	p-v
<b>1.1.2</b>	<b>Setpoint</b>
<b>1.1.2 PID</b>	<b>Setpoint PID</b>
<b>1.1.3 Kp</b>	<b>Parameter Kp</b>
<b>1.1.4 Ti</b>	<b>Parameter Ti</b>
<b>1.1.5 Td</b>	<b>Parameter Td</b>
<b>1.1.6</b>	<b>Controller inversion</b>
<b>1.1.7</b>	<b>Emergency operation mode</b>
OFF	Pump OFF
ON	Pump ON
<b>1.1.8</b>	<b>Emergency operation speed</b>
<b>1.1.9</b>	<b>Setpoint source</b>
1.1.9/1	Internal setpoint
1.1.9/2	Analog input (AI2)
1.1.9/3	CIF module
<b>1.1.10</b>	<b>Substitute setpoint</b>
<b>1.1.11</b>	<b>No-Flow Stop: ON/OFF</b>
<b>1.1.12</b>	<b>No-Flow Stop: Limit value</b>
<b>1.1.13</b>	<b>Zero flow</b>
1.1.13/1	Zero flow test: ON/OFF
1.1.13/2	Zero flow due to overpressure: ON/OFF
1.1.13/3	Zero flow due to overpressure: Pump switch-off limit value
1.1.13/4	Zero flow: Pump switch-off delay
1.1.13/5	Zero flow: Pump restart limit value
<b>1.1.15</b>	<b>Pump ON/OFF</b>
<b>1.1.16</b>	<b>Setpoint p-v</b>
Design volume flow	Design volume flow
Setpoint zero flow	Setpoint zero flow
OFF	Switched OFF
ON	Switched on

## 9.1 Control functions

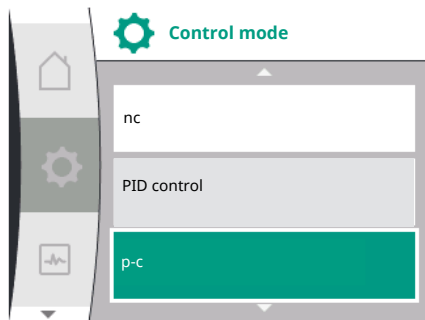

The following control functions are available:

- Constant differential pressure  $\Delta p\text{-c}$
- Variable differential pressure  $\Delta p\text{-v}$
- Constant speed (n-c)
- PID control
- Constant pressure p-c
- Variable pressure p-v

### Constant differential pressure $\Delta p\text{-c}$

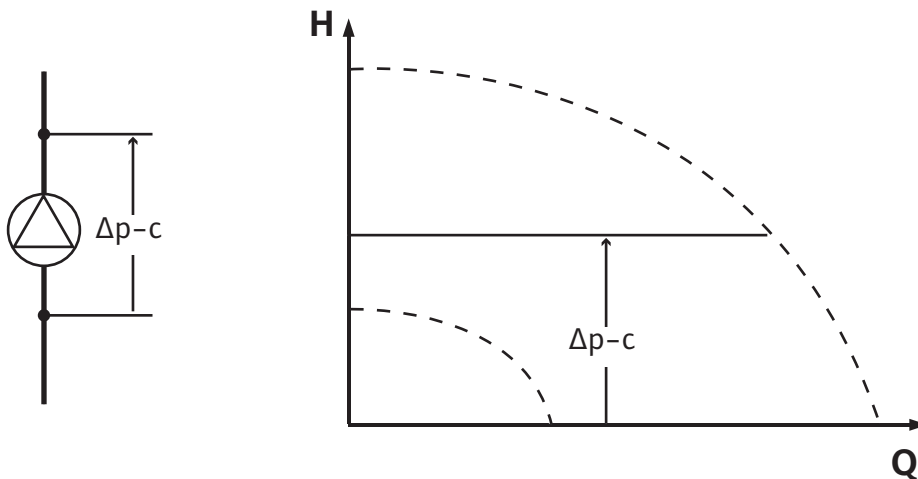

The control keeps the differential pressure created by the pump constant at the selected setpoint  $H_{\text{setpoint}}$  whatever the delivery rate required by the installation.

A relative differential pressure sensor is used for control (sensor: accuracy:  $\leq 1\%$ ; using is the range of 30 % to 100 %).

### Differential pressure variable $\Delta p\text{-v}$

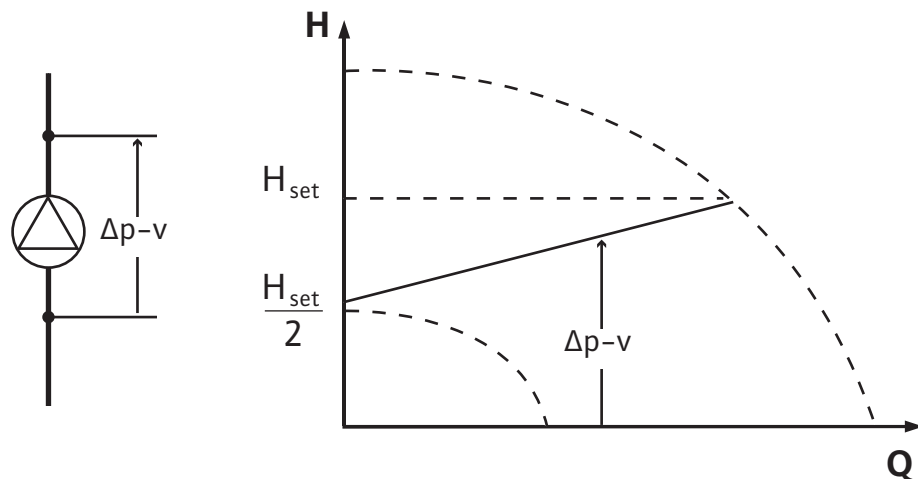

The control keeps the differential pressure created by the pump constant above the permitted flow rate at the selected differential pressure setpoint  $H_{\text{setpoint}}$  up to the maximum characteristic curve.

Assuming a maximum required delivery head at the design point, the pump variably adjusts the pump output to the required volume flow. The volume flow varies due to the open and closed valves on the consumer circuits. The pump output is adjusted to the requirements of the consumer load and the energy requirement is reduced.

A relative differential pressure sensor is used for control (sensor: accuracy:  $\leq 1\%$ ; using is the range of 30 % to 100 %).

### Constant speed (n-c / factory setting)

The speed of the pump is kept at a set constant speed.

**User-defined PID control**

The pump controls based on a user-defined control function. The PID control parameters  $K_p$ ,  $T_i$  and  $T_d$  must be specified manually.

**Constant pressure p-c**

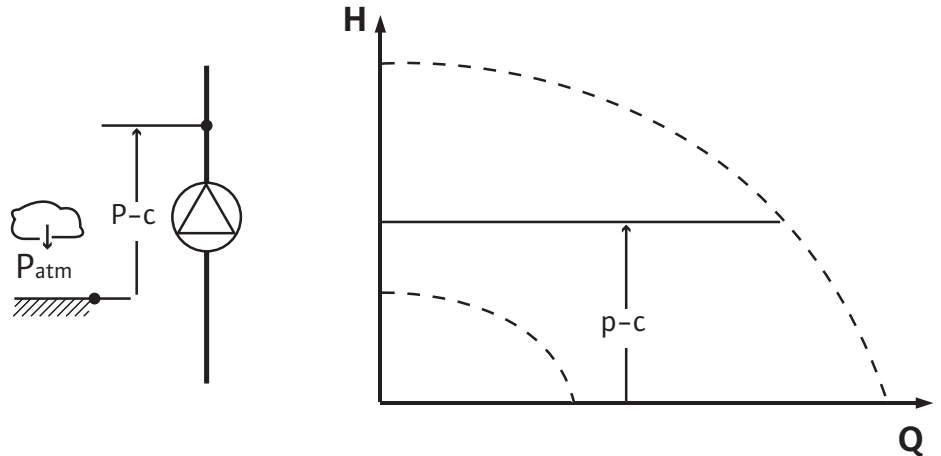

The control keeps a constant pressure at the pump discharge at the selected pressure setpoint  $P_{setpoint}$  whatever the delivery rate required by the installation.

A relative pressure sensor is used for control (sensor: accuracy:  $\leq 1\%$ ; using is the range of 30 % to 100 %).

**Variable pressure p-v**

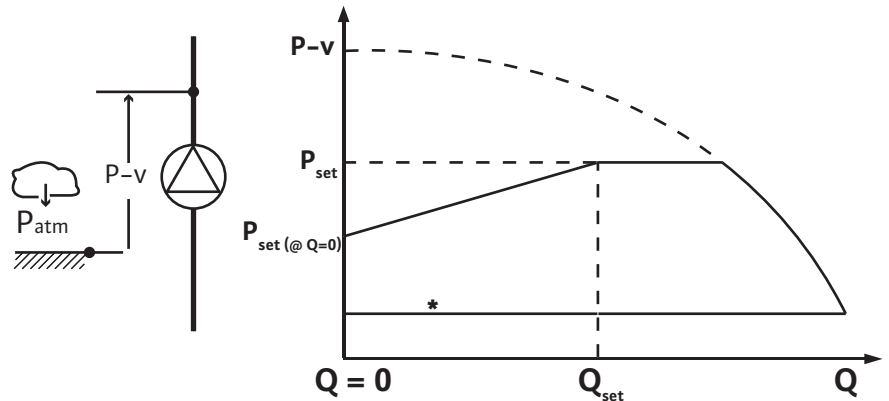

\* Inlet pressure

The control changes the pressure setpoint to be maintained by the pump in linear form between the reduced pressure  $P_{setpoint@Q_0}$  and  $P_{setpoint@Q_{set}}$ .

It is necessary to use a relative pressure sensor on the discharge side and a relative or absolute pressure sensor on the suction side (sensor accuracy:  $\leq 1\%$ ; use a range between 30 % and 100 %).

The controlled pressure falls or increases along with the volume flow. The slope of the p-v characteristic curve can be adjusted to the respective application by setting the  $P_{setpoint@Q_0}$ .

The options for pressure at zero flow " $P_{setpoint@Q_0}$ ", pressure at rated volume flow " $P_{setpoint@Q_{set}}$ " and rated volume flow " $Q_{set}$ " can be found in the Menu [---] of the setpoint editor "p-v setpoint editor".

Optional pressure at zero flow " $P_{setpoint@Q_0}$ " is available.

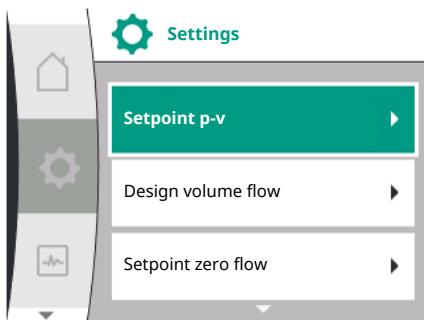

## 9.2 Selecting a control mode

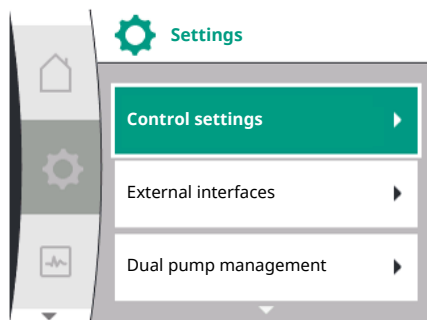

In the "Settings" menu 

1. select "Control settings"
2. Select "Control mode"

Universal	Display text
1.0	Settings
1.1	Control settings
1.2	Monitoring setting
1.3	External interfaces
1.4	Double pump management
1.5	Display settings
1.6	Additional settings

Table 11: "Settings" menu, sub-menus within that



### NOTICE

All parameters must be set for each control mode (except for the factory setting). If a new control mode is set, all parameters must be set again. They are not taken over from the previously set control mode.

Universal	Display text
1.1	Control settings
1.1.1	Control mode
$\Delta p-v$	$\Delta p-v$
$\Delta p-c$	$\Delta p-c$
n-c	n-c
PID control	PID control
p-c	p-c
p-v	p-v

The following basic control modes are available:

Control modes
> Variable differential pressure $\Delta p-v$
> Constant differential pressure $\Delta p-c$
> Constant speed n-c
> PID control
> Constant pressure p-c
> Variable pressure p-v

Table 12: Control modes

The control mode p-c requires a relative pressure sensor to be connected on the pumps discharge side on analog input AI 1 of the pump.

The control mode p-v requires a relative pressure sensor to be connected on the discharge side of the pump to Analog input AI1 of the pump and a relative or absolute pressure sensor to be connected on the suction side of the pump to Analog input AI2 of the pump.

The control modes  $\Delta p-c$  and  $\Delta p-v$  also require the connection of a differential pressure sensor at Analog input AI1.



### NOTICE

With Helix 2.0-VE and Medana CH3-LE pumps the control mode n-c is already pre-configured in the factory.



When a control mode is selected, sub-menus appear. The specific parameters for the respective control mode can be set in these sub-menus.

**9.2.1 Variable differential pressure  $\Delta p-v$  specific parameters**

When the control mode “Variable differential pressure  $\Delta p-v$ ” is selected, the following parameters appear:

Universal	Display text
1.1.1	Control mode
1.1.2 $\Delta p-v$	Setpoint $\Delta p-v$
1.1.7	Emergency operation mode
1.1.8	Emergency operation speed
1.1.9	Setpoint source
1.1.10	Substitute setpoint
1.1.11	No-Flow Stop: ON/OFF
1.1.12	No-Flow Stop: Limit value
1.1.15	Pump ON/OFF

**Setting the setpoint  $\Delta p-v$ .**

When selecting the menu item, the desired delivery head can be set as the setpoint.

Universal	Display text
1.1.2 $\Delta p-v$	Setpoint $\Delta p-v$
H set =	H set =



**NOTICE**

The setpoint can only be set if the setpoint source is set to "Internal setpoint" (see Setting the setpoint source).

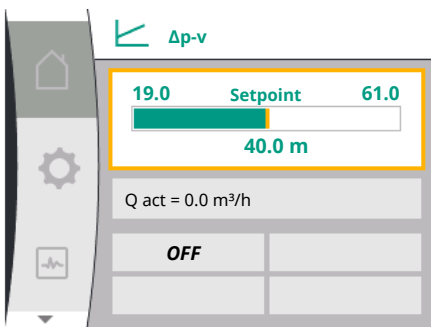

**Setting the emergency operating mode**

In the event of a fault, the failure of the required sensor, an emergency mode can be defined.

When confirming the "Emergency operating mode" menu item, you can choose between pump OFF and pump ON. When selecting Pump ON, another menu item appears: "Emergency operation speed". The emergency speed can be set here.

Universal	Display text
1.1.7	Emergency operation mode
OFF	Pump OFF
ON	Pump ON

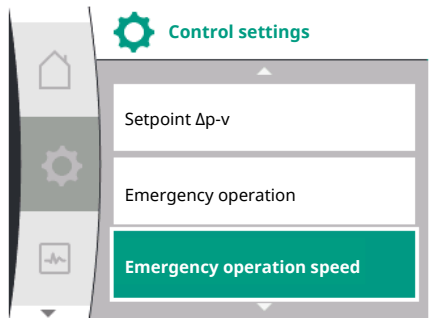
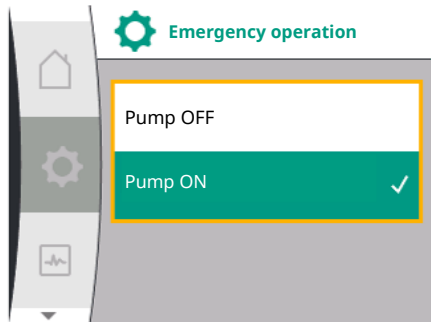

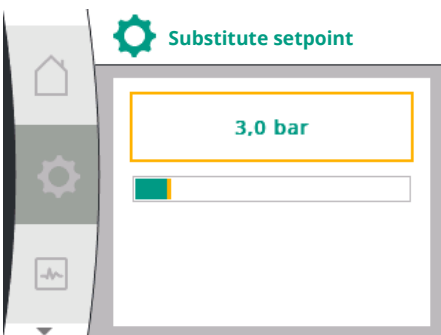
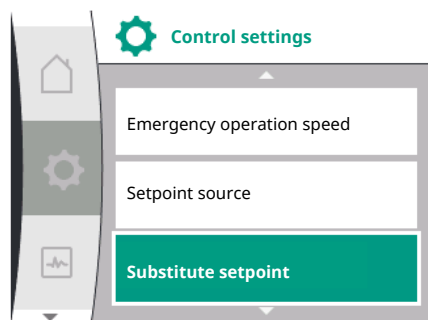
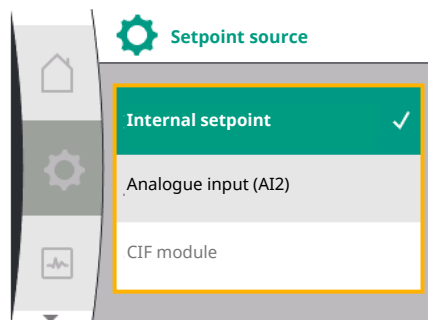
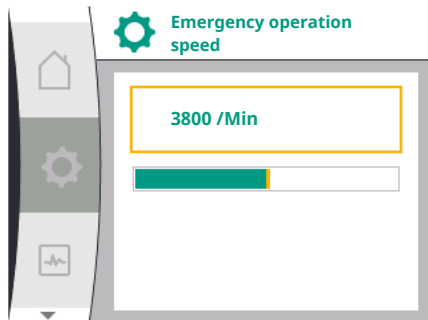

## 9.2.2 Constant differential pressure $\Delta p$ -c specific parameters

Universal	Display text
1.1.8	Emergency operation speed

### Set setpoint source

The setpoint sources can be selected between "Internal setpoint" (setpoint can be set in the display), "Analogue input AI 2" (setpoint from external source) or a "CIF module".

Universal	Display text
1.1.9	Setpoint source
1.1.9 / 1	Internal setpoint
1.1.9 / 2	Analog input (AI2)
1.1.9 / 3	CIF module



### NOTICE

A CIF module can only be selected as a setpoint source if a CIF module is installed. If no CIF module is installed, the menu item cannot be selected (,greyed out'). If the setpoint is selected via the "Analogue input AI 2", the analogue input can be set via the Settings menu.

If an external setpoint source is selected (analogue input or CIF module), the menu item "substitute setpoint" appears. A fixed setpoint can be specified here, which is used for control in the event of a malfunction of the setpoint source (such as a cable break at the analogue input or no communication to the CIF module).

Universal	Display text
1.1.10	Substitute setpoint

### No-Flow Stop: ON/OFF

If no-flow stop is switched ON, an additional setting item for configuration of "No-flow stop limit" appears.

When confirming the " No-flow stop " menu item, you can choose between switch OFF and switch ON. When selecting switch ON, another menu item "No-flow stop limit" appears. The flow limit can be set here.



### NOTICE

If the volume flow decreases due to closing valves and if this falls below limit, the pump is stopped.

The pump checks every 5minutes (300s) whether the volume flow requirement increases again. As soon as this occurs, the pump continues in its set control mode in the control mode.

The time interval to check whether the volume flow has increased compared to the set minimum volume flow "No-Flow Stop limit" is 10s.

When the control mode "differential pressure  $\Delta p$ -c" is selected, the following parameters appear:

Universal	Display text
1.1.1	Control mode

Universal	Display text
<b>1.1.2 <math>\Delta p-c</math></b>	<b>Setpoint <math>\Delta p-c</math></b>
<b>1.1.7</b>	<b>Emergency operation mode</b>
<b>1.1.8</b>	<b>Emergency operation speed</b>
<b>1.1.9</b>	<b>Setpoint source</b>
1.1.9/1	Internal setpoint
1.1.9/2	Analog input (AI2)
1.1.9/3	CIF module
<b>1.1.10</b>	<b>Substitute setpoint</b>
<b>1.1.11</b>	<b>No-Flow Stop: ON/OFF</b>
<b>1.1.12</b>	<b>No-Flow Stop: Limit value</b>
<b>1.1.15</b>	<b>Pump ON/OFF</b>

- Setting the setpoint  $\Delta p-C$   
When selecting the menu item, the desired delivery head can be set as the setpoint.



### NOTICE

The setpoint can only be set if the setpoint source is set to "Internal setpoint" (see Setting the setpoint source).

- Setting the emergency operating mode  
In the event of a fault, the failure of the required sensor, an emergency mode can be defined.  
When the emergency operation mode menu item is confirmed, you can choose between Pump OFF and Pump ON. When selecting Pump ON, another menu item appears: "Emergency operation speed". The emergency speed can be set here.
- Setting the setpoint source  
Sources can be selected between "Internal setpoint", "Analogue input AI 2" or a CIF module.



### NOTICE

A CIF module can only be selected as a setpoint source if a CIF module is installed. If no CIF module is installed, the menu item cannot be selected (,greyed out').

If the setpoint is selected via the "Analogue input AI 2", the analogue input can be set via the Settings menu.

If an external setpoint source is selected (analogue input or CIF module), the menu item "substitute setpoint" appears. A fixed setpoint can be specified here, which is used for control in the event of a malfunction of the setpoint source (such as a cable break at the analogue input or no communication to the CIF module).

- No-Flow Stop: ON/OFF  
If no-flow stop is switched ON, an additional setting item for configuration of "No-flow stop: limit" appears.  
When confirming the " No-flow stop " menu item, you can choose between switch OFF and switch ON. When selecting switch ON, another menu item "No-flow stop limit" appears. The flow limit can be set here.



## NOTICE

If the volume flow decreases due to closing valves and if this falls below limit, the pump is stopped.

The pump checks every 5 minutes (300s) whether the volume flow requirement increases again. As soon as this occurs, the pump continues in its set control mode in the control mode.

The time interval to check whether the volume flow has increased compared to the set minimum volume flow "No-Flow Stop limit" is 10s.

### 9.2.3 Constant speed n-c specific parameters

The following parameters appear when the control mode "n-c" is selected:

Universal	Display text
<b>1.1.1</b>	<b>Control mode</b>
<b>1.1.2 n-c</b>	<b>Setpoint n-c</b>
<b>1.1.9</b>	<b>Setpoint source</b>
1.1.9 / 1	Internal setpoint
1.1.9 / 2	Analog input (AI2)
1.1.9 / 3	CIF module
<b>1.1.10</b>	<b>Substitute setpoint</b>
<b>1.1.15</b>	<b>Pump ON/OFF</b>

- Setting the setpoint n-c  
When the menu item is selected, the desired speed can be set as the setpoint.



## NOTICE

The setpoint can only be set if the setpoint source is set to "Internal setpoint" (see Setting the setpoint source).

- Setting the setpoint source  
Sources can be selected between "Internal setpoint", "Analogue input AI 2" or a CIF module.



## NOTICE

A CIF module can only be selected as a setpoint source if a CIF module is installed. If no CIF module is installed, the menu item cannot be selected (,greyed out').

If the setpoint is selected via the "Analogue input AI 2", the analogue input can be set via the Settings menu.

If an external setpoint source is selected (analogue input or CIF module), the menu item "substitute setpoint" appears. A fixed setpoint can be specified here, which is used for control in the event of a malfunction of the setpoint source (such as a cable break at the analogue input or no communication to the CIF module).

### 9.2.4 PID control specific parameters

The following parameters appear when the control type "PID control" is selected:

Universal	Display text
<b>1.1.1</b>	<b>Control mode</b>
<b>1.1.2 PID</b>	<b>Setpoint PID</b>
<b>1.1.3 Kp</b>	<b>Parameter Kp</b>
<b>1.1.4 Ti</b>	<b>Parameter Ti</b>
<b>1.1.5 Td</b>	<b>Parameter Td</b>
<b>1.1.6</b>	<b>Controller inversion</b>
<b>1.1.7</b>	<b>Emergency operation mode</b>
<b>1.1.8</b>	<b>Emergency operation speed</b>

Universal	Display text
<b>1.1.9</b>	<b>Setpoint source</b>
1.1.9/1	Internal setpoint
1.1.9/2	Analog input (AI2)
1.1.9/3	CIF module
<b>1.1.10</b>	<b>Substitute setpoint</b>
<b>1.1.15</b>	<b>Pump ON/OFF</b>

- Setting the setpoint PID  
When the menu item is selected, the setpoint can be set.



### NOTICE

The setpoint can only be set if the setpoint source is set to “Internal setpoint” (see “Setting the setpoint source”).

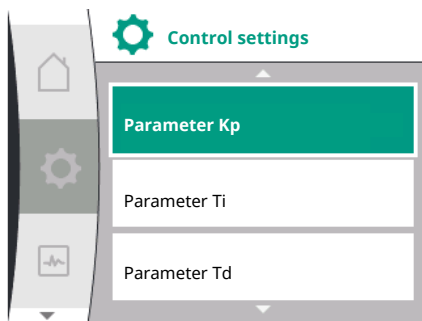

- Setting the parameter Kp  
When selecting the menu item, the desired Kp can be set.
- Setting the parameter Ti  
When selecting the menu item, the desired Ti can be set.
- Setting the parameter Td  
When selecting the menu item, the desired Ti can be set.
- Setting the Controller Inversion  
When selecting the menu item, it's possible to choose PID control mode with “inversion OFF” or “inversion ON”
- Setting the emergency operating mode  
In the event of a fault, the failure of the required sensor, an emergency mode can be defined.  
When the emergency operation mode menu item is confirmed, you can choose between Pump OFF and Pump ON. When selecting Pump ON, another menu item appears: “Emergency operation speed”. The emergency speed can be set here.
- Setting the setpoint source  
Sources can be selected between “Internal setpoint”, “Analogue input AI 2” or a CIF module.



### NOTICE

A CIF module can only be selected as a setpoint source if a CIF module is installed. If no CIF module is installed, the menu item cannot be selected (,greyed out').

If the setpoint is selected via the "Analogue input AI 2", the analogue input can be set via the Settings menu.

If an external setpoint source is selected (analogue input or CIF module), the menu item "substitute setpoint" appears. A fixed setpoint can be specified here, which is used for control in the event of a malfunction of the setpoint source (such as a cable break at the analogue input or no communication to the CIF module).

## 9.2.5 Constant pressure p-c specific parameter

With selection of the control mode ,Constant pressure p-c the following parameters are adjustable:

Universal	Display text
<b>1.1.1</b>	<b>Control mode</b>
<b>1.1.2 p-c</b>	<b>Setpoint p-c</b>
<b>1.1.3 Kp</b>	<b>Parameter Kp</b>
<b>1.1.4 Ti</b>	<b>Parameter Ti</b>
<b>1.1.7</b>	<b>Emergency operation mode</b>

Universal	Display text
<b>1.1.8</b>	<b>Emergency operation speed</b>
<b>1.1.9</b>	<b>Setpoint source</b>
1.1.9 / 1	Internal setpoint
1.1.9 / 2	Analog input (AI2)
1.1.9 / 3	CIF module
<b>1.1.10</b>	<b>Substitute setpoint</b>
<b>1.1.13</b>	<b>Zero flow</b>
1.1.13/1	Zero flow test: ON/OFF
1.1.13/2	Zero flow due to overpressure: ON/OFF
1.1.13/3	Zero flow due to overpressure: Pump switch-off limit value
1.1.13/4	Zero flow: Pump switch-off delay
1.1.13/5	Zero flow: Pump restart limit value
<b>1.1.15</b>	<b>Pump ON/OFF</b>

The following parameters appear when the control mode “p-c” is selected.

#### Setting the setpoint p-c

When selecting the menu item, the desired pressure can be set as the setpoint.



#### NOTICE

The setpoint is only adjustable, when the Setpoint source is configured as „Internal setpoint“ (see Configuration of Setpoint source).

#### Setting the parameter Kp

When selecting the menu item, the desired Kp can be set.



#### NOTICE

This factory setting parameter is suitable for most of the water supply applications. This parameter can be adjusted by an expert in order to correct pressure instabilities in the installation.

#### Setting the parameter Ti

When selecting the menu item, the desired Ti can be set.



#### NOTICE

This factory setting parameter is suitable for most of the water supply applications. This parameter can be adjusted by an expert in order to correct pressure instabilities in the installation.

#### Setting the emergency operating mode

In the event of a fault, if the required sensor malfunctions, an emergency operation mode can be defined.

When the emergency operation mode menu item is confirmed, you can choose between Pump OFF and Pump ON. When selecting Pump ON, another menu item appears: “Emergency operation speed”. The emergency speed can be set here.

#### Setting the setpoint source

Sources can be selected between “Internal setpoint”, “Analogue input AI 2” or a CIF module.



## NOTICE

A CIF module can only be selected as a setpoint source if a CIF module is installed. If no CIF module is installed, the menu item cannot be selected (,greyed out'). If the setpoint is selected via the "Analogue input AI 2", the analogue input can be set via the Settings menu.

If an external setpoint source is selected (analogue input or CIF module), the menu item "substitute setpoint" appears. A fixed setpoint can be specified here, which is used for control in the event of a malfunction of the setpoint source (such as a cable break at the analogue input or no communication to the CIF module).

### Zero flow

- Zero flow test: ON/OFF

When confirming the " Zero flow test " menu item, you can choose between switch OFF and switch ON.

When selecting Pump ON, another menu item "Zero flow: pump stop delay" appears. The delay time before stopping and the pressure limit value for restarting the pump can be set here.



## NOTICE

The "zero-flow test" control function stops the pump when there is no flow demand and restarts when flow is demanded again. This saves electricity and reduces wear.

A zero-flow test is performed cyclically by briefly decreasing the pressure setpoint. In some cases, the pressure setpoint is at first increased and then decreased back to the prior pressure setpoint.

If the discharge pressure drops according to the decreased constant pressure setpoint, there is flow demand and the pump continues operation.

If the discharge pressure does not drop according to the decreased pressure setpoint, there is no flow demand in the water supply system.

If necessary, the pump increases the end pressure again to charge the membrane tank. This results in better user comfort.

After the set "Switch-off delay" has elapsed, the pump is stopped.

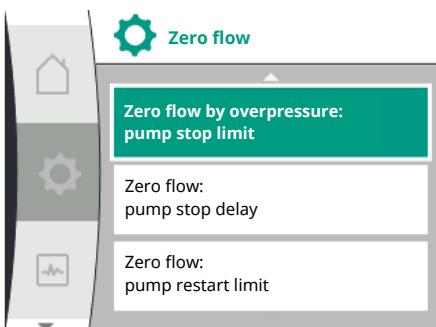
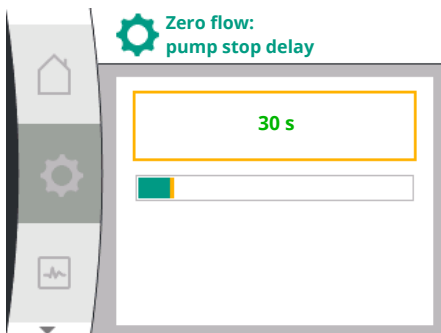
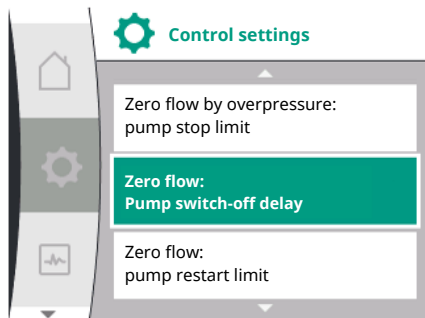
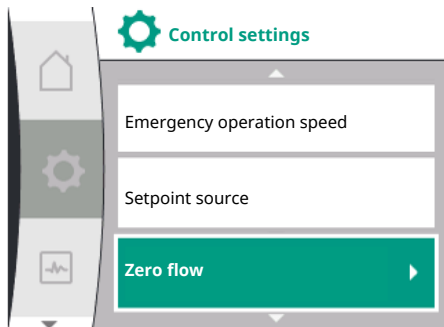

- Zero flow due to overpressure: ON/OFF.

After confirming the "Zero flow due to overpressure" menu item, there is a choice of switching on and switching off.

If "ON" is selected, the following menu items appear:

- "Zero flow by overpressure: pump stop limit"
- "Zero flow: pump stop delay"
- "Zero flow: pump restart limit"

It is possible here to set the pressure threshold for stopping the pump, the delay time before the pump stops and the pressure threshold for restarting the pump.

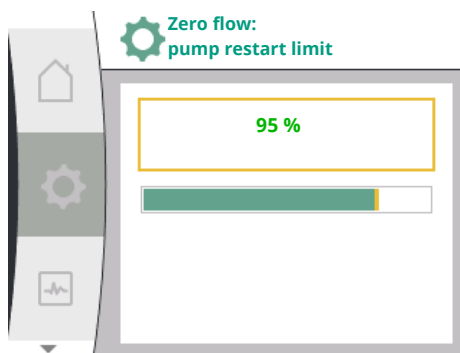
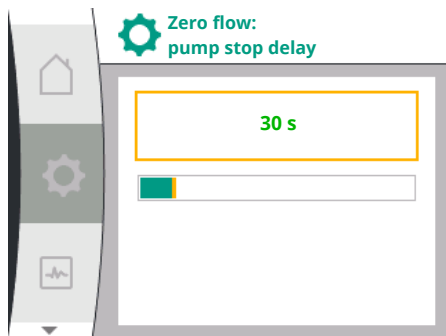
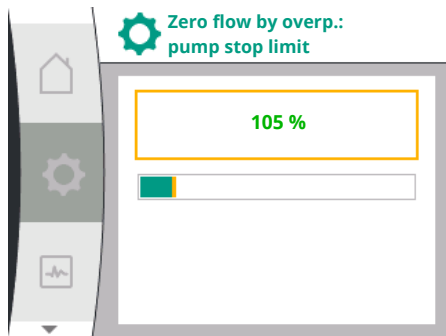

### 9.3 Switch off the pump

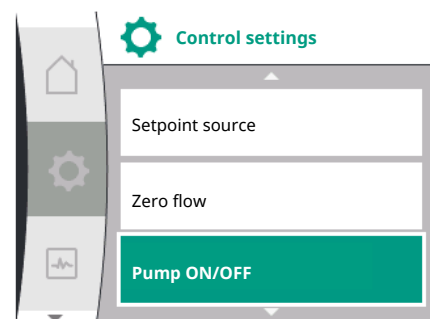

## NOTICE

The “zero flow due to overpressure” function stops the pump if the delivery pressure is greater than the adjustable pressure threshold, and will restart it again when flow is demanded. This function is useful since it avoids stress being placed on the installation as a result of unnecessarily high pressures and is also useful for applications involving a large diaphragm expansion tank.

The menu item “Zero flow due to overpressure: pump stop limit” is used to set the pressure threshold for deactivation. Should this pressure threshold be exceeded, the pump will switch off after the elapse of the period of time that has been set in the “Zero flow: pump stop delay” menu item.

The menu item “Zero flow: pump restart limit” is used to set the pressure threshold for restarting the pump. If the pressure falls below the limit value, the pump is restarted.

The “Zero-flow test” function (see above) changes the pressure used in the test procedure on a cyclical basis. In order to avoid any interactions with the “Zero-flow test” function, the “Zero-flow due to overpressure” function is changed temporarily during pressure change phases. This allows the pressure values to slightly exceed the configured pressure thresholds.

In the “Settings” menu  select:

1. Control settings
2. “Pump ON/OFF”

The pump can be switched on/off.

Universal	Display text
<b>1.1.15</b>	<b>Pump ON/OFF</b>
OFF	Switched OFF
ON	Switched ON



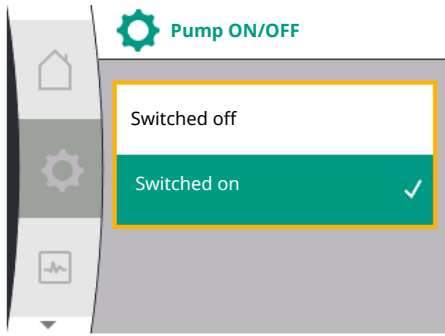

It is possible to switch off the pump by the manual function "Pump ON/OFF".

This stops the motor and interrupts normal operation with the set control function. The pump must be switched on again via pump ON in order that the pump can continue to run in the set control mode.



**WARNING**

The "Pump OFF" connection only overrules the set control function and only stops the motor. This means that the pumps are not electrically isolated. For maintenance activities, the pump must be electrically isolated.

**9.4 Configuration storage/data storage**

The control module is equipped with a non-fading memory for saving the configuration. All settings and data are retained no matter how longer the module is disconnected from the power supply.

If the voltage is present again, the pump runs using the default settings that were available before interruption.

**10 Monitoring functions**

Overview of the terms in the display for selecting the monitoring settings in the available languages:

Universal	Display text
<b>1.2</b>	<b>Monitoring settings</b>
<b>1.2.1</b>	<b>Min. pressure detection</b>
1.2.1.1	Min. pressure detection: ON/OFF
1.2.1.2	Min. pressure detection: Limit value
1.2.1.3	Min. pressure detection: Delay
<b>1.2.2</b>	<b>Max. pressure detection</b>
1.2.2.1	Max. pressure detection: ON/OFF
1.2.2.2	Max. pressure detection: Limit value
1.2.2.3	Max. pressure detection: Delay
<b>1.2.3</b>	<b>Lack of water detection</b>
1.2.3.1	Lack of water detection by sensor: ON/OFF
1.2.3.2	Lack of water detection by sensor: Limit value
1.2.3.3	Lack of water detection by switch: ON/OFF
1.2.3.4	Lack of water detection: Pump switch-off delay
1.2.3.5	Lack of water detection: Pump activation delay

Additional to the control functions some functions for monitoring the system, dependent on the selected control mode, are available in the Menu Settings

1. Monitoring settings

The optional monitoring functions are:

Universal	Display text
<b>1.2</b>	<b>Monitoring settings</b>
<b>1.2.1</b>	<b>Min. pressure detection</b>
<b>1.2.2</b>	<b>Max. pressure detection</b>
<b>1.2.3</b>	<b>Lack of water detection</b>

- Min. pressure detection
- Max. pressure detection
- Lack of water detection

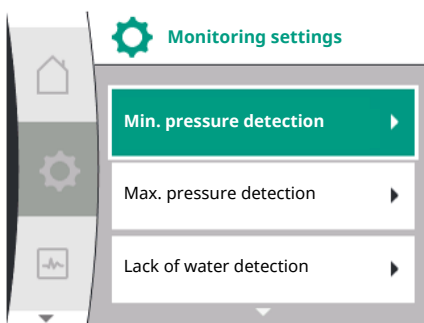

## 10.1 Min. pressure detection

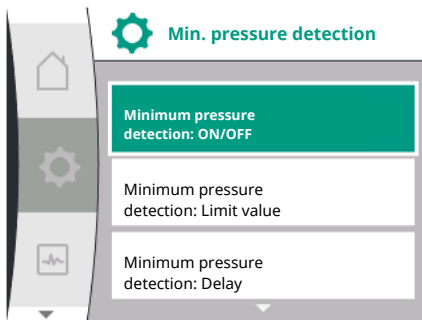
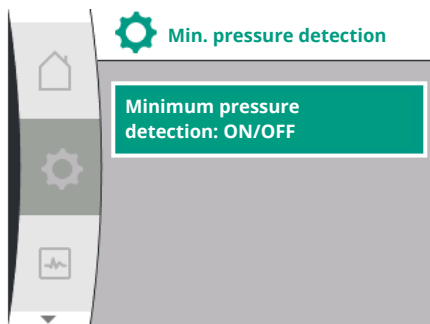

## 10.2 Max. pressure detection



### NOTICE

An optional monitoring function that was switched ON, will be set back to OFF when a new control mode is selected.

Every setting is stored and will be reloaded after a power cycle.

The minimum pressure limit detection function detects an undershooting of a minimum pressure limit. This function is mainly a pipe-burst-detection (detection of big leakage or broken pipe on discharge side).

If the pressure on discharge side is falling below a user configurable pressure for a user configurable time the motor will stop and an error is raised. When the pressure is above the limit the pump will restart again immediately. The defined time is preventing the pump from frequently starts and stops.



### NOTICE

The menu item "Min. Pressure detection" is only available for the control modes p-c and n-const.

In menu Setting

Universal	Displaytext
<b>1.2.1</b>	<b>Min. pressure detection</b>
1.2.1.1	Min. pressure detection: ON/OFF
1.2.1.2	Min. pressure detection: Limit value
1.2.1.3	Min. pressure detection: Delay

- Monitoring settings
- Min. pressure detection

The function can be switched ON and OFF

If the function is switched ON, the following additional settings appear in the Menu:

Min. pressure detection: Limit value

-> The pressure limit used as detection threshold.

Min. pressure detection: Delay

->The time the pressure undershot is existing before the error is raised and the motor is stopped. The delay time is configured in seconds.



### NOTICE

The input value of the actual duty point for "Min. pressure limit" shall be delivered by an external relative pressure sensor connected on pumps discharge side. The relative pressure sensor has to be connected to the terminals AI 1. The AI 1 analog input must be configured accordingly.

The maximum pressure limit detection function detects overshooting of pressure. The function is essential for protection of customer installation to avoid over pressure on the discharge side. If the pressure exceeds an user configurable threshold for 5s, the motor will stop and an error is raised. When the pressure is below the threshold for an user configurable time the motor will restart again. The error will be indicated on the HMI.



### NOTICE

The menu item "Max. Pressure detection" is only available for the control modes p-c and n-const.

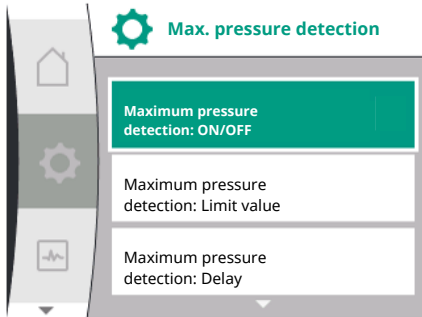
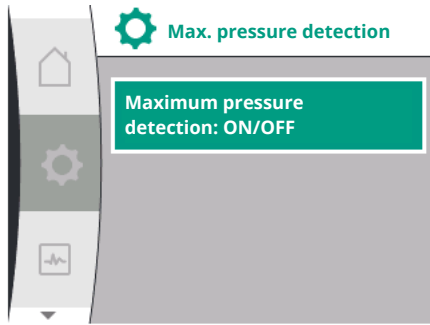

In menu Setting

Universal	Displaytext
<b>1.2.2</b>	<b>Max. pressure detection</b>
1.2.2.1	Max. pressure detection: ON/OFF
1.2.2.2	Max. pressure detection: Limit value
1.2.2.3	Max. pressure detection: Delay

1. Monitoring settings
2. Max. pressure detection

The function can be switched ON and OFF

If the function is switched ON, the following additional settings appear in the Menu:

Max. pressure detection: Limit value

-> The pressure limit used as detection threshold.

Max. pressure detection: Delay

->The time the motor will stop before the motor restart again. The delay time is configured in seconds.



### NOTICE

The input value of the actual duty point for "Max. pressure limit" shall be delivered by an external relative pressure sensor connected on pumps discharge side. The relative pressure sensor has to be connected to the terminals AI 1. The AI 1 analog input must be configured accordingly.

## 10.3 Lack of water detection

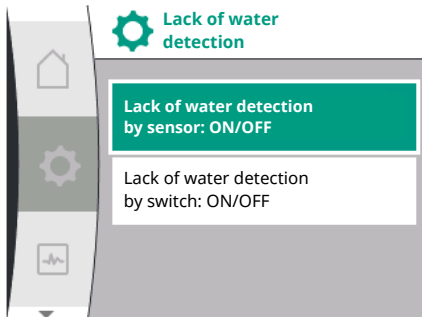

There are two ways of lack of water detection: Via the analog input (usually by suction pressure sensor) and/or via a digital input (usually level switch). The selection and configuration of the method is done in

Menu Setting

Universal	Displaytext
<b>1.2.3</b>	<b>Lack of water detection</b>
1.2.3.1	Lack of water detection by sensor: ON/OFF
1.2.3.2	Lack of water detection by sensor: Limit value
1.2.3.3	Lack of water detection by switch: ON/OFF
1.2.3.4	Lack of water detection: Pump switch-off delay
1.2.3.5	Lack of water detection: Pump activation delay

1. Monitoring settings
2. Lack of water detection

### 10.3.1 Lack of water detection by suction pressure sensor

When the pump is directly connected to the supplier system, there is the risk of too low pressure at the suction side. The function "lack of water detection by pressure sensor" protects the pump and the supplier system from this low pressure. If the pressure at suction side falls below an user configurable threshold for a user configurable time interval, the motor will stop. A user configurable time interval before the pump starts ensures that the detection is not toggling. If the motor is stopped via the function an error will be indicated on the HMI.



### NOTICE

The menu item "Lack of water detection" is only available for the control modes p-c, p-v, PID and n-const.

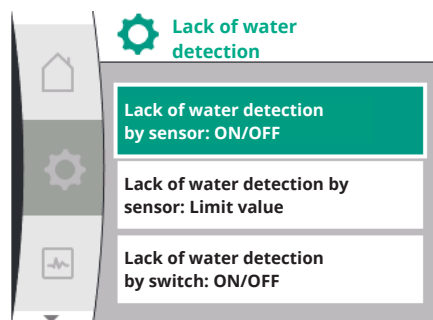
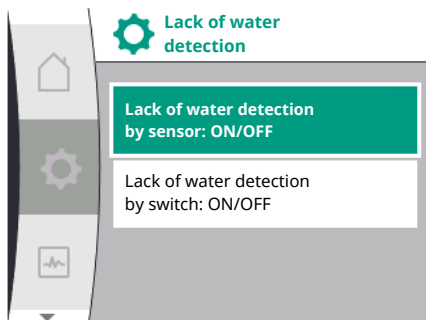

### 10.3.2 Lack of water detection by binary input

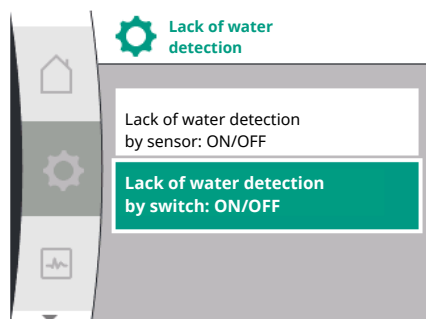

In menu Setting

Universal	Displaytext
<b>1.2.3</b>	<b>Lack of water detection</b>
1.2.3.1	Lack of water detection by sensor: ON/OFF
1.2.3.2	Lack of water detection by sensor: Limit value
1.2.3.4	Lack of water detection: Pump switch-off delay
1.2.3.5	Lack of water detection: Pump activation delay

1. Monitoring settings
2. Lack of water detection
3. Lack of water detection by sensor: ON/OFF

The function can be switched ON and OFF

If the function is switched ON, the following additional settings appear in the Menu:

Lack of water detection by sensor: Limit value

-> The pressure limit used as detection threshold.

Lack of water detection: Pump switch-off delay

-> The delay time is configured in seconds.

Lack of water detection: Pump activation delay

-> The delay time is configured in seconds.



#### NOTICE

The function requires an external relative or absolute pressure sensor connected on pumps suction side. The pressure sensor has to be connected to the terminals AI 2. The AI 2 analog input must be configured accordingly.

The function lack of water detection by switch is usually used with a break tank and a mechanical level switch (seldom with a pressure switch). With low water level in the break tank the level switch opens a wire circuit. The pump detects this opening by circuit connection to the digital binary input.

The motor is switched off while the binary input is opened for a user configurable time intervall. If the binary input is closed for a user configurable time intervall, the motor will start. If the pump is stopped via the function an error will be indicated on the HMI.



#### NOTICE

The menu item "Lack of water detection" is only available for the control modes p-c, p-v, PID and n-const.

In menu Setting

Universal	Displaytext
<b>1.2.3</b>	<b>Lack of water detection</b>
1.2.3.3	Lack of water detection by switch: ON/OFF
1.2.3.4	Lack of water detection: Pump switch-off delay
1.2.3.5	Lack of water detection: Pump activation delay

1. Monitoring settings
2. Lack of water detection
3. Lack of water detection by switch: ON/OFF

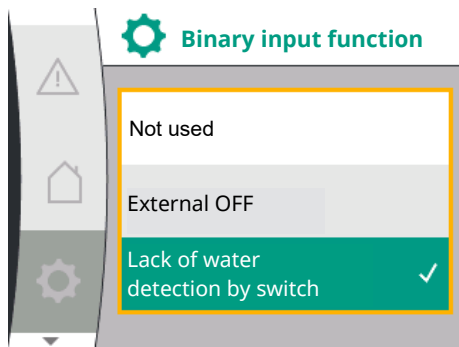
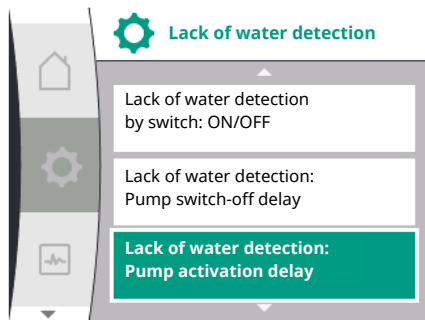

The function can be switched ON and OFF

If the function is switched ON, the following additional settings appear in the Menu:

Lack of water detection: Pump switch-off delay

-> The delay time is configured in seconds.

Lack of water detection: Pump activation delay

-> The delay time is configured in seconds.

In order to activate the system, the binary input function

“Lack of water detection by switch” must be enabled in Menu  “Settings”.

Universal	Displaytext
<b>1.3</b>	<b>External interfaces</b>
<b>1.3.2</b>	<b>Binary input</b>
1.3.2.1	Binary input function
1.3.2.1/3	Lack of water detection by switch

1. External interface
2. Binary input
3. Binary input function
4. Lack of water detection by switch

See also Chapter 13.3 "Application and function of the digital control input DI 1"



## NOTICE

The binary input usage will be automatically configured to "unused" when the function "Lack of water detection by switch" is switched off.

## 11 Double pump operation

Overview of the terms in the display for selecting the double pump management in the available languages:

Universal	Display text
<b>1.4</b>	<b>Double pump management</b>
<b>1.4.1</b>	<b>Connect double pump</b>
1.4.1.1	Double pump partner address
1.4.1.2	Establish double pump pairing
<b>1.4.2</b>	<b>Disconnect double pump</b>
<b>1.4.3</b>	<b>Double pump function</b>
1.4.3.1	Duty/Standby
<b>1.4.4</b>	<b>Pump cycling</b>
1.4.4.1	Time-based pump cycling: ON/OFF
1.4.4.2	Time-based pump cycling: Interval
1.4.4.3	Manual pump cycling

### 11.1 Function

All Helix2.0 VE and Medana CH3-LE are equipped with an integrated double pump management.

In the "double pump management", a connection can be established or disconnected. The dual pump management has the following functions:

#### Main/standby operation:

Each of the two pumps provides the configured flow rate. The other pump is available in case of malfunction or runs after pump cycling. Only one pump runs at a time (factory setting).

#### Pump cycling

The actively operated pump is regularly changed automatically to guarantee even usage of both pumps in the event of single pump operation. If only one pump is running, the pump being operated alternates after 24h effective running time at the latest. Both pumps run at the time of pump changeover so that operation is not interrupted. The operated pump can be replaced at least every 1 hour and can be set in length increments up to a maximum of 36 hours.



## NOTICE

Even after the mains voltage has been switched off and switched on again, the remaining time until the next pump cycling continues to run. The timer does not start again from the beginning!

### SSM/ESM (collective fault signal/individual fault signal)

- The **SSM function** must preferably be connected to the main pump. The SSM contact can be configured as follows:  
the contact reacts either only in the event of a fault or in the event of a fault and a warning.

**Factory setting:** SSM responds only in the event of an error. Alternatively or additionally, the SSM function can also be activated on the standby pump. Both contacts work in parallel.

- **ESM:** The ESM function of the double pump can be configured on each head of the double pump head as follows: The ESM function on the SSM contact only signals faults of the respective pump (individual fault signal). In order to record all faults of the two pumps, both contacts must be assigned.

### SBM/EBM (collective run signal/individual run signal)

- The **SBM contact** can be assigned to any of the two pumps. The following configuration is possible:

The contact is activated when the motor is in operation, power supply is present or no fault is present.

**Factory setting:** ready for operation. Both contacts signal the operating status of the double pump in parallel (collective run signal).

- **EBM:** The EBM function of the double pump can be configured as follows: The SBM contacts only signal run signals of the respective pump (individual run signal). In order to record run signals of both the pumps, both contacts must be assigned.

### Communication between pumps:

When connecting two similar single pumps to do a double pump, Wilo Net must be installed between the pumps using a cable.

Then set the termination and the Wilo Net address in the menu under "Settings/External interfaces/Settings Wilo Net". Then, in the "Dual pump management" sub-menu of the "Settings" menu, select the settings "Connect double pump".



## NOTICE

For the installation of two single pumps to form a double pump, see chapter "Double pump installation", "Electrical connection" and "Application and function of the Wilo Net interface".

The control of both pumps starts from the main pump to which the differential pressure sensor is connected.

In case of breakdown/fault/communication interruption, the main pump alone takes over complete operation. The main pump runs as a single pump according to the set operating modes of the double pump.

The standby pump, which receives no data from the differential pressure sensor, runs in the following cases at an adjustable constant emergency operation speed.

- The main pump to which the differential pressure sensor is connected fails.

## 11.2 Settings menu

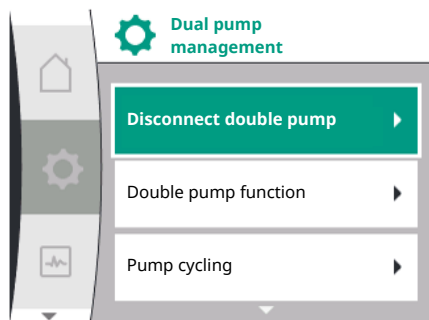
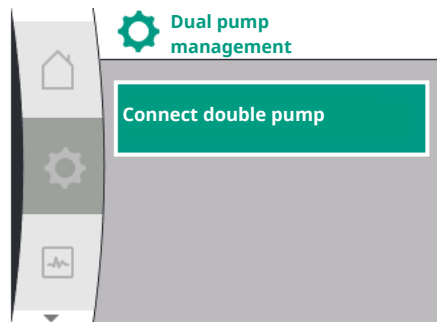
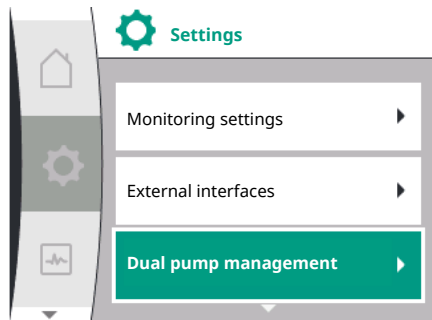

- The communication between the main pump and the standby pump is interrupted. The standby pump starts immediately after detecting a fault.

In the “Double pump management” menu, a double pump connection can be established or disconnected and also the double pump function can be adjusted.

### The menu Settings



Double pump management

has different sub-menus depending on the status of the double pump connection. If a double pump connection is present, the following setting is possible:

Universal	Display text
<b>1.4</b>	<b>Double pump management</b>
<b>1.4.1</b>	<b>Connect double pump</b>
1.4.1.1	Double pump partner address
1.4.1.2	Establish double pump pairing
<b>1.4.2</b>	<b>Disconnect double pump</b>
<b>1.4.3</b>	<b>Double pump function</b>
1.4.3.1	Duty/Standby
<b>1.4.4</b>	<b>Pump cycling</b>
1.4.4.1	Time-based pump cycling: ON/OFF
1.4.4.2	Time-based pump cycling: Interval
1.4.4.3	Manual pump cycling

- Connecting double pump

The following settings are possible with no existing double pump connection:

- Disconnect double pump
- Double pump function
- Pump cycling

### Menu “Connecting double pump”

If double pump connection is not yet established, in the “Settings” menu , select

Universal	Display text
<b>1.4</b>	<b>Double pump management</b>
<b>1.4.1</b>	<b>Connect double pump</b>
1.4.1.1	Double pump partner address
1.4.1.2	Establish double pump pairing

1. “Double pump management”
2. “Connecting double pump”

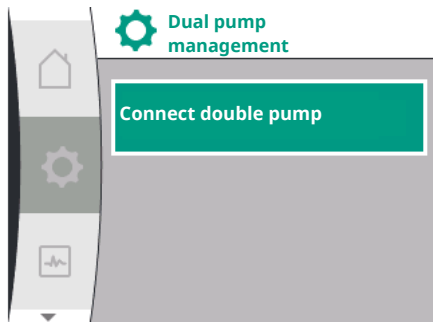

After selecting the menu item "Connect double pump", the Wilo Net address of the double pump partner must first be set on both pumps to be paired to a double pump, e.g.: pump I has the Wilo Net address 1, pump II has the Wilo Net address 2: Then address 2 must be set in pump I and address 1 for pump II.

After configuring the partner addresses, the double pump connection can be started or cancelled by confirming via the menu item "double pumps pairing".



### NOTICE

The pump from which the double pump pairing is started is the main pump. The main pump is to be the pump to which the pressure sensor is connected.

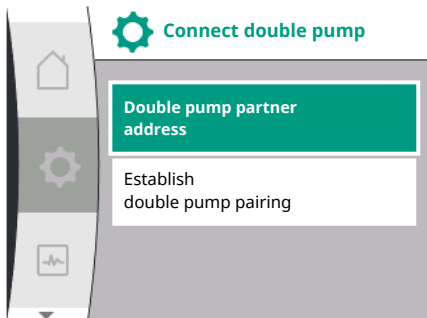

After configuring the partner addresses, the double pump connection can be started or cancelled by confirming via the menu item "Double pump pairing status".

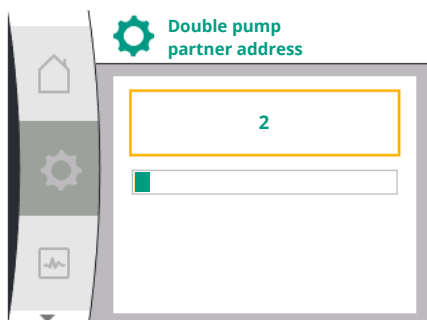

Double pump connection successful

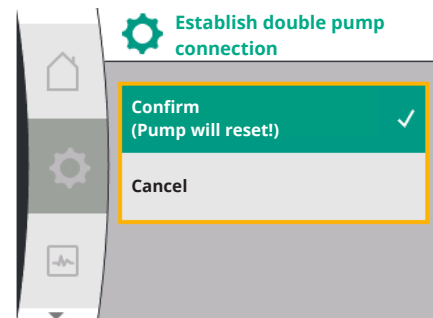

### NOTICE

Different parameters of the pump are fundamentally changed when creating the double pump function. The pump is then started automatically.

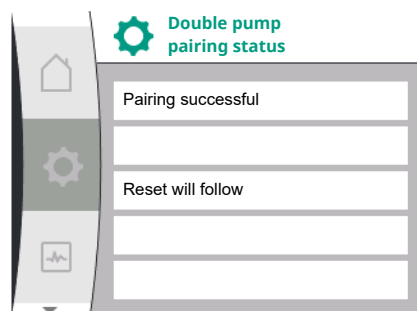

Double pump connection failed

- Partner not found
- Partner already paired
- Partner incompatible



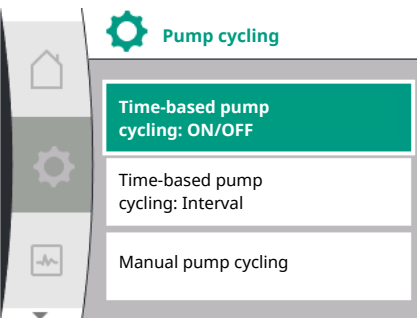
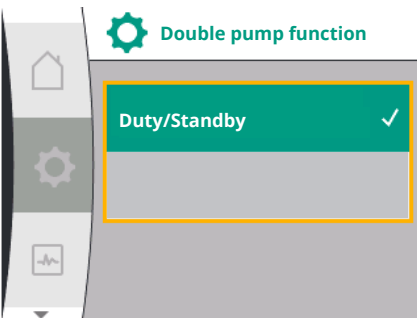
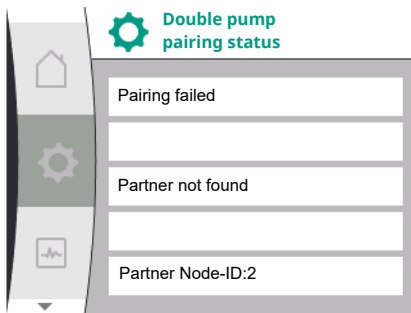

### 11.3 Display in double pump operation



#### NOTICE

In the event of a double pump connection failure, the partner address must be reconfigured. Please check the correctness beforehand.

#### Menu "Double pump function"

When a double pump connection is established, the "double pump function" menu is used to Duty/standby operation.

Universal	Display text
1.4	Double pump management
1.4.3	Double pump function
1.4.3.1	Duty/Standby



#### NOTICE

When switching the double pump function, different parameters of the pump are fundamentally changed. The pump is then started automatically. After the restart, the pump is returned to the main menu.

#### Menu "Pump cycling interval"

If a double pump connection is established, the function can be activated or deactivated in the menu "Pump cycling" and the time interval can be set. Time interval: between 1 hour and 36 hours, factory setting: 24 h

Universal	Display text
1.4	Double pump management
1.4.4	Pump cycling
1.4.4.1	Time-based pump cycling: ON/OFF
1.4.4.2	Time-based pump cycling: Interval
1.4.4.3	Manual pump cycling

An immediate pump cycling can be triggered via the menu item "manual pump cycling". The manual pump cycling can always be performed regardless of the configuration of the time-based pump cycling function.

#### Menu "Disconnect double pump"

When a double pump function is established, it can also be separated. Select "Disconnect double pump" in the menu.

Universal	Display text
1.4	Double pump management
1.4.2	Disconnect double pump



#### NOTICE

When separating double pump function, different parameters of the pump are fundamentally changed. The pump is then started automatically.

Each double pump partner has its own graphical display showing the values and settings. On the display of the main pump with a pressure sensor mounted, the home screen is visible as for a single pump. The SL feature is shown in the setpoint display field on the display of the partner pump without the pressure sensor installed.

When a double pump connection is established, entries on the graphic display of the pump partner are not possible. This is represented by a lock symbol on the main menu symbol.

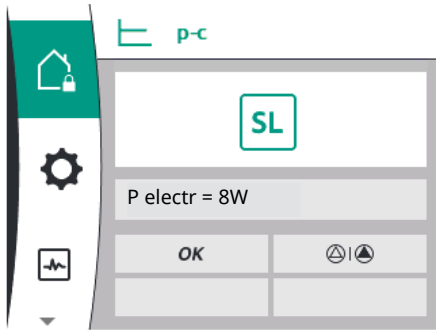

### Symbol of main and partner pump

The home screen shows which pump is the main pump and which is the partner pump.

- Main pump with pressure sensor mounted: Home screen as for single pump.
- Partner pump without pressure sensor mounted: SL symbol in the setpoint display field.

In the "Active influences" area, two pump symbols are shown in double pump operation.

They have the following meaning:

#### Case 1 – Main/standby operation: Only main pump is running

Appears in the main pump's display	Appears in the partner pump's display
▲ △	△ ▲

#### Case 2 – Main/standby operation: Only partner pump is running

Appears in the main pump's display	Appears in the partner pump's display
△ ▲	▲ △

## 12 Communication interfaces: Setting and function

Select the following in the "Settings" menu :

Universal	Display text
1.0	Settings
1.3	External interfaces

Possible selection of external interfaces:

Universal	Display text
1.3.1	SSM relay
1.3.2	Control input
1.3.3	Analog input (AI1)
1.3.4	Analog input (AI2)
1.3.5	Wilo Net settings
1.3.6	SBM relay



### NOTICE

The submenus for setting the analogue inputs are only available depending on the selected control mode.

### 12.1 Menu overview of "External interfaces"

Universal	Display text
1.0	Settings
1.3	External interfaces
1.3.1	SSM relay
1.3.2	Control input
1.3.3	Analogue input (AI1)
1.3.4	Analogue input (AI2)
1.3.5	Wilo Net settings
1.3.6	SBM relay

### 12.2 SSM application and function

The contact of the collective fault signal (SSM, potential-free changeover contact) can be connected to a building automation system. The SSM relay can either switch on only in case of fault or for faults and warnings. The SSM relay can be used as a normally closed contact or a normally open contact.

- When the pump is without power, the NC contact is closed.

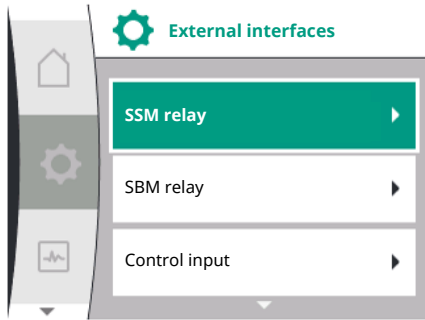

Fig. 28: External interfaces menu

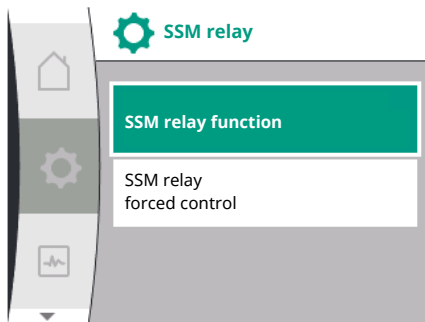

Fig. 29: Menu SSM-relay

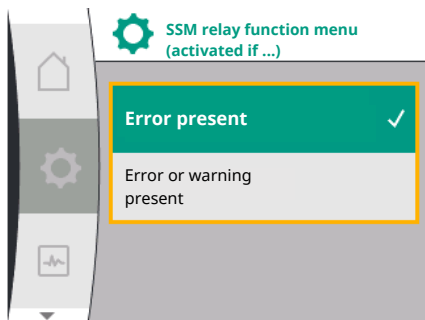

Fig. 30: SSM relay function menu

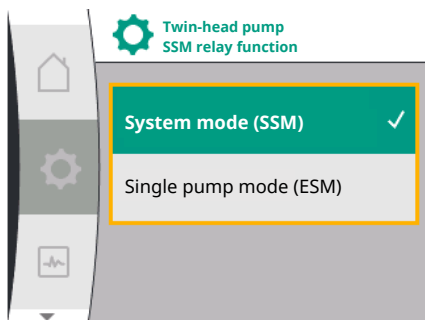

Fig. 31: Twin-head pump SSM relay function menu

- If there is a fault, the contact at NC is open. The converter bridge to NO is closed.

To do this, select the following in the menu:

Universal	Display text
1.0	Settings
1.3	External interfaces
1.3.1	SSM relay
1.3.1.2	SSM relay function <sup>1</sup>
1.3.1.2 / 1	Error present
1.3.1.2 / 2	Error or warning present
1.3.1.2 / 3	Error present at twin-head pump head

<sup>1</sup>Only appears if twin-head pump is configured.

Possible settings:

Selection option	Function SSM relay
Only fault (factory setting)	SSM relay connects only in case of fault. Fault means: The pump is not running.
Faults and warnings	SSM relay connects only in case of fault or a warning.

Table 13: Function SSM relay

### SSM/ESM (collective fault signal/individual fault signal) in twin-head pump operation

- **SSM:** The SSM function must preferably be connected to the main pump. The SSM contact can be configured as follows: the contact reacts either only in the event of a fault or in the event of a fault and a warning. Factory setting: SSM only reacts in the event of a fault. Alternatively or additionally, the SSM function can also be activated on the standby pump. Both contacts work in parallel.
- **ESM:** The ESM function of the twin-head pump can be configured on each twin-head pump head as follows: The ESM function on the SSM contact only signals faults of the respective pump (individual fault signal). In order to detect all faults of the two pumps, the contacts must be assigned in both drives.

Universal	Display text
1.0	Settings
1.3	External interfaces
1.3.1	SSM relay
1.3.1.4 <sup>2</sup>	Twin-head pump SSM relay function <sup>2</sup>

### 12.3 SSM relay forced control

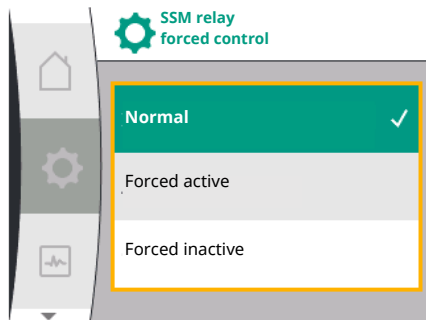

Fig. 32: SSM relay forced control

Universal	Display text
SSM	System mode (SSM)
ESM	Single pump mode (ESM)

<sup>2</sup> These sub-menus only appear when the twin-head pump is connected.

An SSM/SBM relay forced control is used as function test of the SSM relay and electrical connections.

To do this, select the following in the menu:

Universal	Display text
1.0	Settings
1.3	External interfaces
1.3.1	SSM relay
1.3.1.6	SSM relay forced control
1.3.1.6 / 1	Normal
1.3.1.6 / 2	Forced active
1.3.1.6 / 3	Forced inactive

Selection options:

SSM relay forced control	Help text
Normal	<b>SSM:</b> Depending on the SSM configuration, fault and warnings influence the SSM relay switching status.
Forced active	SSM relay switching status is forced ACTIVE. <b>CAUTION:</b> <b>SSM does not display the pump status!</b>
Forced inactive	SSM/SBM relay switching status is forced INACTIVE. <b>CAUTION:</b> <b>SSM does not display the pump status!</b>

Table 14: Selection option SSM relay forced control

The “Forced active” setting permanently activates the relay. This means that, for example, a warning note (light) is permanently displayed/announced.

The “Forced inactive” setting leaves the relay permanently without a signal. No warning note can be confirmed.

### 12.4 SBM application and function

The contact of the collective run signal (SBM, potential-free changeover contact) can be connected to a building automation system. The SBM contact signals the operating status of the pump.

- The SBM contact can be assigned to any of the two pumps. The following configuration is possible:

The contact is activated when the motor is in operation, power supply is present (network-ready) or no fault is present (ready for operation).

Factory setting: ready for operation. Both contacts signal the operating status of the twin-head pump in parallel (collective run signal).

Depending on the configuration, the contact is set to NO or NC.

To do this, select the following in the menu:

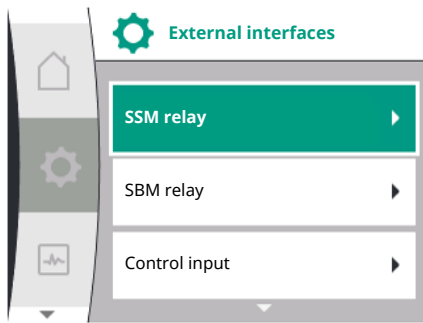

Fig. 33: External interfaces menu

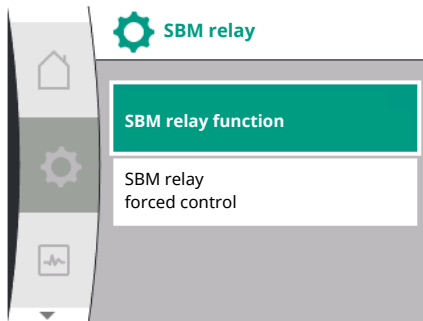

Fig. 34: Menu SBM-relay

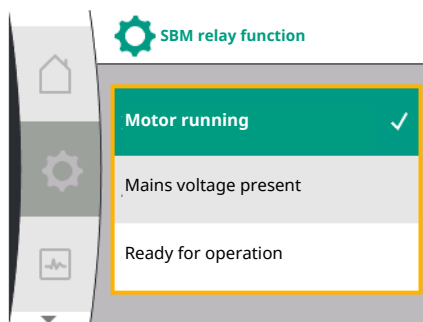

Fig. 35: SBM relay function menu

Universal	Display text
1.0	Settings
1.3	External interfaces
1.3.6	SBM relay
1.3.6.3	SBM relay function <sup>1</sup>
1.3.6.3 / 1	Motor running
1.3.6.3 / 2	Mains voltage present
1.3.6.3 / 3	Ready for operation

<sup>1</sup>Only appears if twin-head pump is configured.

Possible settings:

Selection option	Function SBM relay
Motor running (factory setting)	SBM relay connects when motor is running. Closed relay: The pump is supplying.
Mains voltage present	SBM relay connects for power supply. Closed relay: Voltage available.
Ready for operation	SBM relay connects when there is no fault. Closed relay: Pump can supply.

Table 15: Function SBM relay

### SBM/EBM (collective run signal/individual run signal) in twin-head pump operation

- **SBM:** The SBM contact can be assigned to any of the two pumps. Both contacts signal the operating status of the twin-head pump in parallel (collective run signal).
- **EBM:** The SBM function of the twin-head pump can be configured so that the SBM contacts signal only operational messages of the respective pump (individual run signal). In order to record run signals of both the pumps, both contacts must be assigned.

Universal	Display text
1.0	<b>Settings</b>
1.3	<b>External interfaces</b>
1.3.6	<b>SBM relay</b>
1.3.6.5 <sup>2</sup>	<b>Twin-head pump SBM relay function<sup>2</sup></b>
SBM	System mode (SBM)
EBM	Single pump mode (EBM)

<sup>2</sup> These sub-menus only appear when the twin-head pump is connected.

## 12.5 SBM relay forced control

An SBM relay forced control is used as function test of the SBM relay and electrical connections.

To do this, select the following in the menu:

Universal	Display text
1.0	Settings

Universal	Display text
1.3	External interfaces
1.3.6	SBM relay
1.3.6.7	SBM relay forced control
1.3.6.7 / 1	Normal
1.3.6.7 / 2	Forced active
1.3.6.7 / 3	Forced inactive

Selection options:

SBM relay Forced control	Help text
Normal	<b>SBM:</b> Depending on the SBM configuration, the pump status influences the SBM relay switching status.
Forced active	SBM relay switching status is forced ACTIVE. <b>CAUTION:</b> <b>SBM does not display the pump status!</b>
Forced inactive	SSM/SBM relay switching status is forced INACTIVE. <b>CAUTION:</b> <b>SBM does not display the pump status!</b>

Table 16: Selection option SBM relay forced control

The "Forced active" setting permanently activates the relay. This means that, for example, an operating note (light) is permanently displayed/announced.

The "Forced inactive" setting leaves the relay permanently without a signal. No operating note can be confirmed.

## 12.6 Application and function of the digital control input DI 1

The pump can be controlled through external potential-free contacts at the digital input 1. The pump can be switched on or off.

In the "Settings" menu , select:

Universal	Displaytext
<b>1.3</b>	<b>External interfaces</b>
<b>1.3.2</b>	<b>Binary input</b>
1.3.2.1	Binary input function
1.3.2.1/1	Not used
1.3.2.1/2	External OFF
1.3.2.1/3	Lack of water detection by switch
1.3.2.2	Double pump Ext. OFF function
1.3.2.2/1	System mode
1.3.2.2/2	Single pump mode
1.3.2.2/3	Combined mode

1. "External interfaces"
2. Select function "Binary input"
3. Select "Binary input function"

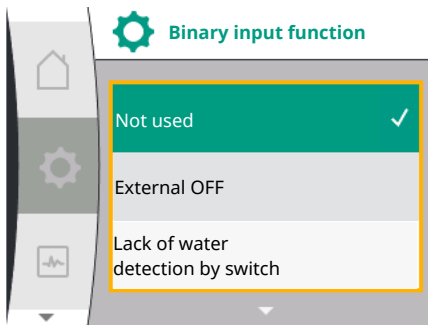

Possible settings:

Selected option	Digital input function
Not used	The control input does not have a function.
External OFF	<b>Contact open:</b> Pump is switched off <b>Contact closed:</b> Pump is switched on
Lack of water detection by switch	<b>Contact open:</b> Pump is switched off after the switch-off delay <b>Contact is closed:</b> Pump is switched on after the activation delay  NOTICE! This selection is only available if "Lack of water detection by switch" is enabled (see chapter 11.3.2: "Lack of water detection by binary input").  NOTICE! The configuration for the delay times is described (see chapter 11.3.2: "Lack of water detection by binary input").

Table 17: Function control input DI1

If the pump is in paired state and the binary function "External OFF" is selected, a new menu for configuration of double pump external off function appears in Menu ⚙️ "Settings"

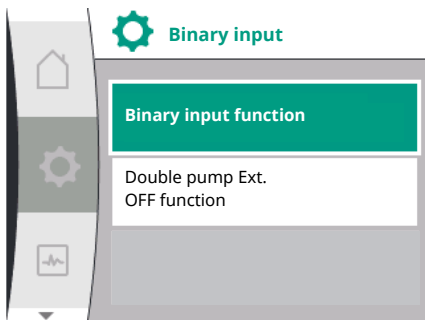

Universal	Displaytext
1.3	External interfaces
1.3.2	Binary input
1.3.2.2	Double pump Ext. OFF function
1.3.2.2/1	System mode
1.3.2.2/2	Single pump mode
1.3.2.2/3	Combined mode

1. "External interfaces"
2. "Binary input"

The menu item "Double pump external off function" appears with following selection options:

- System mode
- Single pump mode
- Combined mode

### Behaviour at Ext. OFF for double pumps

The function EXT. OFF always behaves as follows:

Ext. OFF active: Contact is open, pump is stopped (off)

Ext. OFF inactive: Contact is closed, pump is running in the control mode (on)

The double pump consists of two partners:

Main pump: Double pump partner with connected pressure sensor. Partner pump: Double pump partner without connected pressure sensor. The configuration of the control inputs has three possible modes for EXT. OFF which can influence the behaviour of the corresponding two pump partners.

The possible behaviours are described in the following tables.

### System mode

The control input of the main pump is connected with a control cable and on Ext. OFF. The control input on the main pump switches both double pump partners. The control input of the partner pump is ignored and has no meaning regardless of its configuration. If the main pump fails or the double pump connection is interrupted, the partner pump is also stopped.

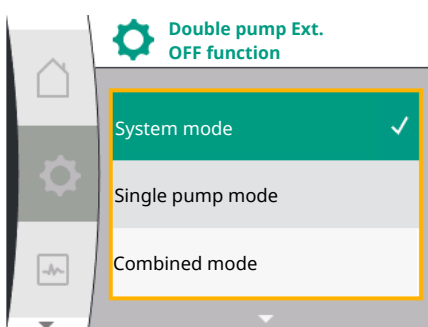

Main pump				Partner pump		
States	Ext. OFF	Pump motor behaviour	Display: Text at Active influences	Ext. OFF	Pump motor behaviour	Display: Text at Active influences
1	Active	OFF	OFF Override OFF (DI1)	Active	OFF	OFF Override OFF (DI1)
2	Not active	ON	OK Normal operation	Active	ON	OK Normal operation
3	Active	OFF	OFF Override OFF (DI1)	Not active	OFF	OFF Override OFF (DI1)
4	Not active	ON	OK Normal operation	Not active	ON	OK Normal operation

### Individual operation

The control input of the main pump and the control input of the partner pump are each assigned a control cable and are each configured on Ext. OFF. Each of the two pumps is individually switched by its own control input. If the main pump fails or the double pump connection is disconnected, the control input of the partner pump is evaluated. Alternatively, a cable bridge can be set at the partner pump instead of a separate control cable.

Main pump				Partner pump		
States	Ext. OFF	Pump motor behaviour	Display: Text at Active influences	Ext. OFF	Pump motor behaviour	Display: Text at Active influences
1	Active	OFF	OFF Override OFF (DI1)	Active	OFF	OFF Override OFF (DI1)
2	Not active	ON	OK Normal operation	Active	OFF	OFF Override OFF (DI1)
3	Active	OFF	OFF Override OFF (DI1)	Not active	ON	OK Normal operation
4	Not active	ON	OK Normal operation	Not active	ON	OK Normal operation

### Combined mode

The control input of the main pump and the control input of the partner pump are each assigned a control cable and are each configured on Ext. OFF. The control input of the main pump switches both double pump partners off. The control input of the partner pump only switches the partner pump off. If the main pump fails or the double pump connection is disconnected, the control input of the partner pump is evaluated.

Main pump				Partner pump		
States	Ext. OFF	Pump motor behaviour	Display: Text at Active influences	Ext. OFF	Pump motor behaviour	Display: Text at Active influences
1	Active	OFF	OFF Override OFF (DI1)	Active	OFF	OFF Override OFF (DI1)



Main pump				Partner pump		
2	Not active	ON	OK Normal operation	Active	OFF	OFF Override OFF (DI1)
3	Active	OFF	OFF Override OFF (DI1)	Not active	OFF	OFF Override OFF (DI1)
4	Not active	ON	OK Normal operation	Not active	ON	OK Normal operation



### NOTICE

The pump is switched on or off in regular operation via the DI input via Ext. OFF is preferable to switching the mains voltage.



### NOTICE

The 24 V DC power supply is only available if the analog input AI 1 or AI 2 has been configured for a type of use and a signal type or if the digital input DI 1 has been configured.

## 12.7 Application and function of the analogue inputs AI1 and AI2

The inverter has two analog inputs AI1 and AI2. These can be used for setpoint input or actual value input. The allocation of the setpoint and actual value specifications is depending on the selected control mode.

Set control mode	Function analogue input AI1	Function analogue input AI2
$\Delta p-v$	Configured as actual value input: <ul style="list-style-type: none"> <li>Type of use: Differential pressure sensor</li> </ul> Configurable: <ul style="list-style-type: none"> <li>Signal type</li> <li>Sensor measuring range</li> </ul>	Not Configured. Can be used as setpoint input
$\Delta p-c$	Configured as actual value input: <ul style="list-style-type: none"> <li>Type of use: Differential pressure sensor</li> </ul> Configurable: <ul style="list-style-type: none"> <li>Signal type</li> <li>Sensor measuring range</li> </ul>	Not Configured. Can be used as setpoint input
n-c	Not used	Not Configured. Can be used as setpoint input or pressure sensor input (suction pressure)
PID	Configured as actual value input: <ul style="list-style-type: none"> <li>Type of use: freely</li> </ul> Configurable: <ul style="list-style-type: none"> <li>Signal type</li> </ul>	Not Configured. Can be used as setpoint input or pressure sensor input (suction pressure)
p-c	Configured as actual value input: <ul style="list-style-type: none"> <li>Type of use: Pressure sensor</li> </ul> Configurable: <ul style="list-style-type: none"> <li>Signal type</li> <li>Sensor measuring range</li> </ul>	Not Configured. Can be used as setpoint input or pressure sensor input (suction pressure)

Set control mode	Function analogue input AI1	Function analogue input AI2
p-v	Configured as actual value input: <ul style="list-style-type: none"> <li>Type of use: Pressure sensor</li> </ul> Configurable: <ul style="list-style-type: none"> <li>Signal type</li> <li>Sensor measuring range</li> </ul>	Configured as actual value input: <ul style="list-style-type: none"> <li>Type of use: Pressure sensor</li> </ul> Configurable: <ul style="list-style-type: none"> <li>Signal type</li> <li>Sensor measuring range</li> <li>Sensor type</li> </ul>

The analog input AI 1 is used mainly as pressure value input. The Analog input AI2 is used mainly as the setpoint input, but with control modes n-c, PID, p-c and p-v, it can be used as sensor input for pressure sensor at suction port to support optional function "Lack of water detection via pressure sensor". In this case, the pressure sensor must be configured as AI 2 accordingly.

Overview of the terms for external interfaces and menu items for analog inputs AI1 and AI2 in the available languages:

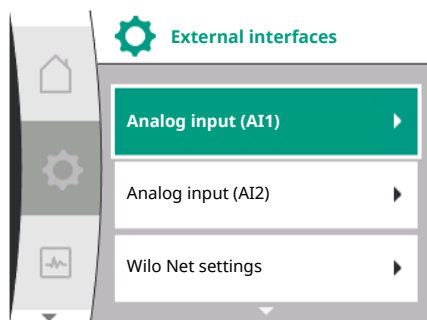

Universal	Displaytext
<b>1.3</b>	<b>External interfaces</b>
<b>1.3.3</b>	<b>Analog input (AI1)</b>
1.3.3.1	Signal type (AI1)
1.3.3.2	Pressure sensor range (AI1)
<b>1.3.4</b>	<b>Analog input (AI2)</b>
1.3.4.1	Signal type (AI2)
1.3.4.2	Pressure sensor range (AI2)
1.3.4.3	Pressure sensor type (AI2)
1.3.4.3 /1	Absolute pressure sensor
1.3.4.3 /2	Relative pressure sensor



## NOTICE

The 24 V DC power supply is only available if the analog input AI 1 or AI 2 has been configured for a type of use and a signal type or if the digital input DI 1 has been configured.

### 12.7.1 Use of analogue input AI 1 as sensor input (actual value)

The actual value sensor provides:

- Differential pressure sensor values for:
  - Differential pressure control
- Relative pressure sensor value for:
  - Constant pressure control
  - Variable pressure control
- User-defined sensor values for:
  - PID control

When setting the control mode, the type of use of analogue input AI 1 is automatically pre-configured as an actual value input.

The signal type can be set in the "Setting" menu  via:

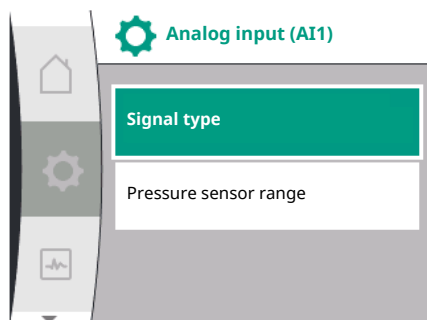

Universal	Displaytext
<b>1.3</b>	<b>External interfaces</b>
<b>1.3.3</b>	<b>Analog input (AI1)</b>
1.3.3.1	Signal type (AI1)
1.3.3.2	Pressure sensor range (AI1)

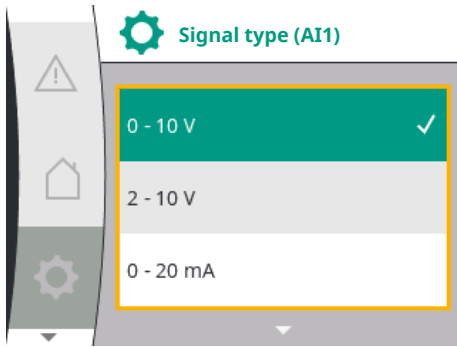

1. "External interfaces"
2. "Analogue input AI 1"

The menu item "Signal type" appears with following selection options:

- 0 - 10 V
- 2-10V
- 0-20mA
- 4-20mA

#### Signal type (AI 1) setting

Possible signal types when selecting the analogue input as actual value input: Actual value sensor signal types:

#### Actual value sensor signal types

- **0 – 10 V:** Voltage range of 0 ... 10 V for transfer of measurement values.
- **2–10V:** Voltage range of 2 ... 10 V for the transfer of measurement values. Cable break is detected for a voltage below 1V.
- **0–20mA:** Electric current range of 0 ... 20 mA for the transfer of measured values.
- **4–20mA:** Electric current range of 4 ... 20 mA for the transfer of measured values. A cable break is detected if the electric current is less than 2 mA.

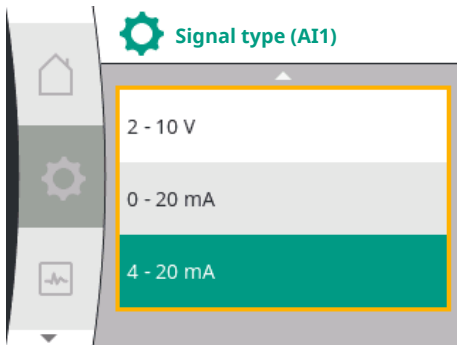

The pressure sensor range can be set in the "Settings" menu ⚙ via:

Universal	Displaytext
<b>1.3</b>	<b>External interfaces</b>
<b>1.3.3</b>	<b>Analog input (AI1)</b>
1.3.3.1	Signal type (AI1)
1.3.3.2	Pressure sensor range (AI1)

1. "External interfaces"
2. "Analogue input AI 1"
3. "Pressure sensor range AI 1"

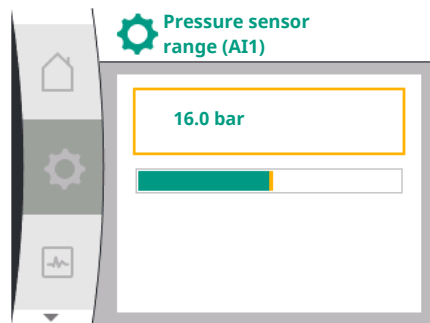

### 12.7.2 Use of analogue input AI 2

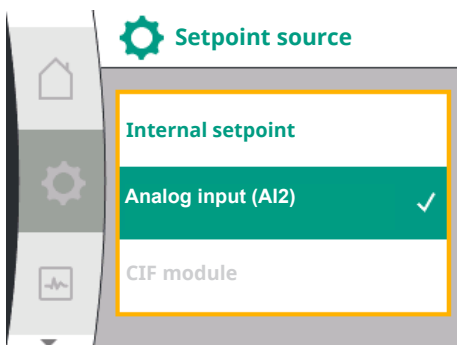

#### Analog Input used as Setpoint Source:

The setting of the Analog input (AI2) as Setpoint source is only available in the menu if the Analog input (AI2) was previously selected in the menu "Settings" ⚙ in this sequence:

1. "Control setting"
2. "Setpoint source"

Via the menu ⚙ "Settings" the signal type (0 – 10 V, 0 – 20 mA, ...) is set in this sequence:

Universal	Displaytext
<b>1.3</b>	<b>External interfaces</b>
<b>1.3.4</b>	<b>Analog input (AI2)</b>
1.3.4.1	Signal type (AI2)
1.3.4.2	Pressure sensor range (AI2)
1.3.4.3	Pressure sensor type (AI2)
1.3.4.3 /1	Absolute pressure sensor
1.3.4.3 /2	Relative pressure sensor

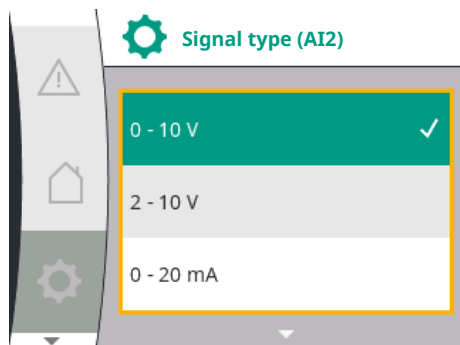

1. "External interfaces"
2. "Analogue input AI 2"

The menu item "Signal type" appears with following selection options:

- 0 - 10 V
- 2-10V
- 0-20mA
- 4-20mA

Signal type (AI2) setting

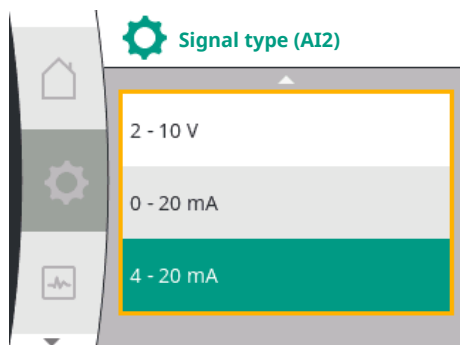

#### Setpoint signal source (AI2):

- **0-10V:** Voltage range of 0-10V for transfer of setpoint values.
- **2-10V:** Voltage range of 2-10V for transfer of setpoint values. If the voltage is below 1 V, the motor is switched off and cable break is detected (see Overview of transfer functions).
- **0-20mA:** Electric current range of 0-20mA for transfer of setpoints.
- **4-20mA:** Electric current range of 2-20mA for transfer of setpoints. If the current is below 2 mA, the motor is switched off and cable break is detected (see Overview of transfer functions).



#### NOTICE

After selecting one of the external sources, the setpoint is paired to this external source and can no longer be adjusted in the setpoint editor or in the home screen. This pairing can be cancelled again in the menu "Setpoint source". The setpoint source must be adjusted again to "Internal setpoint". The coupling between external source and setpoint is marked both in the home screen, and in the setpoint editor in **blue**. The status LED also becomes blue.

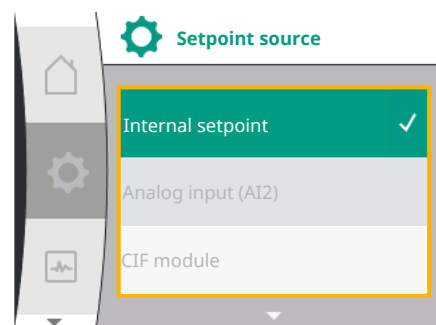

#### Analog Input used as Suction Pressure sensor input:

If the function "Variable pressure p-v" or the optional function "Lack of water detection via pressure sensor" is activated, the AI2 can not be configured as setpoint source for the control mode, the option is greyed out.

In this case, the configuration of AI 2 for pressure sensor usage becomes available in the menu "Settings"

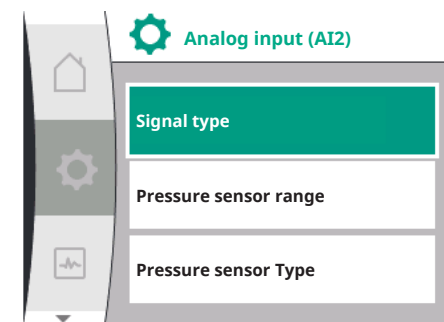

Universal	Displaytext
<b>1.3</b>	<b>External interfaces</b>
<b>1.3.4</b>	<b>Analog input (AI2)</b>
1.3.4.1	Signal type (AI2)
1.3.4.2	Pressure sensor range (AI2)
1.3.4.3	Pressure sensor type (AI2)
1.3.4.3 /1	Absolute pressure sensor
1.3.4.3 /2	Relative pressure sensor

1. "External interfaces"
2. "Analog input (AI2)"

The following options are configurable:

- Signal type
- Pressure sensor range
- Pressure sensor Type

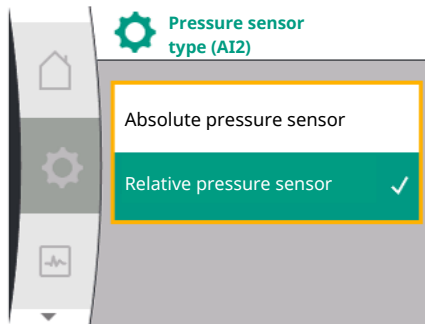
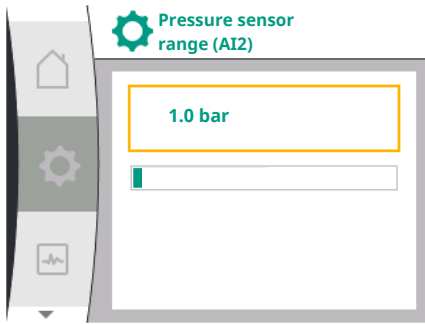

### 12.7.3 Transfert function

#### Pressure sensor signal type:

- **0–10V**: Voltage range of 0–10V for transfer of setpoint values.
- **2–10V**: Voltage range of 2–10V for transfer of setpoint values. If the voltage is below 1 V, the motor is switched off and cable break is detected (see Overview of transfer functions).
- **0–20 mA**: Electric current range of 0–20 mA for transfer of setpoints.
- **4–20 mA**: Electric current range of 2–20 mA for transfer of setpoints. If the current is below 2 mA, the motor is switched off and cable break is detected (see Overview of transfer functions).

#### Pressure sensor range

In menu item "Pressure sensor range" the pressure sensor range can be selected.

#### Pressure sensor type

In menu item "Pressure sensor type" an absolute or a relative pressure sensor type can be selected.

#### Setpoint input and transfer function

##### Setpoint inputs 0 V ... 10 V, 0 mA ... 20 mA:

At 0 V ... 10 V, 0 mA ... 20 mA, the cable break section does not apply.

The default values for linear section and motor off section are shown on the figure Fig. 36.

In constant speed n-c, setpoint can be set from 30% of maximum speed up to maximum speed.

For other control functions (dp-v, dp-c, PID and pc), the setpoint can be set from 0 % to 100 % of the sensor range.

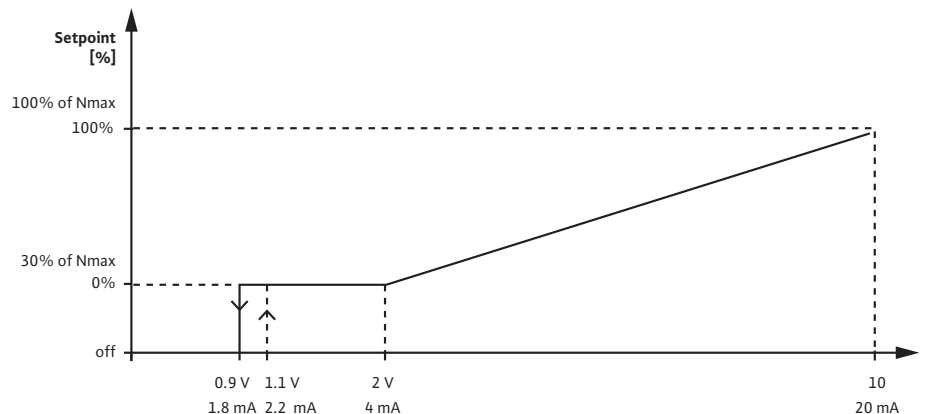

Fig. 36: Setpoint input 0 – 10V or 0 – 20mA

If analog signal is smaller than 0.9 V or 1.8 mA, the motor is switched off. The cable break detection is not active. With an analog signal between 2 V and 10 V or between 4 mA and 20 mA, signal is interpolated linearly. The applied analog signal of 0.9 ... 2 V or 1.8 ... 4 mA represents the setpoint at "0 %" or minimum speed. The analog signal of 10 V or 20 mA represents the setpoint at "100 %" or maximum speed.

##### Setpoint inputs 2 V ... 10 V, 4 mA ... 20 mA:

The default values for linear section, motor off section and cable break section are shown on the figure Fig. 37.

In constant speed n-c, setpoint can be set from 30% of maximum speed up to maximum speed.

For other control functions, dp-c, dp-v, PID and pc, setpoint can be set from 0 % to 100 % of the sensor range.

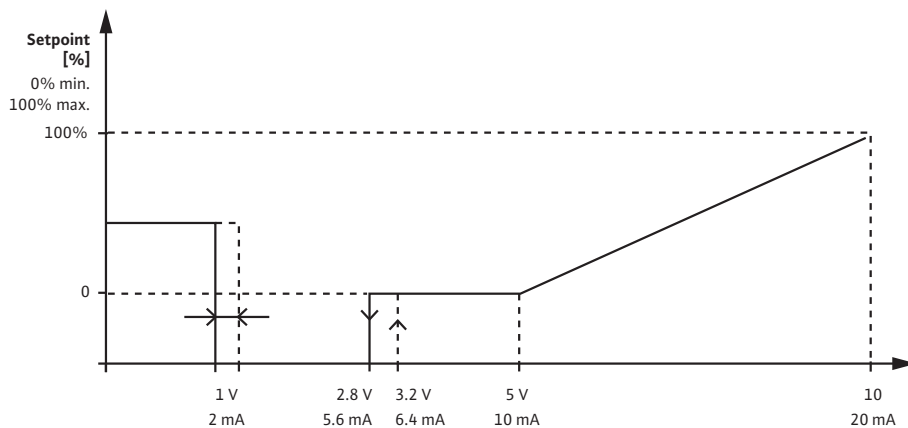

Fig. 37: Setpoint Input 2 – 10V or 4–20mA

An analog signal smaller than 1 V or 2 mA is detected as a cable break. In this case a substitute setpoint takes effect. The substitute setpoint is set in the menu "Control setting". With an analog signal between 1 V and 2.8 V or between 2 mA and 5.6 mA, the motor is switched off. With an analog signal between 5 V and 10 V or between 10 mA and 20 mA, signal is interpolated linearly. The applied analog signal of 2.8 ... 5 V or 5.6 ... 10 mA represents the setpoint at "0 %" or minimum speed. The analog signal of 10 V or 20 mA represents the setpoint at "100 %" or maximum speed.

### Sensor input and transfer function

#### Sensor inputs 0 V ... 10 V, 0 mA ... 20 mA:

At 0 V ... 10 V, 0 mA ... 20 mA, only the linear section is applied.

The default values for linear section is shown on the figure Fig. 38.

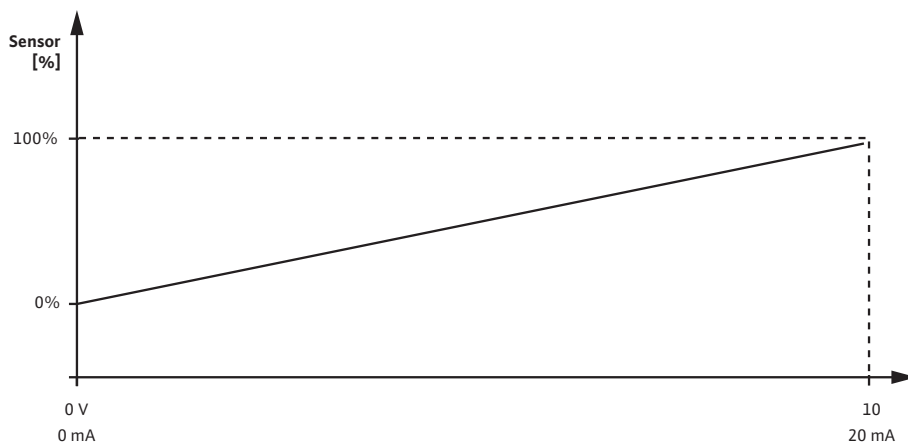

Fig. 38: Sensor input 0–10V or 0–20mA

The applied analog signal of 0 V or 0 mA represents the actual value of the pressure at "0 %". The analog signal of 10 V or 20 mA represents the actual value of the pressure at "100 %".

#### Sensor inputs 2 V ... 10 V / 4 mA .. 20 mA:

At 2 V ... 10 V / 4 mA .. 20 mA the motor off section does not apply. The default values for the linear section and cable break section are shown on the figure Fig. 39.

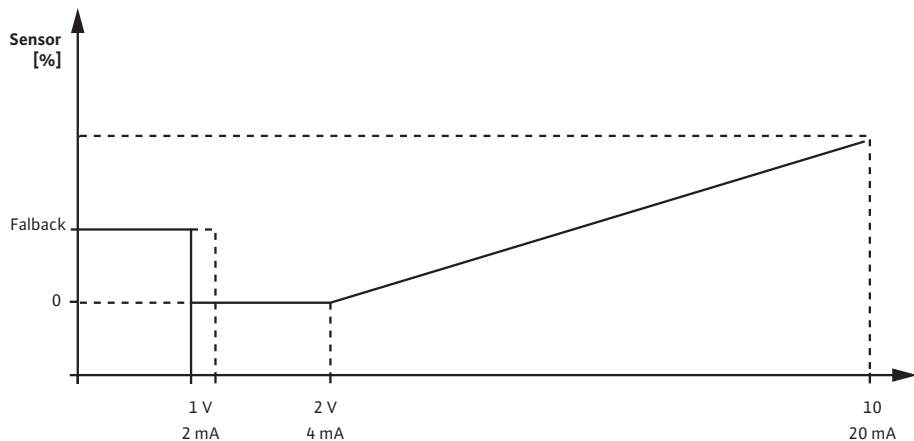

Fig. 39: Sensor input 0–10V or 0–20mA

An analog signal smaller than 1 V or 2 mA is detected as a cable break. An emergency operation speed is then used as emergency operation. For this purpose the emergency operation must be set to "Pump ON" in the menu "Control setting – Emergency operation". If the emergency operation is set to "Pump OFF", the motor of the pump is switched off when a cable break is detected. The applied analog signal of 1 ... 2 V or 2 ... 4 mA represents the actual value of the pressure at "0 %". The analog signal of 10 V or 20 mA represents the actual value of the pressure at "100 %".

**12.8 Application and function of the Wilo Net interface**

Wilo Net is a bus system which enables up to 21 Wilo products (participants) to communicate with one another. The Wilo-Smart Gateway is one of these participants.

**Application for:**

- Double pumps consisting of two participants
- Remote access via Wilo-Smart Gateway

**Bus topology:**

The bus topology consists of multiple participants (pumps and Wilo-Smart Gateway), which are switched on in sequence. The participants are connected via a shared cable. The bus has to be terminated on both ends of the cable. This is done for the two external pumps in the pump menu. All other subscribers should not have activated termination. All bus subscribers must be assigned an individual address (Wilo Net ID). This address is set in the pump menu of the respective pump.

To terminate the pumps:

In the "Settings" menu ⚙️, select:

Universal	Displaytext
<b>1.3</b>	<b>External interfaces</b>
<b>1.3.5</b>	<b>Wilo Net settings</b>
1.3.5.1	Wilo Net termination
1.3.5.2	Wilo Net address

1. "External interfaces"
2. "Wilo Net setting"
3. "Wilo Net termination"

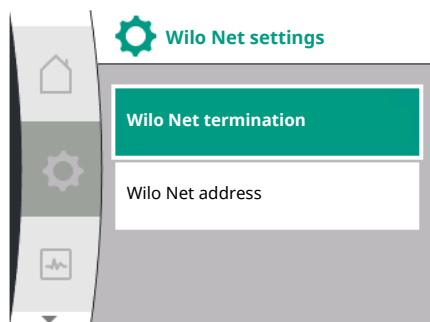

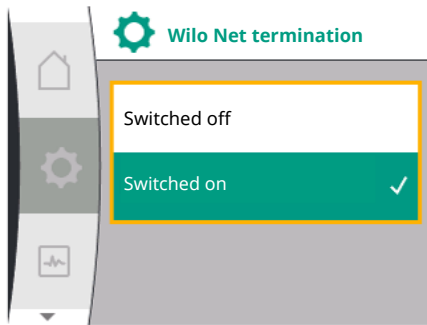

Possible selection:

Wilо Net termination	Description
Switched on	Terminating resistor of the pump is switched on. If the pump is connected at the end of the electrical bus line, "Switched on" must be selected.
Switched off	The pump's terminating resistor is switched off. If the pump is NOT connected at the end of the electrical bus line, "Switched off" must be selected.

After termination is done, an individual Wilо Net address is assigned to the pumps:

In the "Settings" menu , select:

Universal	Displaytext
<b>1.3</b>	<b>External interfaces</b>
<b>1.3.5</b>	<b>Wilо Net settings</b>
1.3.5.1	Wilо Net termination
1.3.5.2	Wilо Net address

1. "External interfaces"
2. "Wilо Net setting"
3. "Wilо Net address" and assign an address (1...21).



### NOTICE

The settings range for the Wilо Net address is 1...126, all values in the range 22...126 must not be used.

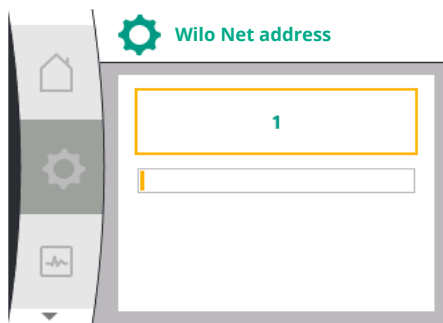

### Double pump example:

- Pump installed at left side (I)  
Wilо Net termination: ON  
Wilо Net address: 1
- Pump installed on right side (II)  
Wilо Net termination: ON  
Wilо Net address: 2

## 12.9 Application and function of CIF module

Depending on the type of CIF module inserted, a  "Settings", "External interfaces" associated settings menu is displayed in the menu.

The required settings of the CIF modules in the pump are described in the user manual of the CIF modules.

## 13 Display settings

Overview of the terms in the display for selecting the double pump management in the available languages:

Universal	Display text
<b>1.5</b>	<b>Display settings</b>
<b>1.5.1</b>	<b>Display brightness</b>
<b>1.5.2</b>	<b>Language</b>
<b>1.5.3</b>	<b>Unit</b>
<b>1.5.4</b>	<b>Key lock</b>
1.5.4.1	Key lock ON

General settings are made under  "Settings", "Display settings".



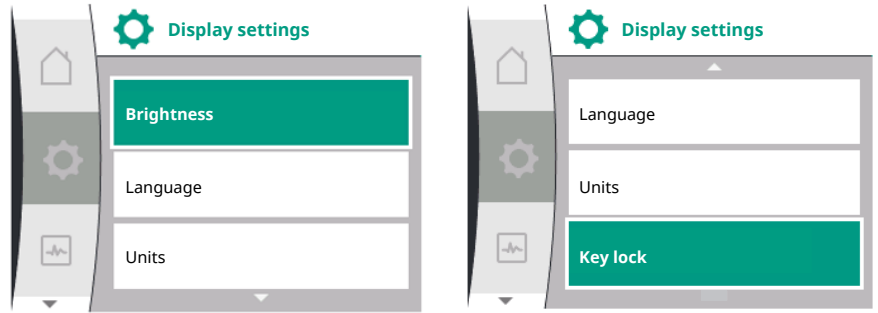

- Brightness
- Language
- Units
- Key lock

**13.1 Brightness**

Under "Settings" ⚙️

1. "Display settings"
2. Brightness

The display brightness can be changed. The level of brightness is shown in a percentage. 100 % brightness corresponds to maximum possible, 5 % is the minimum possible brightness.

**13.2 Language**

Under "Settings" ⚙️

1. "Display settings"
2. Language

The language can be set.

See Chapter 9.3.3 – Initial settings menu



**NOTICE**

After selecting a language other than the one currently set, the display may switch off and restart. During this process, the green LED flashes. After the display has restarted, the language selection list appears with the activated, newly selected language. This process can take up to approx. 30 seconds.

In addition to the possibility to select a language, there is the option to choose a language-independent menu.

**13.3 Units**

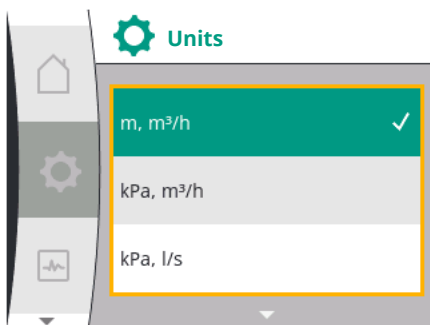

Under "Settings" ⚙️

Universal	Display text
1.5	Display settings
1.5.1	Display brightness
1.5.2	Language
1.5.3	Unit
1.5.4	Key lock
1.5.4.1	Key lock ON

1. "Display settings"
2. Units

you can set units for physical values.

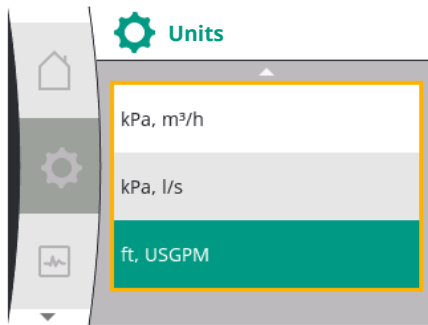

Selection of options units:

Units	Description
SI Units 1: m. m <sup>3</sup> /h	Representation of physical values in SI units <b>Exception:</b> <ul style="list-style-type: none"> <li>Flow rate in m<sup>3</sup>/h</li> <li>Delivery head in m</li> </ul>
SI Units 2: KPa. m <sup>3</sup> /h	Representation of delivery head in kPa
SI Units 3: KPa. l/s	Representation of delivery head in kPa and volume flow in l/s
SI Units 4: USGPM	SI Units 4: Representation of physical values in US units



**NOTICE**

Units are set to SI units as a factory setting.

**13.4 Key lock ON**

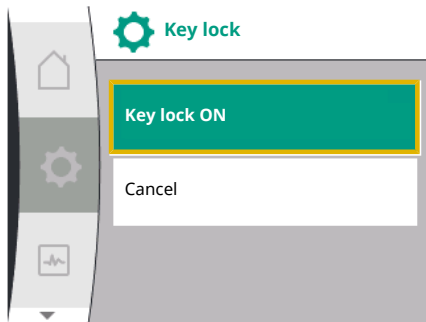

The key lock function prevents accidental change of pump parameters by unauthorised persons.

Under "Settings" ⚙️

Universal	Display text
<b>1.5</b>	<b>Display settings</b>
<b>1.5.1</b>	<b>Display brightness</b>
<b>1.5.2</b>	<b>Language</b>
<b>1.5.3</b>	<b>Unit</b>
<b>1.5.4</b>	<b>Key lock</b>
1.5.4.1	Key lock ON

1. "Display settings"
2. "Key lock"

You can activate or deactivate the key lock by pressing the "Operating button" for a time longer than 5 seconds. The home screen and warning as well as error messages are also displayed when the key lock is active so you can monitor the pump status.

A lock symbol  indicates an activated key lock.

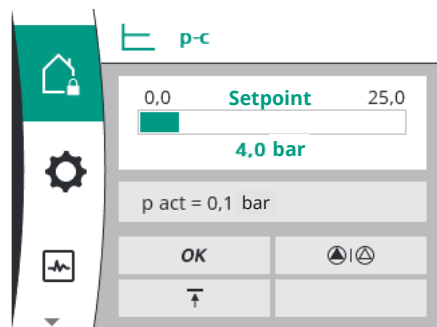

**14 Additional settings**

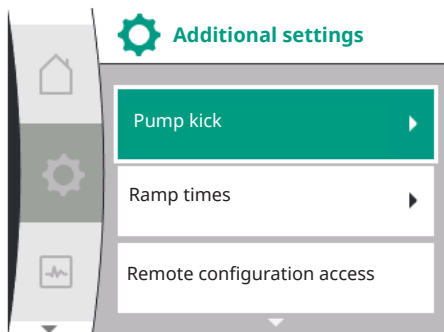

Overview of the terms in the display for selecting the additional settings in the available languages:

Universal	Display text
<b>1.6</b>	<b>Additional settings</b>
<b>1.6.1</b>	<b>Pump kick</b>
1.6.1.1	Pump kick: ON/OFF
1.6.1.2	Pump kick: Interval
1.6.1.3	Pump kick: Speed
<b>1.6.2</b>	<b>Ramp times</b>
1.6.2.1	Ramp times: Start-up time
1.6.2.2	Ramp times: Switch-off period
<b>1.6.4</b>	<b>Automatic PWM frequency reduction</b>
<b>1.6.5</b>	<b>Fluid correction</b>

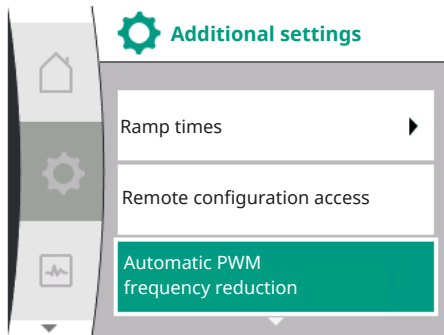

## 14.1 Pump kick

The functions "Pump kick", "Ramp times", "Remote configuration", "Automatic PWM frequency reduction" and "Fluid mixture correction" are set:

Under "Settings" ⚙️

1. "Additional settings"

In order to prevent blocking of the pump, a pump kick is set on the pump. After a set time interval, the pump starts and switches off after a short time. Prerequisite:

For the pump kick function, the mains voltage must not be interrupted.



### CAUTION

#### Blockage of the pump due to long downtimes!

Long downtimes may lead to blockage of the pump. Do not deactivate pump kick!



### NOTICE

Via remote control, bus command, external control input OFF or 0 ...10 V signal of pumps that are switched off will start briefly. This prevents blockage after long downtimes.

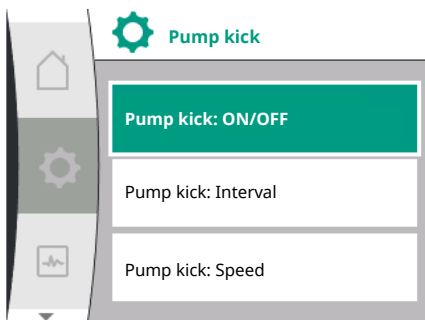

Fig. 40: Pump kick setting

In the "Settings" menu ⚙️, select:

Universal	Display text
<b>1.6</b>	<b>Additional settings</b>
<b>1.6.1</b>	<b>Pump kick</b>
1.6.1.1	Pump kick: ON/OFF
1.6.1.2	Pump kick: Interval
1.6.1.3	Pump kick: Speed

1. "Additional settings"
2. "Pump kick"
  - The pump kick can be switched on and off.
  - The time interval for the pump kick can be set between 2 and 72 hours (factory setting: 24 hours).
  - The pump speed at which the pump kick is performed can be set.



### NOTICE

When it is planned to switch off the mains voltage for a longer period of time, the pump kick must be performed using an external control by switching on the mains voltage briefly. For this purpose, the pump must be switched on by the controller before the power supply is interrupted.

## 14.2 Setting pump ramp times

In the "Settings" menu ⚙️

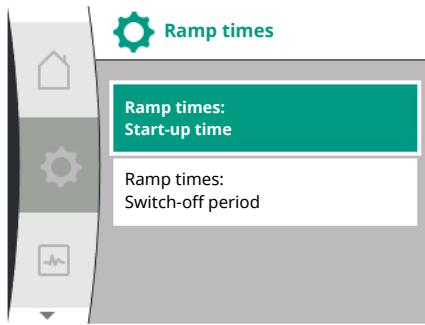

### 14.3 PWM frequency reduction

Universal	Display text
<b>1.6</b>	<b>Additional settings</b>
<b>1.6.2</b>	<b>Ramp times</b>
1.6.2.1	Ramp times: Start-up time
1.6.2.2	Ramp times: Switch-off period

1. "Additional settings"
2. "Ramp times"

The ramp times define how fast the pump may start up and shut down at the maximum when the setpoint is changed.

In the "Settings" menu 

Universal	Display text
<b>1.6</b>	<b>Additional settings</b>
<b>1.6.4</b>	<b>Automatic PWM frequency reduction</b>

1. "Additional settings"
2. "Automatic PWM frequency reduction"

The "Automatic PWM frequency reduction" function is switched off at the factory. If the ambient temperature is too high, the pump will automatically reduce its hydraulic power due to the too high temperature inside the drive. If this reduced hydraulic power leads to a too low pump output for the application, it is possible to automatically reduce the PWM frequency of the converter by switching it ON via this menu.

As a result, the pump automatically switches to a lower PWM frequency when a critical, defined temperature in the drive is reached. By doing so, the required pump output is achieved.



#### NOTICE

Due to the automatic PWM frequency reduction, the operating noise of the pump can increase or change.

### 14.4 Fluid correction

In the "Settings" menu 

Universal	Display text
<b>1.6</b>	<b>Additional settings</b>
<b>1.6.5</b>	<b>Fluid correction</b>
1.6.5.1	Fluid mixture correction: ON/OFF
1.6.5.2	Fluid mixture correction: Viscosity
1.6.5.3	Fluid mixture correction: Density

1. "Additional settings"
2. "Fluid mixture correction"

To improve flow detection for viscous fluid (e.g. water-ethylene glycol mixtures), a fluid correction can be made. If "Switched on" is selected in the menu, the viscosity and density of the fluid can be entered in the menu item that appears. The values must be known by the customer.

## 15 Diagnostics and measured values

In order to support fault analysis, the pump provides additional help apart from fault notifications:

The Diagnostics help and the measured values are used for diagnosis and maintenance of electronics and interfaces. Apart from hydraulic and electrical overviews, information about interfaces and device information are provided.

Overview of the terms in the display for selecting the diagnostics and measured values in the available languages:

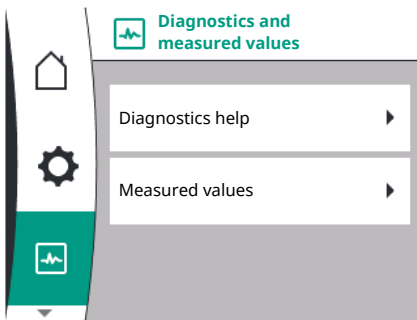

Universal	Display text
2	Diagnosis and measured values
2.1	Diagnostics help
2.1.1	Device information
2.1.2	Service information
2.1.3	Overview of SSM relay
2.1.4	Overview of analog input (AI1)
2.1.5	Overview of analog input (AI2)
2.1.6	Double pump connection info
2.1.7	Pump cycling status
2.1.8	Failure details
2.1.9	Overview of SBM relay
2.2	Measured values
2.2.1	Operating data
2.2.2	Statistics data

## 15.1 Diagnostics help

In order to support fault analysis, the pump provides additional help apart from displaying errors. Diagnostics help is used for diagnosis and maintenance of electronics and interfaces. Apart from hydraulic and electrical overviews, information about interfaces, device information and manufacturer's contact data are provided in the  "Diagnosis and measured values" menu.

Specifically, these are:

- Device information
- Service information
- Failure details
- Overview of SSM and SBM relays
- Overview of the analogue inputs AI1 and AI2
- Overview of the double pump connection
- Overview of the pump cycling status

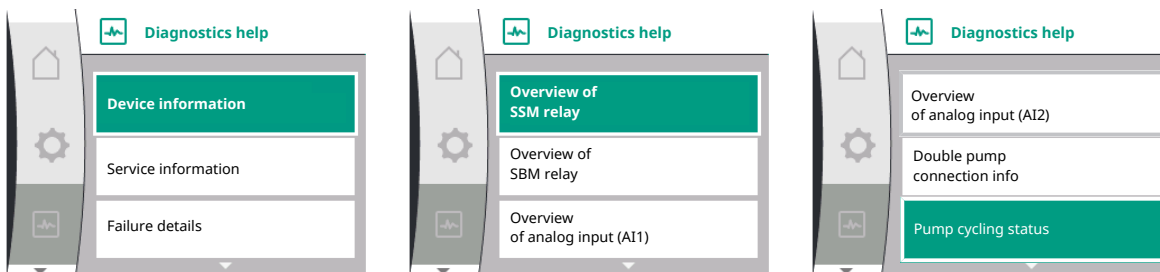

Diagnostics	Description	Display
Device information	Display of different device information	<ul style="list-style-type: none"> <li>• Pump type</li> <li>• Article number</li> <li>• Serial number</li> <li>• Software version</li> </ul>
Service information	Display of different manufacturer-specific device information	<ul style="list-style-type: none"> <li>• Hardware version</li> <li>• Parametrisation</li> </ul>
Failure details	Display of failure information	<ul style="list-style-type: none"> <li>• Error code</li> <li>• Error message</li> </ul>
Overview of SSM and SBM relay status	Overview of the current relay usage e.g. relay function SSM, forced control OFF, not active	<ul style="list-style-type: none"> <li>• Relay function</li> <li>• Forced control</li> <li>• Status</li> </ul>
Overview of Analog input (AI1)	Overview of settings e.g. type of use relative pressure sensor, Signal type 0–10 V, 3.3V	<ul style="list-style-type: none"> <li>• Type of use</li> <li>• Signal type</li> <li>• Signal value</li> </ul>

Diagnostics	Description	Display
Overview of Analog input (AI2)	Overview of settings e.g. Type of use setpoint input, signal type 4 – 20 mA, 12.0mA	<ul style="list-style-type: none"> <li>Type of use</li> <li>Signal type</li> <li>Signal value</li> </ul>
Overview of the double pump connection	Overview of the double pump connection e.g. Partner paired, address 2, Partner name Helix2.0 VE 1602	<ul style="list-style-type: none"> <li>Partner ID</li> <li>Partner address</li> <li>Partner name</li> </ul>
Overview of pump cycling status	Overview of pump cycling status e.g. Switch ON, interval 24h, no pump running, Next execution 1d 0h 0m	<ul style="list-style-type: none"> <li>Time base</li> <li>Status</li> <li>Next execution</li> </ul>
Overview of operating data	Overview of current operating data e.g. delivery pressure p act 4.0bar, speed 2540/Min, Power 1520W, voltage 230V	<ul style="list-style-type: none"> <li>Delivery head or pressure</li> <li>Speed</li> <li>Power consumption</li> <li>Mains voltage</li> </ul>
Overview of statistics data	Overview of statistics data Overview of current statistics data. e.g. energy 746 kWh, hours 23442 h	<ul style="list-style-type: none"> <li>Consumed power</li> <li>Operating hours</li> </ul>

Table 18: Selection options – Diagnostics help

### 15.1.1 Device information

In the “Diagnostics and measured values” menu 

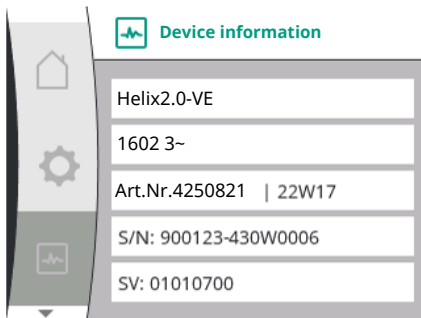

Universal	Display text
2.1	Diagnostics help
2.1.1	Device information

- "Diagnostics help"
- "Device information"

you can read information about product names, the product and serial number as well as software and hardware version.

### 15.1.2 Service information

In the “Diagnostics and measured values” menu 

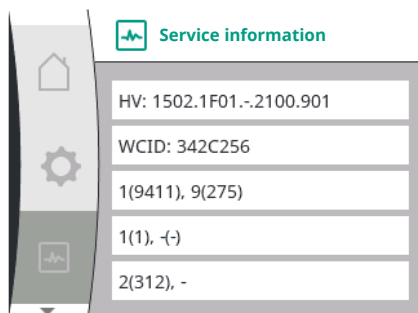

Universal	Display text
2.1	Diagnostics help
2.1.2	Service information

- "Diagnostics help"
- "Service information"

further information for service purposes about the product can be read.

### 15.1.3 Error details

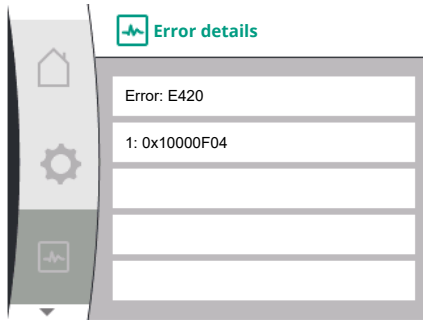

Fig. 41: Error details menu

### 15.1.4 Overview of the SSM relay status

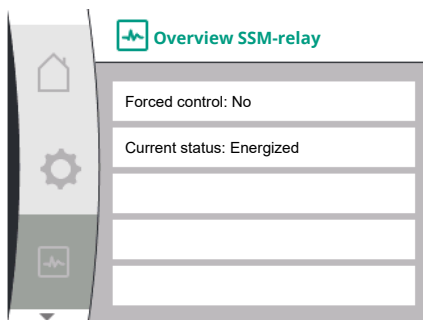

Fig. 42: Overview of the relay function SSM

### 15.1.5 Overview of the SBM relay status

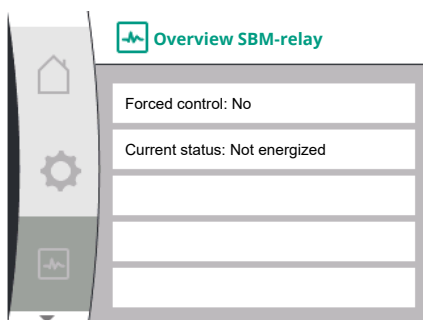
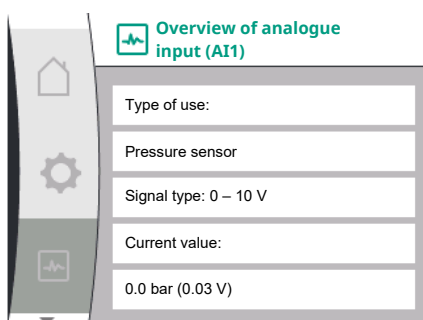



Fig. 43: Overview of the relay function SSM

### 15.1.6 Overview of the analogue inputs AI1 and AI2



Universal	Display text
2.0	Diagnostics and measured values
2.1	Diagnostics help
2.1.8	Error details

You can read the status information on the SSM relay in the menu  “Diagnostics and measured values”. To do this, select the following:

Universal	Display text
2.0	Diagnostics and measured values
2.1	Diagnostics help
2.1.3	Overview SSM-relay
Relay function: SSM	Relay function: SSM
Forced control: Yes	Forced control: Yes
Forced control: No	Forced control: No
Current status: Energized	Current status: Energized
Current status: Not energized	Current status: Not energized

You can read the status information on the SBM relay in the menu  “Diagnostics and measured values”. To do this, select the following:

Universal	Display text
2.0	Diagnostics and measured values
2.1	Diagnostics help
2.1.9	Overview SBM-relay
Relay function: SBM	Relay function: SBM
Forced control: Yes	Forced control: Yes
Forced control: No	Forced control: No
Current status: Energized	Current status: Energized
Current status: Not energized	Current status: Not energized

In the “Diagnostics and measured values” menu .

Universal	Display text
2.1	Diagnostics help
2.1.4	Overview of analog input (AI1)
2.1.5	Overview of analog input (AI2)

1. “Diagnostics help”
2. “Overview of analogue input AI 1” or
3. “Overview of analogue input AI 2”

status information on analogue input AI 1/AI 2 can be read:

- Type of use

- Signal type
- Current measured value

Behaviour of analogue input AI1:

### 15.1.7 Overview of the double pump connection

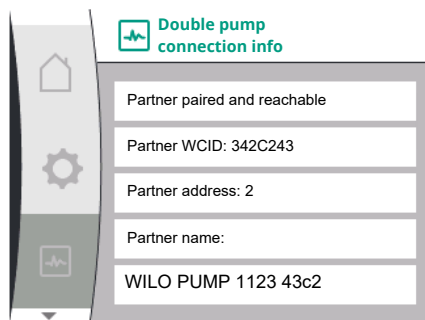

In the “Diagnostics and measured values” menu :

Universal	Display text
2.1	Diagnostics help
2.1.6	Double pump connection info

1. “Diagnostics help”
2. “Overview of double pump connection”

status information on the double pump connection can be read.



#### NOTICE

The double pump connection overview is only available if a double pump connection has been previously configured (see “Dual pump management” section).

### 15.1.8 Overview of pump cycling status

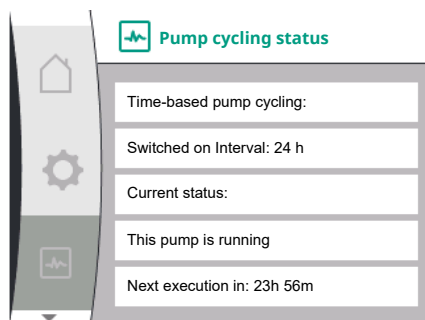

In the “Diagnostics and measured values” menu :

Universal	Display text
2.1	Diagnostics help
2.1.7	Pump cycling status

1. “Diagnostics help”
2. “Overview of pump cycling status”

Status information on pump cycling can be read:

- Pump cycling active: Yes /no

The following additional information is available when pump cycling is switched on:

- Current status: no pump running/both pumps running/this pump running/other pump running
- Time until next pump cycling

## 15.2 Measured values

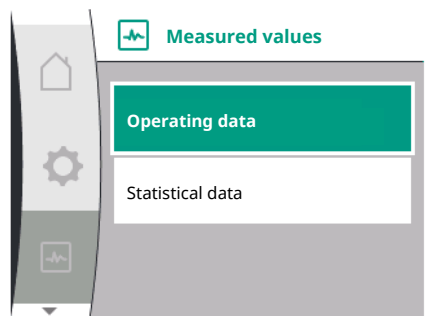

In the menu  “Diagnostics and measured values” there are:

Universal	Displaytext
2.2	Measured values
2.2.1	Operating data

1. “Measured values”

operating data, measurement data and statistical data are displayed.

In the submenu “Operating Data” the following information can be read:

#### Hydraulic operating data

- Current delivery head
- Current suction pressure value
- Actual speed

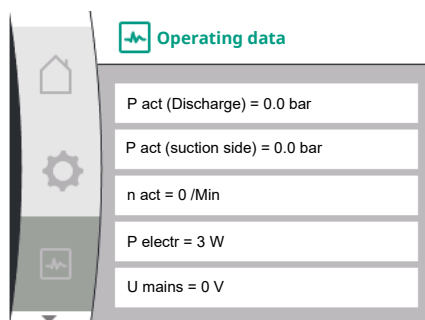



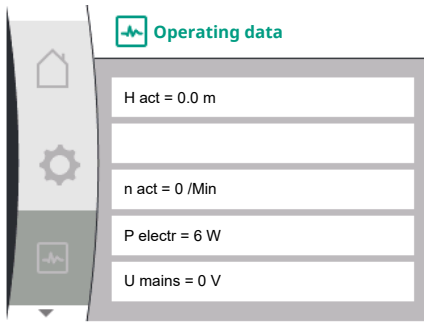

**Electrical operating data**

- Power consumption
- Mains voltage



**NOTICE**

The data given in this figure is dependent on the configured control mode. The “p<sub>act</sub>” (discharge side) actual value is provided if a discharge pressure sensor (p-c, p-v) is used. The “p<sub>act</sub>” actual value (suction side) is provided if a suction pressure sensor is used.

The H act value is given if a differential pressure sensor (dp-c, dp-v) is in use.

In the submenu “Statistics Data” the following information can be read:

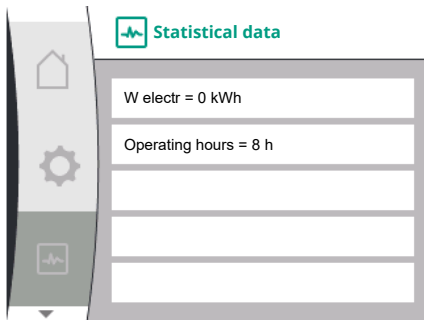

Universal	Displaytext
2.2	Measured values
2.2.2	Statistics data

Statistical data

- Total energy absorbed
- Operating hours

**16 Reset**

In this menu, the factory settings of the pump can be restored.

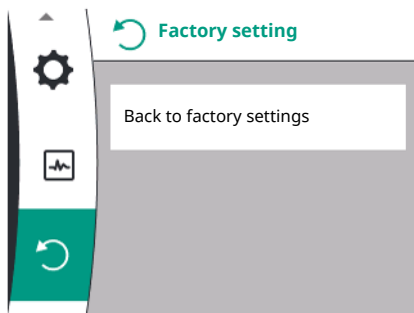

**16.1 Factory setting**

The pump can be reset to factory settings. In the “Reset” menu, select:

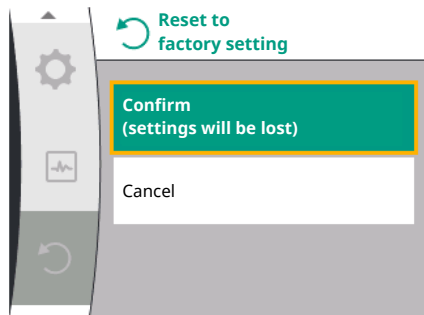

Universal	Display text
3.0	Factory setting
3.1	Restore factory setting

1. “Factory setting”
2. “Restore factory setting”
3. and “Confirm factory setting” in this sequence



**NOTICE**

Resetting pump settings to factory settings replaces the current pump settings!

Parameters	Factory setting
<b>Control settings</b>	
Control mode	Basic control mode - n-const.
Setpoint n-c	(Maximum speed + Minimum speed) / 2
Setpoint source	Internal setpoint

Parameters	Factory setting
Pump On/Off	Switched on
<b>Monitoring settings</b>	
Min. pressure detection	Switched off
Max. pressure detection	Switched on
Maximum pressure for limit detection	
Helix2.0-VE	16 bar
Medana CH3-LE	10 bar
Max. pressure detection delay	20s
Lack of water detection by sensor	Switched off
Lack of water detection by switch	Switched off
<b>External interfaces</b>	
SSM relay function	Error present
SSM relay forced control	Normal
SBM relay function	Motor running
Binary input (DI 1)	Active (with cable bridge)
Analog input (AI1), signal type	0 – 10 V
Analog input (AI1), pressure sensor range	10 bar
Analog input (AI2)	Not configured
Wilo Net termination	Switched on
Wilo Net address	Single pump: 126
<b>Double pump operation</b>	
Connecting double pump	Single pump: not connected
Pump cycling	Switched on
Time-based pump cycling	24h
<b>Display setting</b>	
Brightness	80%
Language	German
Units	m, m <sup>3</sup> /h
<b>Additional settings</b>	
Pump kick	Switched on
Pump kick time interval	24h
Pump kick speed	2300/min.
Ramp up time	0 s
Ramp down time	0 s
Automatic PWM frequency	Switched off
Fluid correction	Switched off

Table 19: Factory setting

## 17 Faults, causes and remedies



### WARNING

Have faults remedied by qualified personnel only! Observe safety instructions.

In case of faults, the fault management still provides realistic pump output and functionalities.

A fault is checked without interrupting operation, if mechanically possible. An emergency operation or control mode is established if required. The fault-free pump operation is resumed when the cause of the fault is no longer present.

Example: The electronic module is again cooled down.



## NOTICE

If the pump behaves incorrectly, check that the analogue and digital inputs are configured correctly.

For details, see the detailed instructions at [www.wilo.com](http://www.wilo.com)

**If the malfunction cannot be rectified, consult a specialist technician or the nearest Wilo customer service or representative location.**

### 17.1 Mechanical faults without error messages

Faults	Causes	Remedies
Pump does not start or stops working	Cable terminal loose	Electrical fuse defective
Pump does not start or stops working	Electrical fuse defective	Check fuses; replace faulty fuses
Pump makes noises	Motor has bearing damage	Have the pump checked by Wilo customer service or a specialised service centre and repaired if necessary

Table 20: Mechanical faults

### 17.2 Error messages

#### Displays an error message on the display

- The status display will be in red colour.
- Error message, error code (E...).

The pump does not pump if an error has occurred. If the pump identifies as part of permanent monitoring that the cause of the error no longer applies, the error message is revoked and operation resumes.



## NOTICE

The pump also performs an error check when the external OFF signal is present. An error check may require an attempt to start the motor.

If an error message is output, the display is permanently on and the green LED indicator is off.

Code	Fault	Cause	Remedy
401	Unstable power supply.	Unstable power supply.	Check the electrical installation.
	Additional information about causes and remedy:		
402	Undervoltage	Power supply is too low.	Check the electrical installation.
	Additional information about causes and remedy:		
	Operation cannot be continued. Possible causes:		
403	Overtoltage	Power supply is too high.	Check the electrical installation.
	Additional information about causes and remedy:		
	Operation cannot be continued. Possible causes:		

Code	Fault	Cause	Remedy
404	Pump blocked.	Mechanical influence is inhibiting the rotation of the pump shaft.	Check free movement of rotating parts in the pump head and motor. Remove deposits and foreign substances.
	Additional information about causes and remedy: <ul style="list-style-type: none"> <li>In addition to deposits and foreign substances in the system, the pump shaft can also be blocked by severe bearing wear.</li> </ul>		
405	Electronic module too hot.	Critical temperature of the electronic module exceeded.	Ensure permissible ambient temperature. Improve room ventilation.
	Additional information about causes and remedy: <ul style="list-style-type: none"> <li>To ensure sufficient aeration, adhere to permissible installation position and minimum distance from insulation and system components.</li> </ul>		
406	Motor too hot.	Permissible motor temperature is exceeded.	Ensure permissible ambient and fluid temperature. Ensure motor cooling through free air circulation.
	Additional information about causes and remedy: <ul style="list-style-type: none"> <li>To ensure sufficient aeration, adhere to permissible installation position and minimum distance from insulation and system components.</li> </ul>		
407	Connection between motor and module interrupted.	Electrical connection between motor and module faulty.	Electrical connection between motor and module faulty.
	Check the motor module connection. <ul style="list-style-type: none"> <li>Dismantle the control module to check the contacts between module and motor.</li> </ul>		
408	There is flow through the pump in the opposite direction of flow.	External influences cause flow against the direction of the pump's flow.	Check power control of the pumps, install check valve if needed.
	Additional information about causes and remedy: <ul style="list-style-type: none"> <li>If flow passing through pump in the opposite direction is too strong, the motor can no longer start.</li> </ul>		
409	Incomplete software update.	The software update was not completed.	Software update with a new software bundle is required.
	Additional information about causes and remedy: <ul style="list-style-type: none"> <li>The pump can work only when software update is completed.</li> </ul>		
410	Voltage analogue input overloaded.	Voltage analogue input short-circuited or too heavily loaded.	Check the cables and consumers connected to the analogue input power supply for short circuits.
	Additional information about causes and remedy: <ul style="list-style-type: none"> <li>The fault impairs the binary inputs. EXT. OFF is set. The pump is stationary.</li> </ul>		
411	No mains phase.	No mains phase.	Check the electrical installation.
	Additional information about causes and remedy: <ul style="list-style-type: none"> <li>Contact error on mains connection terminal.</li> <li>Fuse of a mains phase has tripped.</li> </ul>		
412	Dry run	The pump has detected power consumption that is too low.	No fluid in installation. Check water pressure, valves and swing check valves.
	Additional information about causes and remedy: <ul style="list-style-type: none"> <li>The pump is not conveying any fluid or only very little.</li> </ul>		
413	Discharge pressure too high.	Pressure on discharge side is too high.	Check and adjust if needed setting of Max. pressure detection.
	Additional information about causes and remedy: <ul style="list-style-type: none"> <li>Suction pressure on the installation is too high. It must be limited by a pressure limiter.</li> </ul>		

Code	Fault	Cause	Remedy
414	Discharge pressure too low.	Discharge pressure too low.	Check the pipe system installation.  Check and adjust if needed setting of Min. pressure detection.
	Additional information about causes and remedy: <ul style="list-style-type: none"> <li>The pump is delivered high flow and can't reach minimum pressure due to a leakage on the installation.</li> </ul>		
415	Suction pressure too low.	Pressure on suction side too low.	Check if the pressure network is sufficient.  Check and adjust if needed setting of limit for lack of water detection by sensor.  Check and adjust if needed setting of pressure sensor type (absolute or relative).
	Additional information about causes and remedy: Pressure on suction side is too low due to: <ul style="list-style-type: none"> <li>high flow on delivery side and:               <ul style="list-style-type: none"> <li>a too small pipe on suction side,</li> <li>with a lot of elbow on suction side</li> </ul> </li> <li>water level in well is too low.</li> </ul>		
416	Lack of water.	Water shortage on the suction side.	Check water level in tank.  Check functionality of level switch.
417	Hydraulic overload.	The pump has detected an overload on the hydraulic side.	If the liquid is something other than water, the setting for liquid mixture correction needs to be checked and, if necessary, needs to be adjusted.  Check the hydraulic components of the pump.
420	Motor or electronic module defective.	Motor or electronic module defective.	Replace motor and/or electronic module.
	Additional information about causes and remedy: <ul style="list-style-type: none"> <li>The pump cannot determine which of the two component is defective. Contact service.</li> </ul>		
421	Electronic module is defective.	Electronic module is defective.	Replace electronic module.
	Additional information about causes and remedy: <ul style="list-style-type: none"> <li>Contact service.</li> </ul>		

Table 21: Error message

### 17.3 Warning messages

#### Displays a warning on the display

- The status display is marked in yellow.
- Warning message, warning code (W...).

Warnings indicate restricted pump function.

The pump continues to operate in restricted mode (emergency operation). Depending on the cause of the warning, emergency operation may result in a restriction of the control function, up to and including a return to a fixed speed.

If the pump identifies as part of permanent monitoring that the cause of the warning no longer applies, the warning message is revoked and operation resumes.

If there is a warning message, the display is permanently on and the green LED indicator is off.

Code	Warning	Cause	Remedy
550	There is flow through the pump in the opposite direction of flow.	External influences cause flow against the direction of the pump's flow.	Check power control of the pumps, install check valve if needed.
	Additional information about causes and remedy: <ul style="list-style-type: none"> <li>If flow passing through pump in the opposite direction is too strong, the motor can no longer start.</li> </ul>		
551	Undervoltage	Power supply is too low.	Check the electrical installation.
	Additional information about causes and remedy: <ul style="list-style-type: none"> <li>The pump is running. Undervoltage reduces the performance of the pump. If the voltage falls below 324 V, the reduced operation cannot be maintained.</li> </ul>		
552	There is externally generated flow through the pump in the direction of flow.	External influences cause flow in the pump's direction of flow.	Check power control of the other pumps.
	Additional information about causes and remedy: <p>Operation cannot be continued. Possible causes:</p> <ul style="list-style-type: none"> <li>The pump can still start.</li> </ul>		
553	Electronic module is defective.	Electronic module is defective.	Replace electronic module.
	Additional information about causes and remedy: <ul style="list-style-type: none"> <li>The pump is running, but cannot provide full power under the circumstances. Contact service.</li> </ul>		
556	Cable break at analogue input AI1.	The configuration and the present signal help identify the cable break.	Check configuration of the input and connected sensor.
	Additional information about causes and remedy: <ul style="list-style-type: none"> <li>Cable break detection may lead to substitute operation modes, which ensure functioning of the pump without the required external value.</li> </ul>		
558	Cable break at analogue input AI2.	The configuration and the present signal help identify the cable break.	Check configuration of the input and connected sensor.
	Additional information about causes and remedy: <ul style="list-style-type: none"> <li>Cable break detection may lead to substitute operation modes, which ensure functioning of the pump without the required external value.</li> <li>Double pump: <p>If W556 appears in the partner pump display without a differential pressure sensor connected, always check the double pump connection as well. W571 may also be activated, but it is not displayed with the same priority as W556. The partner pump without a connected differential pressure sensor interprets itself as a single pump due to the missing connection to the main pump. In this case, it recognises the unconnected differential pressure sensor as a cable break.</p> </li> </ul>		
560	Incomplete software update.	The software update was not completed.	Software update with new software bundle is recommended.
	Additional information about causes and remedy: <ul style="list-style-type: none"> <li>Software update was not carried out; pump continues to operate with previous software version.</li> </ul>		
561	Voltage analogue input overloaded (binary).	Voltage analogue input short-circuited or too heavily loaded.	Check the cables and consumers connected to the analogue input power supply for short circuits.
	Additional information about causes and remedy: <ul style="list-style-type: none"> <li>Binary inputs are impaired. Functions of binary inputs are not available.</li> </ul>		
562	Voltage analogue input overloaded (analogue).	Voltage analogue input short-circuited or too heavily loaded.	Check the cables and consumers connected to the analogue input power supply for short circuits.
	Additional information about causes and remedy: <ul style="list-style-type: none"> <li>Functions of the analogue inputs are impaired.</li> </ul>		

Code	Warning	Cause	Remedy
564	Setpoint missing from BMS <sup>1</sup> .	Sensor source or BMS <sup>1</sup> is wrongly configured. Communication has failed.	Check configuration and Function of BMS <sup>1</sup> .
	Additional information about causes and remedy: <ul style="list-style-type: none"> <li>Control functions are impaired. A replacement function is active.</li> </ul>		
565	Signal too high at analogue input AI 1.	The available signal is significantly over the expected maximum.	Check input signal.
	Additional information about causes and remedy: <ul style="list-style-type: none"> <li>The signal is processed with the maximum value.</li> </ul>		
566	Signal too high at analogue input AI 2.	The available signal is significantly over the expected maximum.	Check input signal.
	Additional information about causes and remedy: <ul style="list-style-type: none"> <li>The signal is processed with the maximum value.</li> </ul>		
570	Electronic module too hot.	Critical temperature of the electronic module exceeded.	Ensure permissible ambient temperature. Improve room ventilation.
	Additional information about causes and remedy: <ul style="list-style-type: none"> <li>The electronic module must adjust the pump's operation in the event of noticeable overheating to prevent damage to electronic components.</li> </ul>		
571	Double pump connection interrupted.	The connection to the double pump partner cannot be made.	Check power supply of the double pump partner, cable connection and configuration.
	Additional information about causes and remedy: <ul style="list-style-type: none"> <li>The pump function is slightly impaired. The motor head meets the pump function up to the performance limit.</li> </ul> See also additional information Code 582.		
573	Communication to display and operating unit interrupted.	Internal communication to display and operating unit interrupted.	Check the ribbon cable connection.
	Additional information about causes and remedy: <ul style="list-style-type: none"> <li>The display and operating unit is connected to the pump's electronic unit via a ribbon cable on its rear.</li> </ul>		
574	Communication to CIF module interrupted.	Internal communication to the CIF module interrupted.	Check/clean contacts between CIF module and electronic module.
	Additional information about causes and remedy: <ul style="list-style-type: none"> <li>The CIF module is connected in the terminal room to the pump via 4 contacts.</li> </ul>		
578	Display and control unit defective.	A fault in the display and operating unit has been identified.	Replace display and operating unit.
	Additional information about causes and remedy: <ul style="list-style-type: none"> <li>The display and operating unit is available as a spare part.</li> </ul>		
582	Double pump is not compatible.	Double pump partner is not compatible with this pump.	Select/install appropriate double pump partner.
	Additional information about causes and remedy: <ul style="list-style-type: none"> <li>Double pump function is only possible with two compatible pumps of the same type.</li> </ul>		
586	Overvoltage	Power supply is too high.	Check power supply
	Additional information about causes and remedy: <ul style="list-style-type: none"> <li>The pump is running. If the voltage continues to rise, the pump will shut down. Excessive voltages can damage the pump.</li> </ul>		

Code	Warning	Cause	Remedy
588	Electronics fan blocked, defective or not connected.	Electronics fan not working	Check fan cable

Table 22: Warning messages

<sup>1)</sup> BMS = Building management system

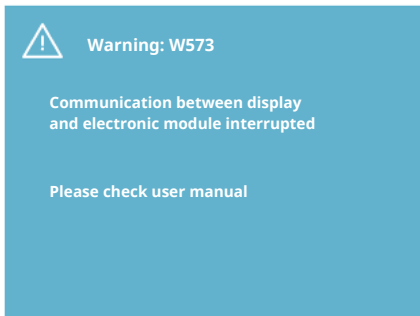

Fig. 44: Warning



## NOTICE

The warning W573 “Communication to the display and control unit interrupted”, is shown differently from all other warnings on the display. The following Screen is show on the Display:

## 18 Maintenance

### Safety carried out by qualified personnel only!



## DANGER

### Danger of death!

**There is danger of death from electric shock when working on electrical devices.**

Work on electrical devices may only be carried out by electricians approved by the local electricity supplier.

Before working on electrical devices, switch them off so that they are voltage-free and secure against reactivation.

Any damage to the pump connection cable should only ever be rectified by a qualified electrician.

Never use an object to poke around the openings on the electronic module or motor and never insert anything into the module or motor.

Follow the installation and operating instructions for the pump, level control device and other accessories!



## DANGER

### Danger of death!

**The permanently magnetised rotor inside the motor presents an acute danger to persons with pacemakers. Non-observance results in death or the most serious of injuries.**

Persons with pacemakers must follow the general behavioural guidelines that apply for handling electrical equipment when working on the pump!

Do not open the motor!

Only allow Wilo customer service to dismantle and install the rotor for maintenance and repair work!

Only allow persons who do not have a pacemaker to dismantle and install the rotor for maintenance and repair work.



## NOTICE

The magnets inside the motor do not pose a danger provided the motor is completely assembled. As such, the pump assembly does not pose a special danger to persons with pacemakers. They can safely approach the drive without any restrictions.





## WARNING

### Risk of personal injury!

**Opening the motor leads to high, suddenly occurring magnetic forces. These can cause serious cuts, crushing injuries and bruises.**

Do not open the motor!

Only allow Wilo customer service to dismantle and install the motor flange and the bearing plate for maintenance and repair work!



## DANGER

### Danger of death!

**Failure to install safety devices on the electronic module or near the coupling can cause electric shock or contact with rotating parts, potentially resulting in life-threatening injuries.**

After maintenance, all safety devices such as module covers or coupling covers that were removed must be reinstalled!



## CAUTION

### Risk of property damage!

**Risk of damage due to incorrect handling.**

The drive may never be operated without the electronic module being installed.



## DANGER

### Danger of death!

**The drive itself and drive parts can be extremely heavy. Falling parts pose a risk of cuts, crush injuries, bruises or impacts, which can be fatal.**

Always use suitable lifting accessories and secure parts against falling. Never stand below a suspended load.

Make sure the drive is securely positioned and is stable during storage and transport as well as prior to all installation and other assembly work.



## DANGER

### Danger of death!

**The tools used during maintenance work on the motor shaft can be flung out if they come into contact with rotating parts, and cause serious or even fatal injuries.**

The tools used during maintenance work must be removed completely before the drive is started up.

If the transport lugs are moved from the motor flange to the motor housing, they must be resecured to the motor flange following the installation or maintenance work.

### Air supply

After completion of all maintenance work, reattach the fan cover with the screws provided so that the motor and the electronic module are sufficiently cooled.

The air supply to the motor housing and module must be checked at regular intervals. In case of contamination, ensure that an air supply is re-established in order to allow the motor and electronic module to cool sufficiently.

**DANGER****Danger of death!**

**There is danger of death from electric shock when working on electrical devices. Following removal of the electronic module, a potentially fatal shock voltage may be present at the motor contacts.**  
Check for absence of voltage and cover or cordon off adjacent live parts. Close the shut-off devices upstream and downstream of the pump.

**DANGER****Danger of death!**

**Falling drive or drive parts may result in life-threatening injuries.**  
When performing installation work, protect the drive components against falling.

**18.1 Replacing the electronic module****NOTICE**

The magnets inside the motor pose no risk to persons with pacemakers provided that the motor is not opened and the rotor is not removed. The electronic module can be replaced without any risk.

**DANGER****Danger of death!**

**If the rotor is driven by the impeller when the pump is at a standstill, dangerous contact voltage can arise at the motor contacts.**  
Close the shut-off devices upstream and downstream of the pump.

- Carry out this steps to dismantle the electronic module.
- Remove the 4 screws (Fig. 1 rep. 4) and pull the electronic module (Fig. 1 rep. 1) off the motor.
- Replace O-ring (fig. 1 rep. 13).
- Before reinstalling the electronic module, pull the new O-ring between the electronic module and the motor adapter (fig. 1 rep. 6) onto the contacting chamber.
- Press the electronic module into the motor contacting and fasten with screws.
- Proceed further (restore pump to operational standby).

**NOTICE**

The electronic module must be pressed on as far as possible when it is installed.

**NOTICE**

Observe the commissioning measures, section 9 Commissioning.

**NOTICE**

Disconnect the electronic module from the mains supply when performing another insulation test on site!

**NOTICE**

Before ordering a replacement electronic module to be used in the double pump operation, ensure that you have checked the software version used on the remaining double pump partner!

The software used for both double pump partners must be compatible. Contact Wilo-Service.

**18.2 Replacing the motor/drive****NOTICE**

The magnets inside the motor pose no risk to persons with pacemakers provided that the motor is not opened and the rotor is not removed. The motor/drive can be replaced without any risk.

- Carry out this steps to dismantle the motor on Helix2.0 range.
- Remove the inverter as described in Chapter 19.1
- Remove the 4 screws (Fig. 1, rep. 5) and pull the motor (Fig. 1, rep. 8) vertically upwards.
- Before reinstalling the new motor, align the motor key shaft (Fig. 1, rep. 11) with the lantern (fig. 1, rep. 12).
- Press the new motor into the lantern and fasten with screws.

**NOTICE**

The motor must be pressed on as far as possible when it is installed.

**DANGER****Danger of death!**

**There is danger of death from electric shock when working on electrical devices. Following removal of the electronic module, a potentially fatal shock voltage may be present at the motor contacts.**

Ensure system is voltage-free, cover or screen off adjacent live parts. Close the shut-off devices upstream and downstream of the pump.

**NOTICE**

Increased bearing noises and unusual vibrations indicate bearing wear. Then the bearing has to be changed by Wilo customer service.

**WARNING****Risk of personal injury!**

**Opening the motor leads to high, suddenly occurring magnetic forces. These can cause serious cuts, crushing injuries and bruises.**

Do not open the motor!

Only allow Wilo customer service to dismantle and install the motor flange and the bearing plate for maintenance and repair work!

**18.3 Module fan replacement**

To dismantle the module, see "Replacing the electronic module" section.

- Open the cover of the electronic module. (Fig. 45).
- Remove the connection cable of the module fan. (Fig. 46).
- Loosen the screws of the fan (Fig. 47).
- Remove the fan and release the cable with the rubber sealing from the lower part of the module (Fig. 48).

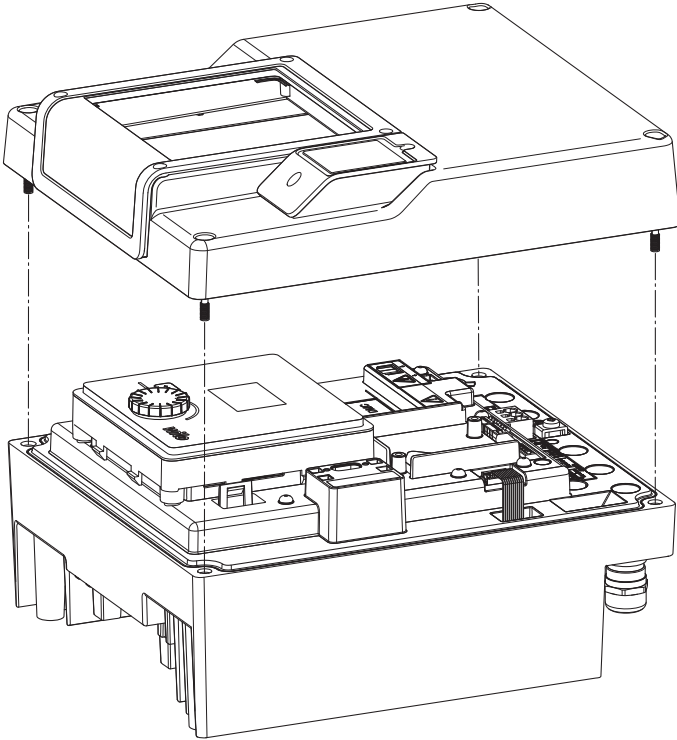

Fig. 45: Open the cover of the electronic module

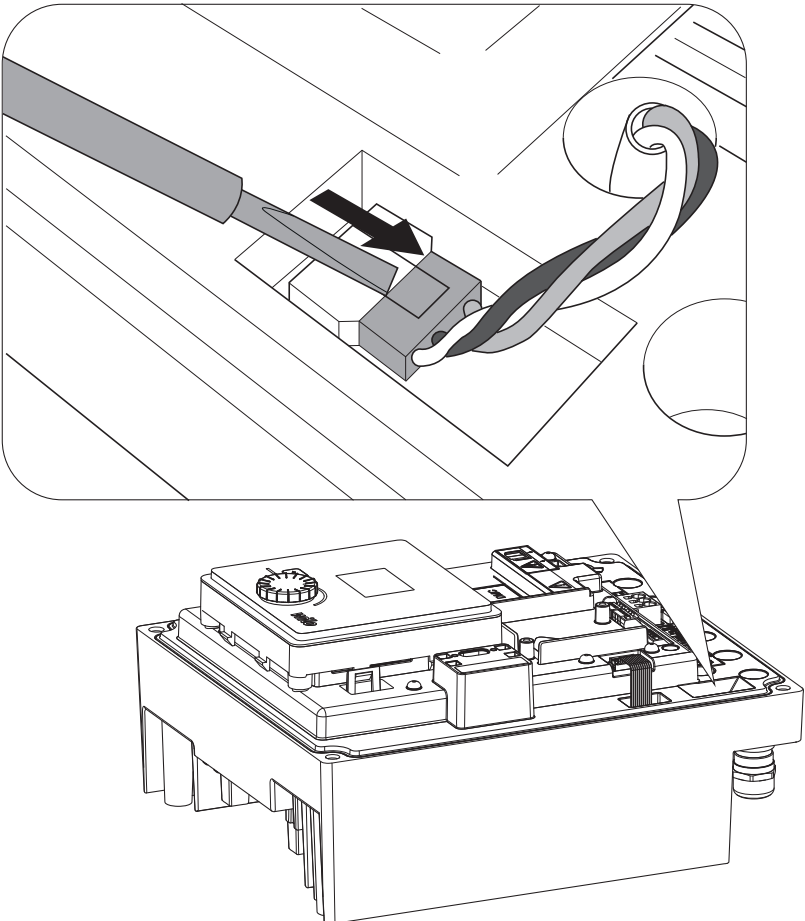

Fig. 46: Detach the module fan connection cable

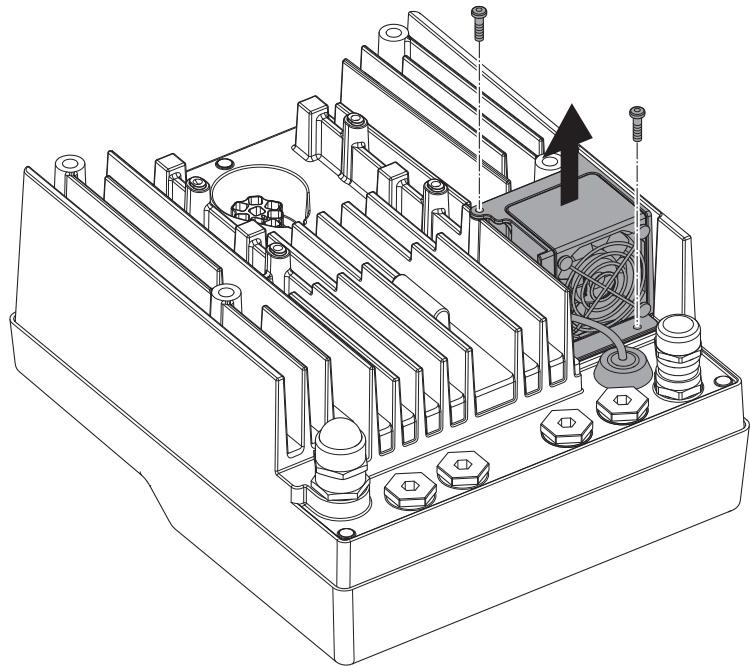

Fig. 47: Disassembly of the module fan

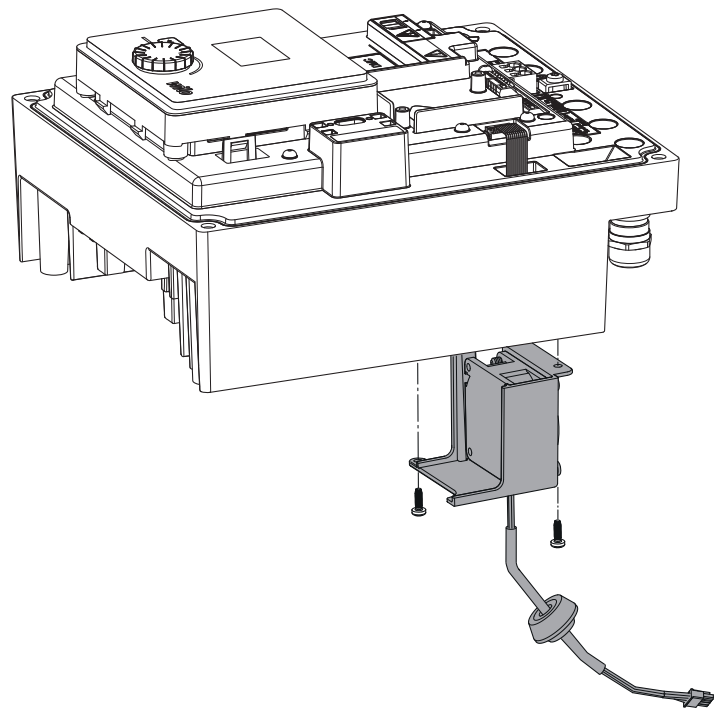

Fig. 48: Remove the module fan incl. cable and rubber sealing

#### Mounting the fan

Install the module fan in reverse order.

## 19 Spare parts

Obtain genuine spare parts only from a qualified specialist or Wilo customer service. To avoid queries and order errors, please provide all drive rating plate data with every order. Drive type rating plate (Fig. 3, Item 2).



## WARNING

### Risk of property damage!

Trouble-free pump operation can only be guaranteed when original spare parts are used.

Use only original Wilo spare parts!

Information to be provided when ordering spare parts: Spare part numbers, spare part designations, all data of the drive rating plate. This helps prevent return queries and incorrect orders.



## NOTICE

For a list of genuine spare parts, see the Wilo spare parts documentation ([www.wilo.com](http://www.wilo.com)). The item numbers on the exploded view drawing (Fig. 1 and Fig. 2) are intended as orientation and to provide a list of the drive components. These item numbers are not to be used to order spare parts!

## 20 Disposal

### Information on the collection of used electrical and electronic products.

Proper disposal and appropriate recycling of this product avoids damage to the environment and risks to personal health.



## NOTICE

### Disposal in domestic waste is prohibited!

In the European Union, this symbol can appear on the product, the packaging or the accompanying documentation. It means that the electrical and electronic products in question must not be disposed of along with domestic waste.

Please note the following points to ensure proper handling, recycling and disposal of the used products in question:

- Hand over these products at designated, certified collection points only.
- Observe the locally applicable regulations!

Please consult your local municipality, the nearest waste disposal site, or the dealer who sold the product to you for information on proper disposal. Further recycling information at [www.wilorecycling.com](http://www.wilorecycling.com).



# wilo



Local contact at  
[www.wilo.com/contact](http://www.wilo.com/contact)

Pioneering for You

WILO SE  
Wilopark 1  
44263 Dortmund  
Germany  
T +49 (0)231 4102-0  
T +49 (0)231 4102-7363  
[wilo@wilo.com](mailto:wilo@wilo.com)  
[www.wilo.com](http://www.wilo.com)