

TECHNICAL DATA SHEET

DucoVent Design AK

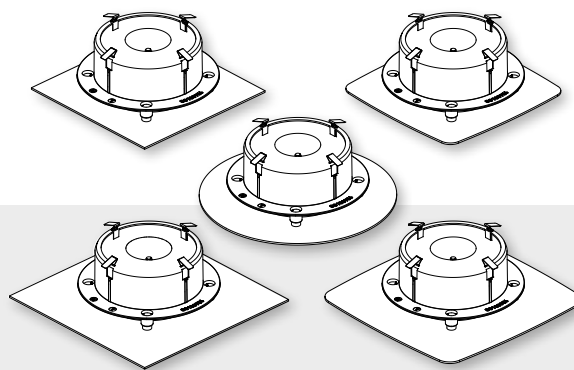

An aesthetic vent, available with **five different cover plates**: square (standard and XL), rounded square (standard and XL) or round. The **sleek design**, combined with **simple installation** thanks to the magnetic strips used, ensures **virtually invisible integration** into any room where air extraction or supply is provided.

Physical characteristics

	Square Standard	Square XL	Round	Rounded Square Standard	Rounded Square XL
Item number	4179	4226	4210	4211	4227
Suitable for	Extraction	Extraction / Supply	Extraction / Supply	Extraction	Extraction / Supply
Weight	362 g	419 g	381 g	356 g	413 g
Material	Steel Plastic PVC Aluminium (Al Mg Si 0.5) D100 Flaked foam				
Colour	White (RAL 9010 structure (AE03059901020)) Other RAL colours upon request				
Surface treatment	Enamelled				
Fitting / setting-up method	Suitable for ceiling and wall 180 cm min. above the floor 35 cm min. from the wall				
Connection	With clamping springs, suitable for 125 mm diameter ducts				
Calibration	Pre-adjustment: by means of acoustic rings Fine adjustment: continuous by means of a spindle				
Maximum flow rate	Extraction: 75 m ³ /h Supply: 50 m ³ /h				
Back pressure	Extraction: 25 m ³ /h → 35 Pa 50 m ³ /h → 40 Pa 75 m ³ /h → 35 Pa Supply: 25 m ³ /h → 20 Pa 50 m ³ /h → 23 Pa				
Sound deadening	Yes				
Noise level	Extraction: < 15 dB(A) at 50 m ³ /h Supply: to be established				

Square

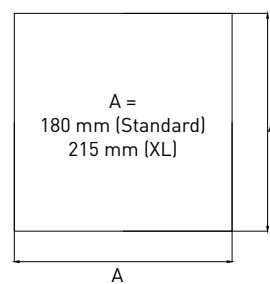

Round

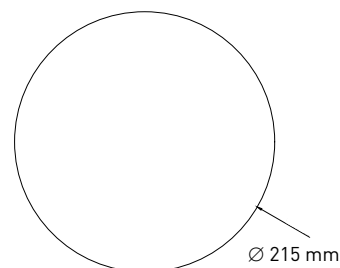

Rounded Square

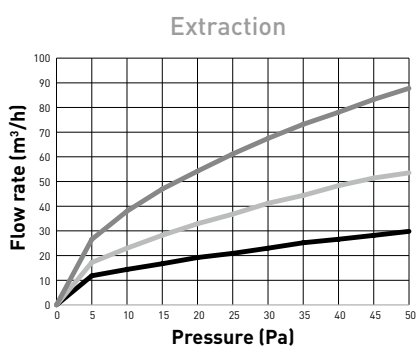
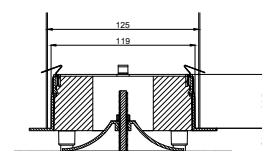
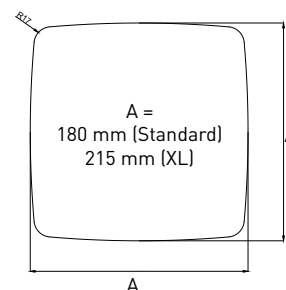

- Flow rate with 1 ring
- Flow rate with 2 rings
- Flow rate with 3 rings

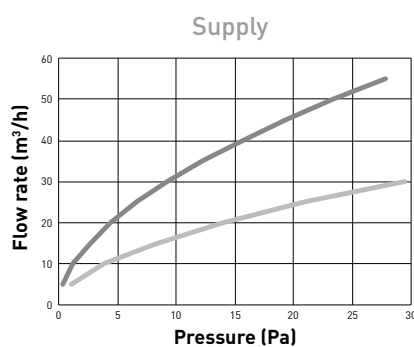

- Flow rate with 1 ring
- Flow rate with 2 rings