

Data Sheet | Item Number: 745-602/006-000

PCB terminal block; 16 mm²; Pin spacing 15 mm; 2-pole; CAGE CLAMP®; commo-
ning option; gray

<https://www.wago.com/745-602/006-000>



Color: ■ gray

Similar to illustration

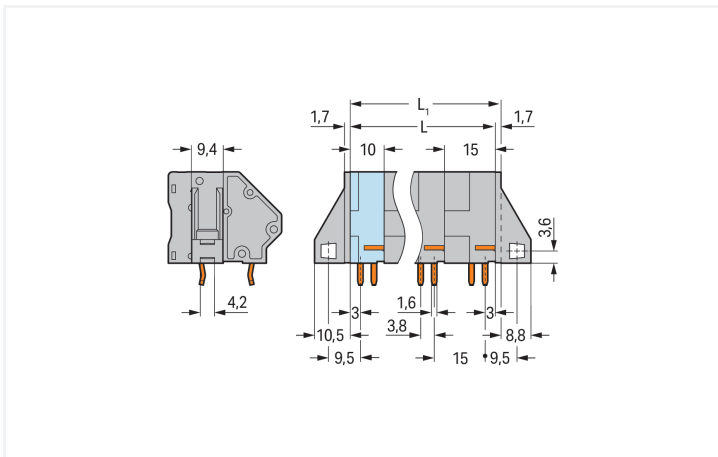
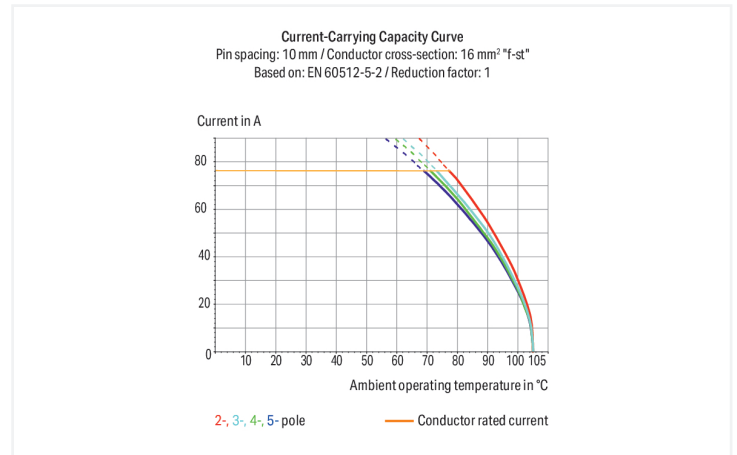

Dimensions in mm

$L = (\text{pole no.} - 1) \times \text{pin spacing} + 10 \text{ mm}$
 $L_1 = L + 1.7 \text{ mm} \triangleq \text{version without mounting flange}$

PCB terminal block, 745 Series, with 15 mm pin spacing

Quick and easy connections are guaranteed with this PCB terminal block (item number 745-602/006-000). It is ideal for custom installations with different mounting types. Strip lengths must be between 12 and 13 mm when connecting conductors to this PCB terminal block. Featuring one conductor terminal along with CAGE CLAMP®, this connector is highly versatile. Our trusted universal connection known as CAGE CLAMP® is the industry standard for connection technology and electrical interconnections. Dimensions: (26.7 x 33.5 x 33.4) mm (width x height x depth). Depending on the type of conductor, this PCB terminal block is designed for conductor cross sections ranging from 0.2 mm² to 16 mm².

Tin is used for coating the contact surfaces. This PCB terminal block is operated with an operating tool. The PCB terminal block is designed for THT soldering. The conductor is designed to be inserted into the board at an angle of 45°.

Notes

Variants: Other pole numbers Versions for Ex e II and Ex i Versions for Ex i Other colors Mixed-color PCB connector strips Versions with mounting flanges Direct marking Solder pin length: 5 mm Other versions (or variants) can be requested from WAGO Sales or configured at https://configurator.wago.com/ .

Electrical data

IEC/EN 60664-1	Approvals per UL 1059						
Ratings per	III	II	I	Use group	B	C	D
Overvoltage category	III	II	I	Use group	B	C	D
Pollution degree	3	2	2	Rated voltage	300 V	300 V	600 V
Nominal voltage	630 V	1000 V	1000 V	Rated current	65 A	65 A	5 A
Rated impulse withstand voltage	8 kV	8 kV	8 kV				
Rated current	76 A	76 A	76 A				

CSA	Approvals per		
Use group	B	C	D
Use group	B	C	D
Rated voltage	300 V	300 V	600 V
Rated current	65 A	65 A	5 A

Connection Data

Connection 1	
Clamping units	2
Total number of potentials	2
Number of connection types	1
Number of levels	1
Number of jumper slots	1
Connection technology	CAGE CLAMP®
Actuation type	Operating tool
Solid conductor	0.2 ... 16 mm² / 24 ... 6 AWG
Fine-stranded conductor	0.2 ... 16 mm² / 24 ... 6 AWG
Fine-stranded conductor; with insulated ferrule	0.25 ... 10 mm²
Fine-stranded conductor; with uninsulated ferrule	0.25 ... 10 mm²
Strip length	12 ... 13 mm / 0.47 ... 0.51 inches
Conductor connection direction to PCB	45°
Pole number	2

Physical data

Pin spacing	15 mm / 0.591 inches
Width	26.7 mm / 1.051 inches
Height	33.5 mm / 1.319 inches
Height from the surface	27 mm / 1.063 inches
Depth	33.4 mm / 1.315 inches
Solder pin length	6.5 mm
Solder pin dimensions	1.2 x 1.6 mm
!	2.2 ^(+0.1) mm

PCB contact

PCB contact	THT
Solder pin arrangement	over the entire terminal strip (in-line)
Number of solder pins per potential	4

Material data

Note (material data)	Information on material specifications can be found here
Color	gray
Material group	I
Insulation material (main housing)	Polyamide (PA66)
Flammability class per UL94	V0
Clamping spring material	Chrome-nickel spring steel (CrNi)
Contact material	Electrolytic copper (E _{cu})
Contact Plating	Tin
Fire load	0.344 MJ
Weight	20.9 g

Environmental requirements

Limit temperature range	-60 ... +105 °C
-------------------------	-----------------

Commercial data

Product Group	4 (Printed Circuit Connectors)
PU (SPU)	36 pcs
Packaging type	Box
Country of origin	PL
GTIN	4044918302951
Customs tariff number	85369010000

Product Classification

UNSPSC	39121409
eCl@ss 10.0	27-44-04-01
eCl@ss 9.0	27-44-04-01
ETIM 9.0	EC002643
ETIM 10.0	EC002643
ECCN	NO US CLASSIFICATION

Environmental Product Compliance

RoHS Compliance Status	Compliant, No Exemption
------------------------	-------------------------

Approvals / Certificates

General approvals



General approvals

UR	UL 1059	E45172
Underwriters Laboratories Inc.		

Approval	Standard	Certificate Name
CCA DEKRA Certification B.V.	EN 60947	2160584.14
CCA DEKRA Certification B.V.	EN 60947	NTR NL-7094
CSA DEKRA Certification B.V.	C22.2 No. 158	1604421

Declarations of conformity and manufacturer's declarations

Approval	Standard	Certificate Name
EU-Declaration of Confor- mity WAGO GmbH & Co. KG	-	-
UK-Declaration of Confor- mity WAGO GmbH & Co. KG	-	-

Downloads

Environmental Product Compliance

Compliance Search

Environmental Product Compliance 745-602/006-000	↓
--------------------------------------------------------	---

Documentation

Additional Information

Technical Section	03.04.2019	pdf 2027.26 KB	↓
-------------------	------------	-------------------	---

CAD/CAE-Data

CAD data

2D/3D Models 745-602/006-000	↓
---------------------------------	---

CAE data

EPLAN Data Portal 745-602/006-000	↓
ZUKEN Portal 745-602/006-000	↓

PCB Design















Symbol and Footprint via SamacSys 745-602/006-000	↓
Symbol and Footprint via Ultra Librarian 745-602/006-000	↓

1 Compatible Products

1.1 Optional Accessories















1.1.1 Ferrule

1.1.1.1 Ferrule

 Item No.: 216-262 Ferrule; Sleeve for 0.75 mm ² / 18 AWG; insulated; electro-tin plated; electrolytic copper; gastight crimped; acc. to DIN 46228, Part 4/09.90; gray	 Item No.: 216-263 Ferrule; Sleeve for 1 mm ² / AWG 18; insulated; electro-tin plated; electrolytic copper; gastight crimped; acc. to DIN 46228, Part 4/09.90; red	 Item No.: 216-264 Ferrule; Sleeve for 1.5 mm ² / AWG 16; insulated; electro-tin plated; electrolytic copper; gastight crimped; acc. to DIN 46228, Part 4/09.90; black	 Item No.: 216-284 Ferrule; Sleeve for 1.5 mm ² / AWG 16; insulated; electro-tin plated; electrolytic copper; gastight crimped; acc. to DIN 46228, Part 4/09.90; black
 Item No.: 216-289 Ferrule; Sleeve for 10 mm ² / AWG 8; insulated; electro-tin plated; electrolytic copper; gastight crimped; acc. to DIN 46228, Part 4/09.90; red	 Item No.: 216-209 Ferrule; Sleeve for 10 mm ² / AWG 8; insulated; electro-tin plated; red	 Item No.: 216-109 Ferrule; Sleeve for 10 mm ² / AWG 8; un-insulated; electro-tin plated	 Item No.: 216-266 Ferrule; Sleeve for 2.5 mm ² / AWG 14; insulated; electro-tin plated; electrolytic copper; gastight crimped; acc. to DIN 46228, Part 4/09.90; blue
 Item No.: 216-286 Ferrule; Sleeve for 2.5 mm ² / AWG 14; insulated; electro-tin plated; electrolytic copper; gastight crimped; acc. to DIN 46228, Part 4/09.90; blue	 Item No.: 216-267 Ferrule; Sleeve for 4 mm ² / AWG 12; insulated; electro-tin plated; electrolytic copper; gastight crimped; acc. to DIN 46228, Part 4/09.90; gray	 Item No.: 216-287 Ferrule; Sleeve for 4 mm ² / AWG 12; insulated; electro-tin plated; electrolytic copper; gastight crimped; acc. to DIN 46228, Part 4/09.90; gray	 Item No.: 216-208 Ferrule; Sleeve for 6 mm ² / AWG 10; insulated; electro-tin plated; electrolytic copper; gastight crimped; acc. to DIN 46228, Part 4/09.90; yellow
 Item No.: 216-288 Ferrule; Sleeve for 6 mm ² / AWG 10; insulated; electro-tin plated; electrolytic copper; gastight crimped; acc. to DIN 46228, Part 4/09.90; yellow	 Item No.: 216-108 Ferrule; Sleeve for 6 mm ² / AWG 10; un-insulated; electro-tin plated; silver-colored		

1.1.2 Marking

1.1.2.1 Marker

 Item No.: 2009-145/000-006 Mini-WSB Inline; for Smart Printer; 1700 pieces on roll; stretchable 5 - 5.2 mm; plain; snap-on type; blue	 Item No.: 2009-145/000-007 Mini-WSB Inline; for Smart Printer; 1700 pieces on roll; stretchable 5 - 5.2 mm; plain; snap-on type; gray	 Item No.: 2009-145/000-023 Mini-WSB Inline; for Smart Printer; 1700 pieces on roll; stretchable 5 - 5.2 mm; plain; snap-on type; green	 Item No.: 2009-145/000-012 Mini-WSB Inline; for Smart Printer; 1700 pieces on roll; stretchable 5 - 5.2 mm; plain; snap-on type; orange
 Item No.: 2009-145/000-005 Mini-WSB Inline; for Smart Printer; 1700 pieces on roll; stretchable 5 - 5.2 mm; plain; snap-on type; red	 Item No.: 2009-145/000-024 Mini-WSB Inline; for Smart Printer; 1700 pieces on roll; stretchable 5 - 5.2 mm; plain; snap-on type; violet	 Item No.: 2009-145 Mini-WSB Inline; for Smart Printer; 1700 pieces on roll; stretchable 5 - 5.2 mm; plain; snap-on type; white	 Item No.: 2009-145/000-002 Mini-WSB Inline; for Smart Printer; 1700 pieces on roll; stretchable 5 - 5.2 mm; plain; snap-on type; yellow
 Item No.: 248-501/000-006 Mini-WSB marking card; as card; not stretchable; plain; snap-on type; blue	 Item No.: 248-501/000-007 Mini-WSB marking card; as card; not stretchable; plain; snap-on type; gray	 Item No.: 248-501/000-012 Mini-WSB marking card; as card; not stretchable; plain; snap-on type; orange	 Item No.: 248-501/000-005 Mini-WSB marking card; as card; not stretchable; plain; snap-on type; red
 Item No.: 248-501 Mini-WSB marking card; as card; not stretchable; plain; snap-on type; white	 Item No.: 248-501/000-002 Mini-WSB marking card; as card; not stretchable; plain; snap-on type; yellow		

1.1.3 Test and measurement

1.1.3.1 Testing accessories



Item No.: 210-136

Test plug; 2 mm Ø; with 500 mm cable; red

1.1.4 Tool

1.1.4.1 Operating tool



Item No.: 210-721

Operating tool; Blade: 5.5 x 0.8 mm; with a partially insulated shaft; multicoloured

Installation Notes

Conductor termination

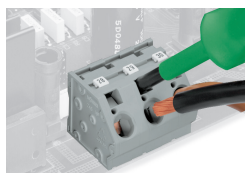

Inserting/removing a conductor via 5.5 mm screwdriver – 745 Series, 16 mm².

Marking

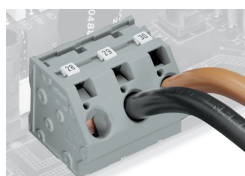

Marking via Mini-WSB and WMB markers or factory direct marking – 745 Series.

Testing

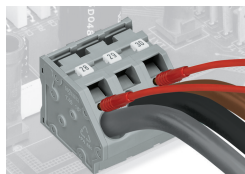

Testing with test plug – 745 Series.

Commoning

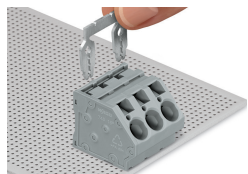

Inserting a comb-style jumper bar.

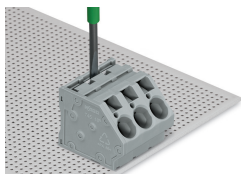

To insert a comb-style jumper bar, push it down using a screwdriver until it hits the backstop – 745 Series.

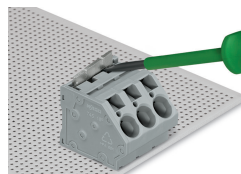

To remove the jumper bar, lift it up using a screwdriver – 745 Series.