





20 004 706 Product version from 3/9/2015

- hole diameter 32 mm
- rosette 60 x 47 mm
- with hot marking
- WRAS



	Brushed Dark Platinum	20 004 706-99
	Chrome	20 004 706-00
	Brushed Platinum	20 004 706-06
	Dark Chrome	20 004 706-19
	Brushed Light Gold (PVD)	20 004 706-27
	Brushed Champagne (22kt Gold)	20 004 706-46
	Champagne (22kt Gold)	20 004 706-47

20 004 706 Product version from 3/9/2015

mm [inches]

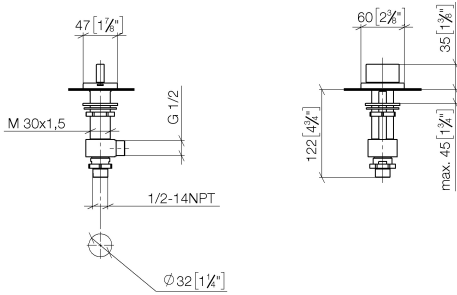

**Flow rate chart**

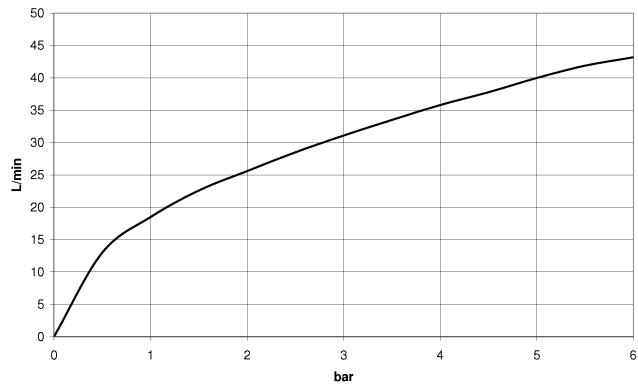

**Codes & Standards**

ASME A112.18.1	cUPC	DIN 4109	ISO 3822
NSF372	NSF61	Scottish Water Byelaws	UK Water Supply Regulations

**Ü-Zeichen**



## CL.1 Deck valve anti-clockwise closing hot - Brushed Dark Platinum

CL.1

20 004 706 Product version from 3/9/2015

### Certificates and sustainability

IAPMO\_N-4

WRAS\_240202

LGA\_28

IAPMO\_4976

IAPMO\_6

EPD-DOR-20230287

-IBA1-EN

Environmental.prod

uct-declarat

20 004 706 Product version from 3/9/2015

Parts for other finishes can be found here: [Chrome](#)

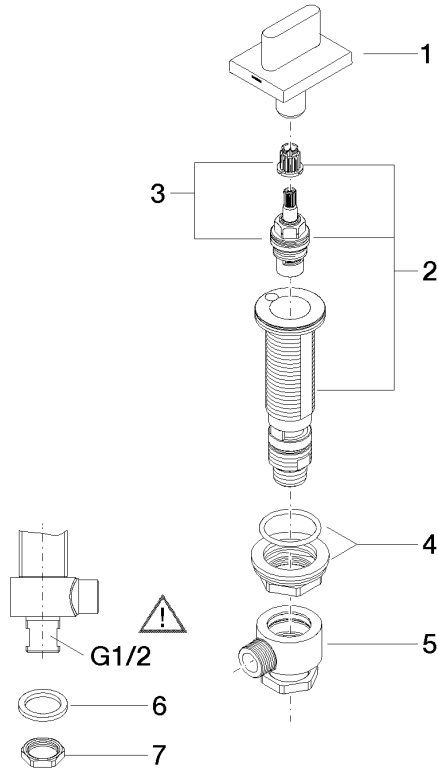

**Spare parts list**

No.	Item Number	Name	Quantity used	Delivery time
7	09 30 11 059 90	Disc -	1.00	14
6	90 23 30 040 00-99	Union piece - Brushed Dark Platinum	1.00	40
1	90 20 70 051 07-99	Handle for basin Hot oval pure 60 x 47,5 x 40 mm - Brushed Dark Platinum	1.00	40
4	04 23 10 032 78 90	Mounting with seals M30 x 1,5 -	1.00	14
8	09 23 10 012 90	Mounting Nut SW 24 1/2" -	1.00	14
3	90 90 03 152 00 90	Head part anti-clockwise closing extended, 7mm 1/2" -	1.00	14
2	04 17 11 058 52 90	Side piece 1/2" -	1.00	14
5	04 17 11 023 10 90	Connection Distributor, complete 1/2" -	1.00	14