



# Acti 9

Low voltage  
The efficiency you deserve



iID residual current circuit breakers .....	4
RCCB-ID 125 A residual current circuit breakers .....	7
iC60N circuit breakers (curves C, D).....	9
iC60H circuit breakers (curve C) .....	10
iC60L circuit breakers (curve C).....	11
Vigi iC60 add-on residual current devices .....	14
Residual current devices iDPN N Vigi and DPN N Vigi .....	18
Electrical auxiliaries for iC60, iID, iDPN Vigi, iSW-NA.....	21
RCA remote controls .....	26
iID K residual current circuit breakers .....	29
iK60N circuit breakers (curve C) .....	31
C120H circuit breakers (curves C, D) .....	33
Vigi C120 add-on residual current devices (type AC).....	36
C60H-DC.....	38
Electrical auxiliaries for C120, C60H-DC, DPN N Vigi .....	41
iPRF1 12.5r/PRD1 25r .....	46
iPRD surge arresters .....	50
iPF K surge arresters .....	54
iPRD-DC surge arresters .....	56
iSW Acti 9 switches.....	59
iSW switches .....	62
iSSW linear switches .....	65
iSW-NA switch-disconnector remote tripping .....	66
STI isolatable fuse-carriers.....	68
SBI fuse holders with indicator light .....	71
iCT contactors .....	73
iTL impulse relays .....	78
Relays iRTA, iRLI, iRCP .....	81
iIL indicator light .....	86
iSO bell .....	87
iTR transformers.....	88
Modular iPC power sockets .....	90
iPB pushbutton .....	91
Horizontal comb busbars .....	92
Linergy DS .....	94
Linergy DX .....	96
Linergy FM.....	97
Accessories for iC60, iID, iDPN Vigi, iSW-NA, iSW Acti 9 .....	98
Accessories for C120, C60H- DC, iSW, DPN N Vigi devices ...	104

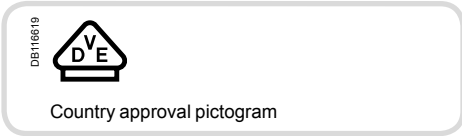

IEC/EN 61008-1

PB 104472-40



PB 104473-40



- The iID residual current circuit breakers provide:
  - protection of persons against electric shock by direct contact (30 mA),
  - protection of persons against electric shock by indirect contact (300 mA),
  - protection of installations against the risk of fire (300 mA).

The *SI* type provides increased immunity from electrical interference and polluted or corrosive environments.

## Catalogue numbers

### iID residual current circuit breakers for 230/400 V network

Type	AC	<i>SI</i>	Width in 9 mm module			
Auxiliaries	See page 21					
<b>2P</b>	<b>Sensitivity</b>	<b>30 mA</b>	<b>300 mA</b>	<b>300 mA </b>	<b>30 mA</b>	
<p>DB12476</p>	Rating	25 A	A9R71225	-	-	4
	40 A	A9R71240	-	-	-	
	63 A	A9R71263	A9R74263	A9R15263	A9R91263	
	80 A	A9R11280	A9R14280	A9R15280	-	
	100 A	A9R11291	A9R14291	A9R15291	-	
<b>4P</b>	<b>Sensitivity</b>	<b>30 mA</b>	<b>300 mA</b>	<b>300 mA </b>		
<p>DB12477</p>	Rating	25 A	A9R71425	-	-	8
	40 A	A9R71440	-	-	-	
	63 A	A9R71463	A9R74463	A9R15463	A9R91463	
	80 A	A9R11480	A9R14480	A9R15480	-	
	100 A	A9R11491	A9R14491	A9R15491	-	
Voltage rating (Ue)	2P	230 - 240 V				
	4P	400 - 415 V				
Operating frequency	50/60 Hz					
Accessories	See page 94					

# iID residual current circuit breakers (AC, A, SI types)

## Connection

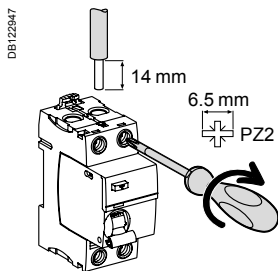

Type	Tightening torque	Without accessory		With accessories*		
		Copper cables Rigid	Copper cables Flexible or with ferrule	50 mm <sup>2</sup> Al terminal	Screw-on connection for ring terminal	Multi-cables terminal Rigid cables
iID	3.5 N.m	1 to 35 mm <sup>2</sup>	1 to 25 mm <sup>2</sup>	50 mm <sup>2</sup>	Ø 5 mm	3 x 16 mm <sup>2</sup> / 3 x 10 mm <sup>2</sup>

\* See module CA907000

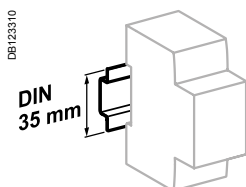

Clip on DIN rail 35 mm.

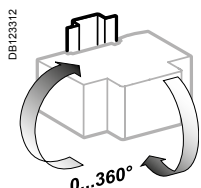

Indifferent position of installation.

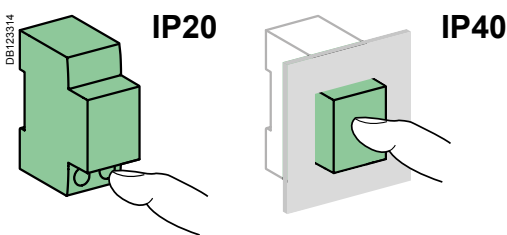

## Technical data

### Main characteristics

Insulation voltage (U <sub>i</sub> )	500 V
Pollution degree	3
Rated impulse withstand voltage (U <sub>imp</sub> )	6 kV

### According to IEC/EN 61008-1

Making and breaking capacity (I <sub>m</sub> /I <sub>Δm</sub> )	1500 A
Surge current withstand (8/20 μs) without tripping	AC types (no selective Ⓢ) 250 Å AC types (selective Ⓢ) 3 kÅ
	SI type 3 kÅ
Conditional rated short circuit current (I <sub>nc</sub> /I <sub>Δc</sub> )	With iC60N/H/L Equal to breaking capacity of iC60 With fuse 10,000 A

Behaviour in case of voltage drop  Residual current protection down to 0 V according to IEC/EN 61008-1 § 3.3.4

### Additional characteristics

Degree of protection	Device only IP20 Device in modular enclosure IP40	Insulation class II
Endurance (O-C)	Electrical (AC1) 16 to 63 A 15,000 cycles 80 to 100 A 10,000 cycles Mechanical 20,000 cycles	
Operating temperature	AC type -5°C to +60°C SI types  -25°C to +60°C	
Storage temperature		-40°C to +85°C

## Weight (g)

Residual current circuit breakers	
Type	iID
2P	210
4P	370

## Dimensions (mm)

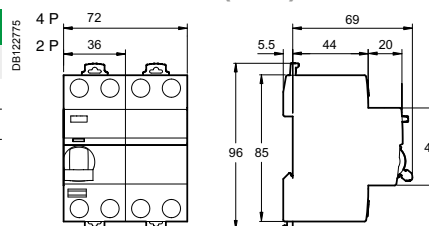

# iLD residual current circuit breakers (AC, A, *SI* types) (cont.)



PB104548-40

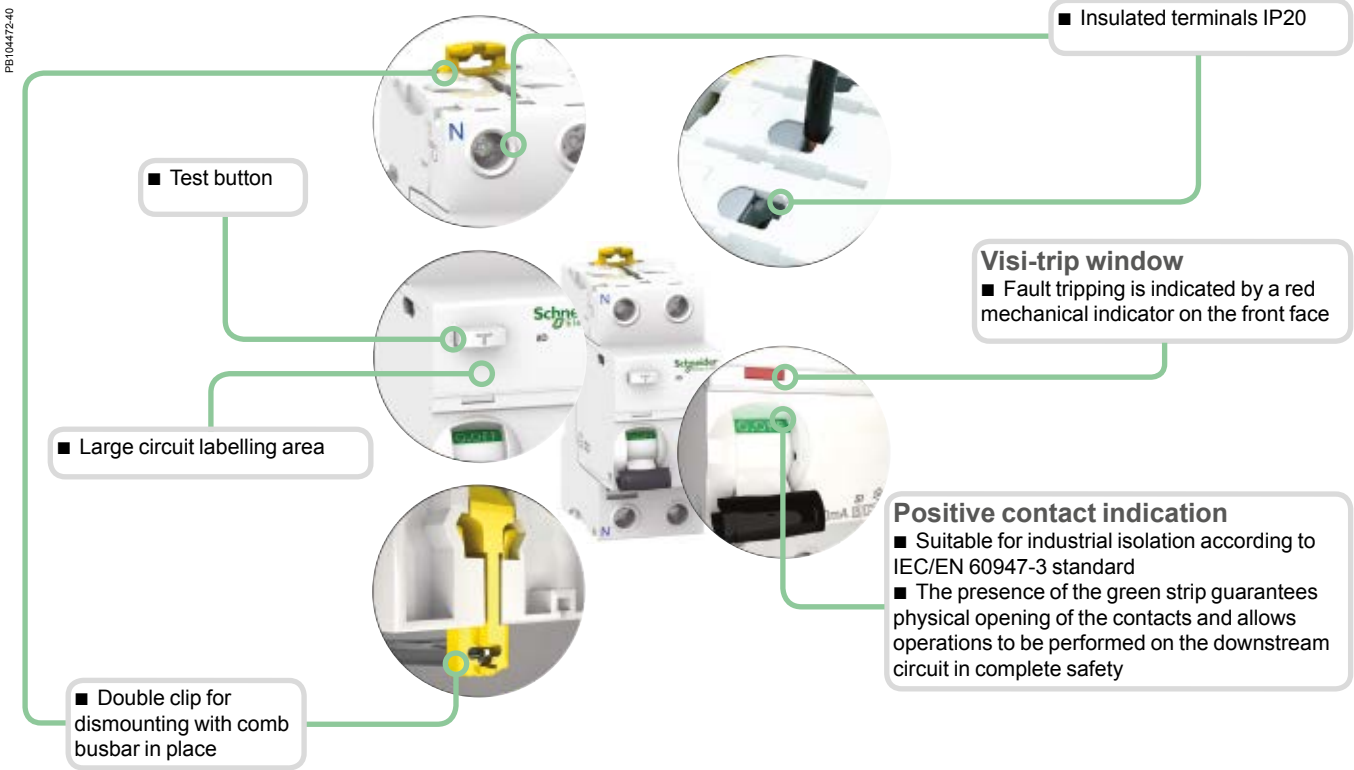

PB104472-40

## *SI* type

The *SI* type provides increased immunity from electrical interference and polluted or corrosive environments.

# RCCB-ID 125 A residual current circuit breakers

IEC/EN 61008-1  
VDE 0664



PB111263-33



PB107510-33

16940

- The RCCB-ID 125 A residual current circuit breakers provide:
  - protection of persons against electric shock by direct contact (30 mA),
  - protection of persons against electric shock by indirect contact (300 mA),
  - protection of installations against the risk of fire (300 mA).

### OFsp auxiliary

- Electrical indication: by OFsp auxiliary mounted to the left, it has a double changeover switch indicating the "open" or "closed" position of the RCCB-ID 125 A.

## Catalogue numbers

RCCB-ID 125 A residual current circuit breakers				
Type	AC	Sensitivity		Width in 9 mm module
		30 mA	300 mA	
4P	Rating 125 A	16905	16907	8
Voltage rating (Ue)		230 V		
		400 V		
Operating frequency		50 Hz		

## Auxiliary

Type				Width in 9 mm module
Contact OFsp	Contact	Voltage		
	1 A	110 V DC	16940	1
	6 A	230 V AC (AC15)		

# RCCB-ID 125 A residual current circuit breakers (cont.)

## Connection

■ By tunnel terminals for:

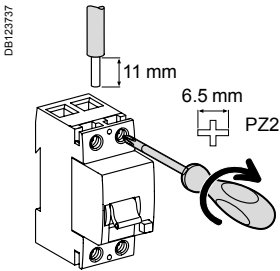

Type	Tightening torque	Copper cables	
		Rigid	Flexible or with ferrule
RCCB-ID	3 N.m	DB112804 	DB112805 
OFsp	0.8 N.m	1 x 1.5 to 50 mm <sup>2</sup> 2 x 1.5 to 16 mm <sup>2</sup>	1 x 1.5 to 35 mm <sup>2</sup> 2 x 1.5 to 16 mm <sup>2</sup>

## Technical data

### OFsp contact status, depending on the position of the residual current circuit breaker

Type				
RCCB-ID 125 A	Closed	■	-	-
	Open	-	■	-
	Tripped on fault	-	-	■
Contact OFsp	22/21 12/11	Open	Closed	Closed
	14/11	Closed	Open	Open

### Electrical characteristics

Insulation voltage (U <sub>i</sub> )	400 V
Pollution degree	3
Rated impulse withstand voltage (U <sub>imp</sub> )	4 kV
<b>According to IEC/EN 61008-1</b>	
Making and breaking capacity (I <sub>m</sub> /I <sub>Δm</sub> )	1250 A
Surge current withstand (8/20 μs) without tripping	250 A
Conditional rated short circuit current (I <sub>nc</sub> /I <sub>Δc</sub> )	With FU 125 A gG fuse 10,000 A
Behaviour in case of voltage drop	Residual current protection down to 0 V according to IEC/EN 61008-1 § 3.3.4

### Additional characteristics

Degree of protection	Device only	IP20 IP40 with screw shield
	Device in modular enclosure	IP40 Insulation class II
Endurance (O-C)	Electrical	> 2 000 cycles
	Mechanical	> 5 000 cycles
Operating temperature		-25°C to +40°C
Storage temperature		-40°C to +85°C
Range of test button operating voltage	30 mA	250...440 V AC
	300 mA	185...440 V AC



### Indication of the status of the RCCB-ID via the 3-position toggle and front panel indicator

- Closed (red indicator)
- Tripped on fault (green indicator)
- Open (green indicator)

## Weight (g)

### Residual current circuit breakers and auxiliary

Type	RCCB-ID 125 A	OFsp
4P	420	40

## Dimensions (mm)

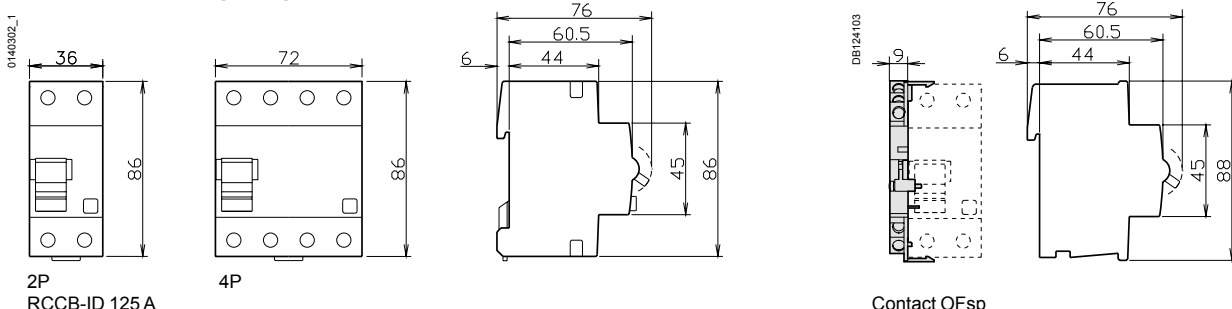



# iC60N circuit breakers (curves C, D)



Country approval pictograms



## IEC/EN 60947-2 IEC/EN 60898-1

- iC60N circuit breakers are multi-standard circuit breakers which combine the following functions:
  - circuit protection against short-circuit currents,
  - circuit protection against overload currents,
  - suitable for industrial isolation according to IEC/EN 60947-2, standard.
  - fault tripping indication by a red mechanical indicator in circuit breaker front face.

### Alternating current (AC) 50/60 Hz

Breaking capacity (Icu) according to IEC/EN 60947-2	Voltage (Ue)				Service breaking capacity (Ics)
	12 to 133 V	220 to 240 V	380 to 415 V	440 V	
Ph/Ph (2P, 3P, 4P)	12 to 133 V	220 to 240 V	380 to 415 V	440 V	100 % of Icu 75 % of Icu
Ph/N (1P)	12 to 60 V	100 to 133 V	220 to 240 V	-	
Rating (In) 1 to 4 A 6 to 63 A	50 kA 36 kA	50 kA 20 kA	50 kA 10 kA	25 kA 6 kA	

Breaking capacity (Icn) according to IEC/EN 60898-1	Voltage (Ue)	
	Ph/Ph	Ph/N
Rating (In) 1 to 63 A	400 V	230 V
	6000 A	

### Direct current (DC)

Breaking capacity (Icu) according to IEC/EN 60947-2	Voltage (Ue)					Service breaking capacity (Ics)
	12 to 60 V	≤ 72 V	≤ 125 V	≤ 180 V	≤ 250 V	
Between +/-	1P	2P	3P	4P		100 % of Icu
Number of poles	1P	2P	3P	4P		
Rating (In) 1 to 63 A	15 kA	10 kA	10 kA	10 kA	10 kA	

## Catalogue numbers

iC60N circuit breaker								
Type	1P		2P		3P		4P	
	E446982 		E446984 		E446985 		E446987 	
Auxiliaries	See page 21							
Vigi iC60	See page 14							
Rating (In)	Curve		Curve		Curve		Curve	
	C	D	C	D	C	D	C	D
1 A	A9F74101	A9F75101	A9F74201	A9F75201	A9F74301	A9F75301	A9F74401	A9F75401
2 A	A9F74102	A9F75102	A9F74202	A9F75202	A9F74302	A9F75302	A9F74402	A9F75402
3 A	A9F74103	A9F75103	A9F74203	A9F75203	A9F74303	A9F75303	A9F74403	A9F75403
4 A	A9F74104	A9F75104	A9F74204	A9F75204	A9F74304	A9F75304	A9F74404	A9F75404
6 A	A9F74106	A9F75106	A9F74206	A9F75206	A9F74306	A9F75306	A9F74406	A9F75406
10 A	A9F74110	A9F75110	A9F74210	A9F75210	A9F74310	A9F75310	A9F74410	A9F75410
16 A	A9F74116	A9F75116	A9F74216	A9F75216	A9F74316	A9F75316	A9F74416	A9F75416
20 A	A9F74120	A9F75120	A9F74220	A9F75220	A9F74320	A9F75320	A9F74420	A9F75420
25 A	A9F74125	A9F75125	A9F74225	A9F75225	A9F74325	A9F75325	A9F74425	A9F75425
32 A	A9F74132	A9F75132	A9F74232	A9F75232	A9F74332	A9F75332	A9F74432	A9F75432
40 A	A9F74140	A9F75140	A9F74240	A9F75240	A9F74340	A9F75340	A9F74440	A9F75440
50 A	A9F74150	A9F75150	A9F74250	A9F75250	A9F74350	A9F75350	A9F74450	A9F75450
63 A	A9F74163	A9F75163	A9F74263	A9F75263	A9F74363	A9F75363	A9F74463	A9F75463
Width in 9-mm modules	2		4		6		8	
Accessories	See page 94							

# iC60H circuit breakers (curve C)



Country approval pictograms



## IEC/EN 60947-2 IEC/EN 60898-1

- iC60H circuit breakers are multi-standard circuit breakers which combine the following functions:
  - circuit protection against short-circuit currents,
  - circuit protection against overload currents,
  - suitable for industrial isolation according to IEC/EN 60947-2, standard.
  - fault tripping indication by a red mechanical indicator in circuit breaker front face.

### Alternating current (AC) 50/60 Hz

#### Breaking capacity (Icu) according to IEC/EN 60947-2

	Voltage (Ue)				Service breaking capacity (Ics)
	12 to 133 V	220 to 240 V	380 to 415 V	440 V	
Ph/Ph (3P)	12 to 133 V	220 to 240 V	380 to 415 V	440 V	100 % of Icu
Ph/N (1P)	12 to 60 V	100 to 133 V	220 to 240 V	-	
Rating (In)	1 to 4 A	70 kA	70 kA	70 kA	50 kA
	6 to 63 A	42 kA	30 kA	15 kA	10 kA

#### Breaking capacity (Icn) according to IEC/EN 60898-1

	Voltage (Ue)
Ph/Ph	400 V
Ph/N	230 V
Rating (In) 1 to 63 A	10000 A

### Direct current (DC)

#### Breaking capacity (Icu) according to IEC/EN 60947-2

	Voltage (Ue)			Service breaking capacity (Ics)
	12 to 60 V	≤ 72 V	≤ 180 V	
Between +/-	12 to 60 V	≤ 72 V	≤ 180 V	100 % of Icu
Number of poles	1P		3P	
Rating (In) 1 to 63 A	20 kA	15 kA	15 kA	

## Catalogue numbers

### iC60H circuit breaker

Type	1P	3P
	<small>E46082</small>  1 2	<small>E46085</small>  1 3 5 2 4 6
Auxiliaries	See page 21	
Vigi iC60	See page 14	
Rating (In)	Curve C	Curve C
1 A	A9F84101	A9F84301
2 A	A9F84102	A9F84302
3 A	A9F84103	A9F84303
4 A	A9F84104	A9F84304
6 A	A9F84106	A9F84306
10 A	A9F84110	A9F84310
16 A	A9F84116	A9F84316
20 A	A9F84120	A9F84320
25 A	A9F84125	A9F84325
32 A	A9F84132	A9F84332
40 A	A9F84140	A9F84340
50 A	A9F84150	A9F84350
63 A	A9F84163	A9F84363
Width in 9-mm modules	2	6
Accessories	See page 94	

# iC60L circuit breakers (curve C)



## IEC/EN 60947-2 IEC/EN 60898-1 up to 40 A

- iC60L circuit breakers are multi-standard circuit breakers which combine the following functions:
  - circuit protection against short-circuit currents,
  - circuit protection against overload currents,
  - suitable for industrial isolation according to IEC/EN 60947-2, standard.
  - fault tripping indication by a red mechanical indicator in circuit breaker front face.

### Alternating current (AC) 50/60 Hz

Breaking capacity (Icu) according to IEC/EN 60947-2						Service breaking capacity (Ics)
Ph/Ph (2P, 3P, 4P)	Voltage (Ue)					
	12 to 133 V	220 to 240 V	380 to 415 V	440 V		100 % of Icu
Ph/N (1P)	12 to 60 V	100 to 133 V	220 to 240 V	-		
Rating (In)	1 to 4 A	100 kA	100 kA	100 kA	70 kA	100 % of Icu
	6 to 25 A	70 kA	50 kA	25 kA	20 kA	50 % of Icu <sup>(1)</sup>
	32 / 40 A	70 kA	36 kA	20 kA	15 kA	50 % of Icu
	50 / 63 A	70 kA	30 kA	15 kA	10 kA	50 % of Icu

Breaking capacity (Icn) according to IEC/EN 60898-1	
Ph/Ph	Voltage (Ue)
Ph/Ph	400 V
Ph/N	230 V
Rating (In)	1 to 40 A
	15000 A

### Direct current (DC)

Breaking capacity (Icu) according to IEC/EN 60947-2						Service breaking capacity (Ics)
Between +/-	Voltage (Ue)					
	12 to 60 V	≤ 72 V	≤ 125 V	≤ 180 V	≤ 250 V	100 % of Icu
Number of poles	1P		2P	3P	4P	
Rating (In) 1 to 63 A	25 kA	20 kA	20 kA	20 kA	20 kA	

## Catalogue numbers

### iC60L circuit breaker

Type	1P	2P	3P	4P
	E-60902 1 2	E-60904 1 3 2 4	E-60905 1 3 5 2 4 6	E-60907 1 3 5 7 2 4 6 8
Auxiliaries	See page 21			
Vigi iC60	See page 14			
Rating (In)	Curve C	Curve C	Curve C	Curve C
1 A	A9F94101	A9F94201	A9F94301	A9F94401
2 A	A9F94102	A9F94202	A9F94302	A9F94402
3 A	A9F94103	A9F94203	A9F94303	A9F94403
4 A	A9F94104	A9F94204	A9F94304	A9F94404
6 A	A9F94106	A9F94206	A9F94306	A9F94406
10 A	A9F94110	A9F94210	A9F94310	A9F94410
16 A	A9F94116	A9F94216	A9F94316	A9F94416
20 A	A9F94120	A9F94220	A9F94320	A9F94420
25 A	A9F94125	A9F94225	A9F94325	A9F94425
32 A	A9F94132	A9F94232	A9F94332	A9F94432
40 A	A9F94140	A9F94240	A9F94340	A9F94440
50 A	A9F94150	A9F94250	A9F94350	A9F94450
63 A	A9F94163	A9F94263	A9F94363	A9F94463
Width in 9-mm modules	2	4	4	6
Accessories	See page 94			

(1) 100 % of Icu for ratings 6 to 25 A under Ue 100 to 133 V AC Ph/Ph and Ue 12 to 60 V AC Ph/N.

# iC60 circuit breakers (curve C, D)

PB104439-40

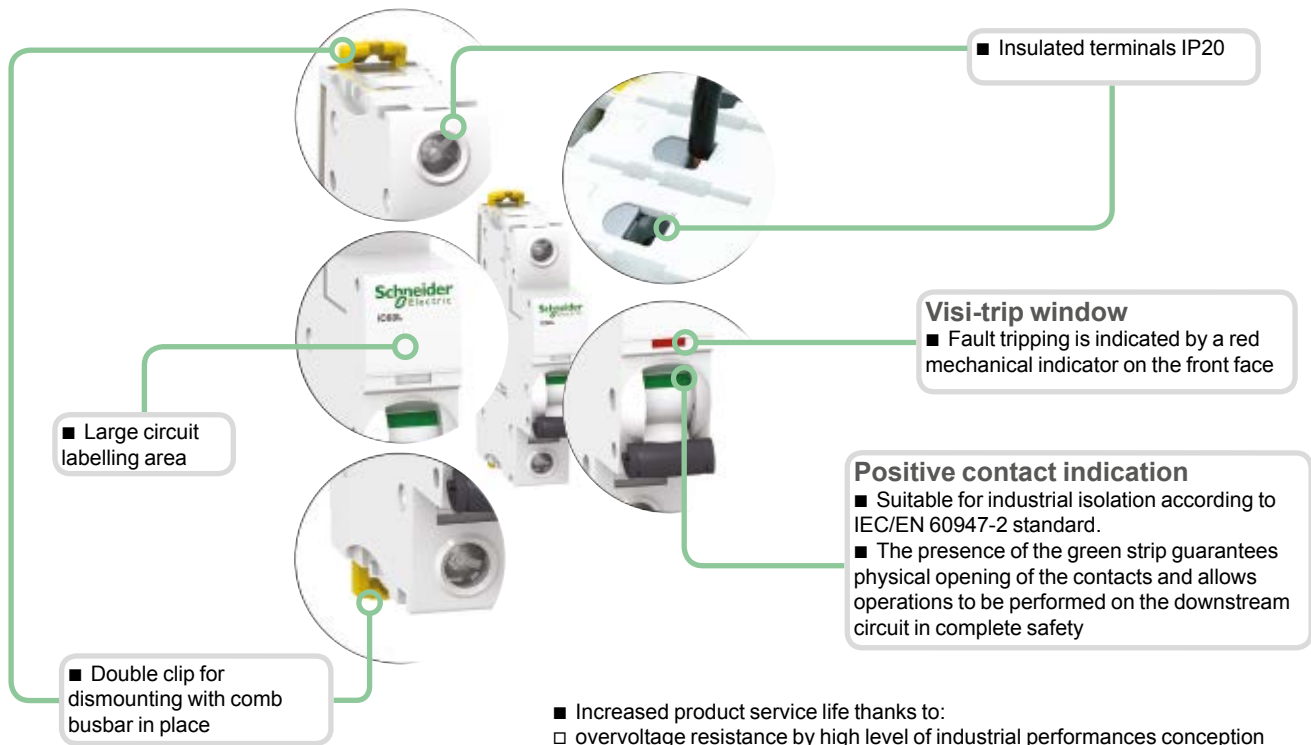

- Increased product service life thanks to:
  - overvoltage resistance by high level of industrial performances conception (pollution degree, rated impulse withstand voltage and insulation voltage),
  - high performance limitation (see limitation curves),
  - fast closing independent of the speed of actuation of the toggle.
- Remote indication, open/closed/tripped, by optional auxiliary contacts.
- Top or bottom electrical feeding.

# iC60 circuit breakers (curve C, D) (cont.)

## Connection

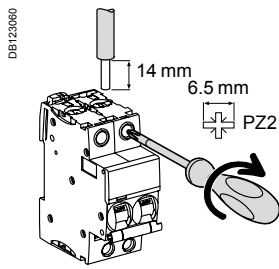

Rating	Tightening torque	Without accessory		With accessories		
		Rigid	Flexible or with ferrule	50 mm <sup>2</sup> Al terminal	Screw-on connection for ring terminal	Multi-cables terminal
1 to 25 A	2 N.m	DB122945	DB122946	DB122935	DB118789	DB118787
32 to 63 A	3.5 N.m	1 to 25 mm <sup>2</sup>	1 to 16 mm <sup>2</sup>	-	∅ 5 mm	-
		1 to 35 mm <sup>2</sup>	1 to 25 mm <sup>2</sup>	50 mm <sup>2</sup>		3 x 16 mm <sup>2</sup>
						3 x 10 mm <sup>2</sup>

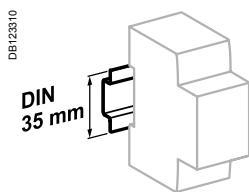

Clip on DIN rail 35 mm.

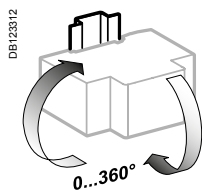

Indifferent position of installation.

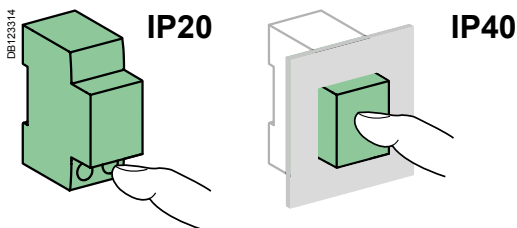

## Technical data

### Main characteristics

#### According to IEC/EN 60947-2

Insulation voltage (U <sub>i</sub> )	500 V AC	
Pollution degree	3	
Rated impulse withstand voltage (U <sub>imp</sub> )	6 kV	
Thermal tripping	Reference temperature	50 °C
Magnetic tripping	C curve	8 I <sub>n</sub> ± 20 %
	D curve	12 I <sub>n</sub> ± 20 %
Utilization category	A	

#### According to IEC/EN 60898-1

Rated making and breaking capacity of an individual pole (I <sub>cn1</sub> )	I <sub>cn1</sub> = I <sub>cn</sub>
--	------------------------------------

### Additional characteristics

Breaking capacity under 1 pole with IT 380-415 V isolated neutral system (case of double fault)	40 A	4 kA
	50/63 A	3 kA
Degree of protection (IEC 60529)	Device only	IP20
	Device in modular enclosure	IP40 Insulation class II
Endurance (O-C)	Electrical	10,000 cycles
	Mechanical	20,000 cycles
Overvoltage category (IEC 60364)	IV	
Operating temperature	-35°C to +70°C	
Storage temperature	-40°C to +85°C	
Tropicalization (IEC 60068-1)	Treatment 2 (relative humidity 95 % to 55°C)	

## Weight (g)

Circuit breaker	
Type	iC60
1P	125
2P	250
3P	375
4P	500

## Dimensions (mm)

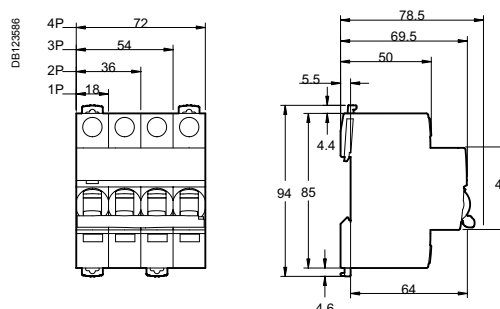

# Vigi iC60 add-on residual current devices (AC type)



IEC/EN 61009-1

PB 104466-35

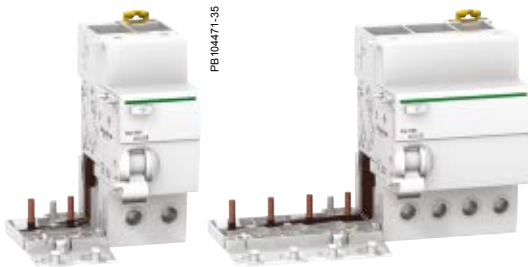

PB 104471-35

- Combined with iC60 circuit breaker, the Vigi iC60 provide:
  - protection of persons against electric shock by direct contact (30 mA),
  - protection of persons against electric shock by indirect contact (300 mA),
  - protection of installations against the risk of fire (300 mA).

## Catalogue numbers

Vigi iC60 add-on residual current devices for 230/400 V network						
Type	AC				Width in 9 mm modules	
Auxiliaries		Without auxiliaries				
		Sensitivity				
		30 mA	300 mA	300 mA		
DB122462 	Rating	25 A	A9V41225	A9V44225	-	3
		63 A	A9V41263	A9V44263	A9V15263	4
DB122463 	Rating	25 A	A9V41325	A9V44325	-	6
		63 A	A9V41363	A9V44363	A9V15363	7
DB122464 	Rating	25 A	A9V41425	A9V44425	-	6
		63 A	A9V41463	A9V44463	A9V15463	7
Voltage rating (Ue)	2P	230 - 240 V				
	3P-4P	400 - 415 V				
Operating frequency	50/60 Hz					
Accessories	See page 94					

Vigi iC60 add-on residual current devices for 110 V network					
Type	AC				Width in 9 mm modules
Auxiliaries		Without auxiliaries			
		Sensitivity			
		30 mA	300 mA		
DB122462 	Rating	25 A	A9V01225	A9V04225	3
		63 A	A9V01263	A9V04263	4
Voltage rating (Ue)	110 V				
Operating frequency	50/60 Hz				
Accessories	See page 94				

# Vigi iC60 add-on residual current devices (SI type)



IEC/EN 61009-1

PB 004466-35

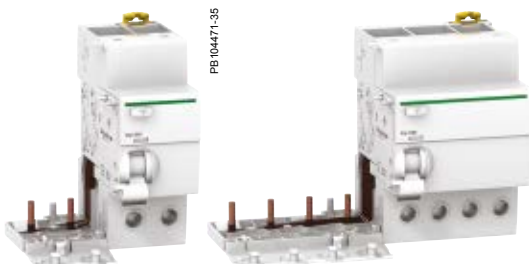

PB 004471-35

- Combined with iC60 circuit breaker, the Vigi iC60 provide:
  - protection of persons against electric shock by direct contact (30 mA),
  - protection of persons against electric shock by indirect contact (300 mA),
  - protection of installations against the risk of fire (300 mA).

The SI type provides increased immunity from electrical interference and polluted or corrosive environments.

## Catalogue numbers

Vigi iC60 add-on residual current devices for 230/400 V network					
Type		SI	Width in 9 mm modules		
Auxiliaries			Without auxiliaries		
<b>2P</b>	<b>Sensitivity</b>	<b>30 mA</b>	<b>300 mA</b>		
	Rating 63 A	<b>A9V61263</b>	<b>A9V65263</b>		4
<b>3P</b>	<b>Sensitivity</b>	<b>30 mA</b>	<b>300 mA</b>		
	Rating 63 A	<b>A9V61363</b>	<b>A9V65363</b>		7
<b>4P</b>	<b>Sensitivity</b>	<b>30 mA</b>	<b>300 mA</b>		
	Rating 63 A	<b>A9V61463</b>	<b>A9V65463</b>		7
Voltage rating (Ue)	2P	230 - 240 V			
	3P-4P	400 - 415 V			
Operating frequency	50/60 Hz				
<b>Accessories</b>	<b>See page 94</b>				

# Vigi iC60 add-on residual current devices (cont.)

PB104556-51



## Association iC60N, H, L + Vigi iC60

iC60	Vigi iC60 25 A	Vigi iC60 63 A
1 A to 25 A	■	■
32 A - 40 A	NO	■
50 A - 63 A	NO	■

PB104466-40

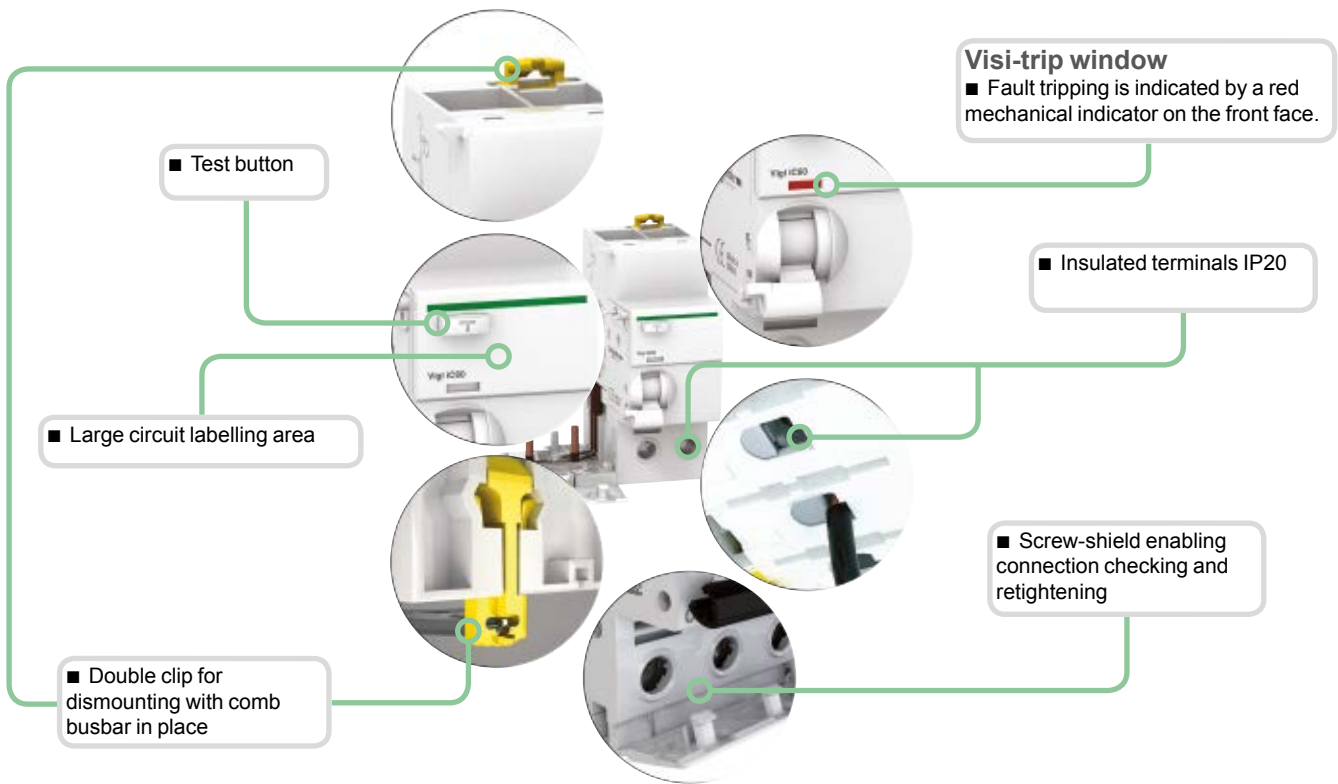



### SI type

The SI type provides increased immunity from electrical interference and polluted or corrosive environments.

## Connection

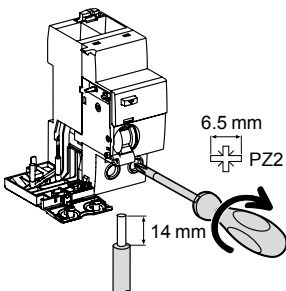
DB122948



Type	Rating	Tightening torque	Copper cables	
			Rigid	Flexible or with ferrule
Vigi iC60	25 A	2 N.m	 1 to 25 mm <sup>2</sup>	 1 to 16 mm <sup>2</sup>
	63 A	3.5 N.m		



# Vigi iC60 add-on residual current devices (AC, SI types) (cont.)

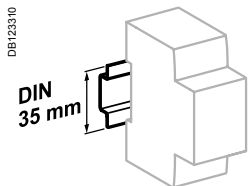

Clip on DIN rail 35 mm.

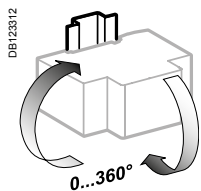

Indifferent position of installation.

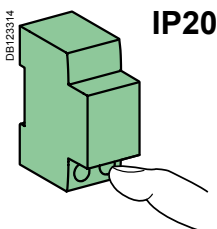

IP20

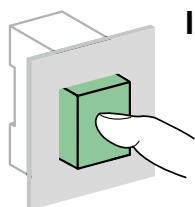



IP40

## Technical data

### Main characteristics

Insulation voltage (U <sub>i</sub> )	500 V
Pollution degree	3
Rated impulse withstand voltage (U <sub>imp</sub> )	6 kV

### According to IEC/EN 61009-1

Surge current withstand (8/20 μs) without tripping	AC types (no selective  )	250 Å
	AC types (selective  )	3 kÅ
	SI type	3 kÅ

Behaviour in case of voltage drop		Residual current protection down to 0 V according to IEC/EN 61009-1 § 3.3.8
-----------------------------------	---	---

### Additional characteristics

Degree of protection	Device only	IP20
	Device in modular enclosure	IP40 Insulation class II
Operating temperature	AC type	-5°C to +60°C
	SI types	 -25°C to +60°C
Storage temperature		-40°C to +85°C

## Weight (g)

### Add-on residual current devices

Type	Vigi iC60
2P	165
3P	210
4P	245

## Dimensions (mm)

### Vigi iC60 25 A

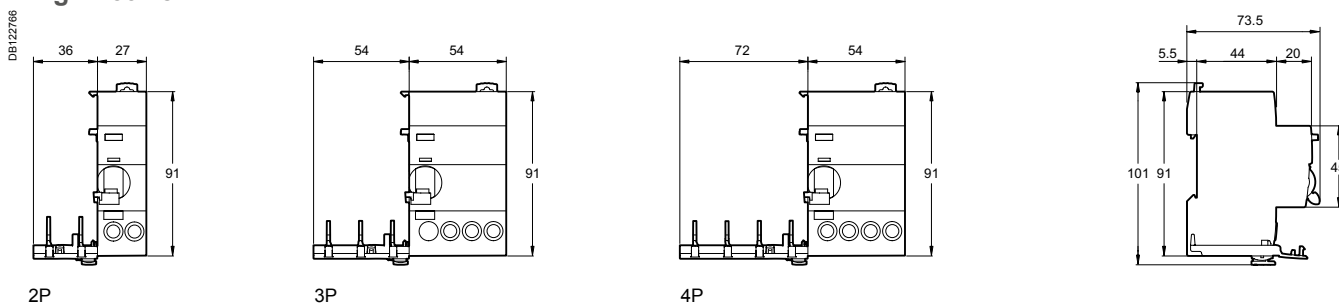

### Vigi iC60 63 A

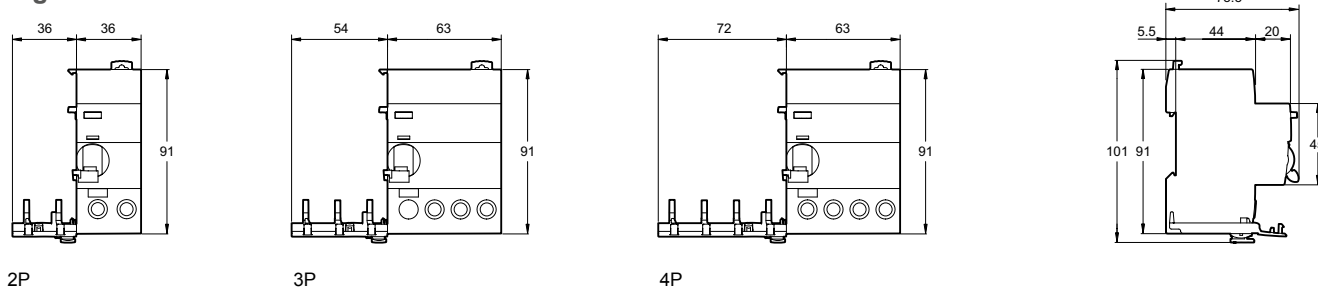



## IEC/EN 61009-1

- The residual current devices provide complete protection for final circuits (against overcurrents and insulation faults):
  - protection for users against electric shocks by direct contacts,
  - protection for users against electric shocks by indirect contacts,
  - protection of the installations against fire risks.
  
- The *SI* range has been designed to maintain a network with optimum safety and continuity of service in installations disturbed by:
  - extreme atmospheric conditions,
  - harmonic generating loads,
  - transient operating currents.



iDPN N Vigi 6000				
Type	AC	SI	Width in 9 mm modules	
Auxiliaries		See page 21		
1P+N Curve C	Sensitivity		30 mA	30 mA
	Rating (In)	6 A	A9D31606	-
	10 A	A9D31610	A9D33610	
	16 A	A9D31616	A9D33616	
	20 A	A9D31620	A9D33620	
	25 A	A9D31625	-	
	32 A	A9D31632	-	
	40 A	A9D31640	-	
Voltage rating (Ue)		230...240 V AC		
Operating frequency		50 Hz		
Accessories		See page 94		

DPN N Vigi 6000				
Type	AC	SI	Width in 9 mm modules	
Auxiliaries		See page 41		
3P+N Curve C	Sensitivity		30 mA	30 mA
	Rating (In)	16 A	A9D31716	A9D33716
	20 A	A9D31720	A9D33720	
	25 A	A9D31725	A9D33725	
	32 A	A9D31732	A9D33732	
	40 A	A9D31740	A9D33740	
	Voltage rating (Ue)		400 V AC	
Operating frequency		50 Hz		
Accessories		See page 100		



DPN N Vigi

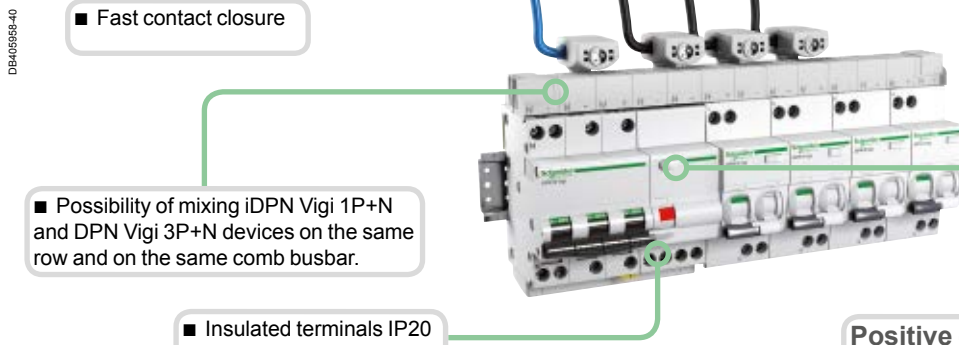

**Positive contact indication**  
 ■ A green strip on the toggle guarantees opening of all the poles in safety conditions (padlocking possible) for work to be carried out on live parts

# Residual current devices iDPN N Vigi and DPN N Vigi (cont.)

## Connection

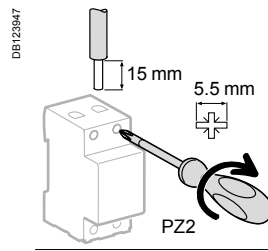

Rating	Tightening torque	Copper cables	
		Rigid	Flexible or with ferrule
6 to 40 A	2 N.m	1 to 16 mm <sup>2</sup>	1 to 10 mm <sup>2</sup>

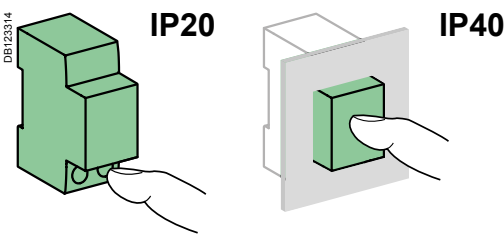
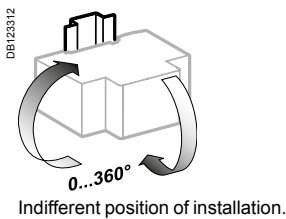
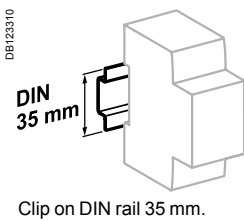

## Technical data

Main characteristics		
Type	iDPN N Vigi, DPN N Vigi	
Insulation voltage (U <sub>i</sub> )	400 V AC	
Pollution degree	3	
Rated impulse withstand voltage (U <sub>imp</sub> )	4 kV	
Setting temperature for ratings	30°C	
Magnetic tripping	Curve C	Between 5 and 10 In
According to IEC/EN 61009-1		
Limitation class	3	
Rated breaking capacity (I <sub>cn</sub> )	6000 A	
Rated residual breaking and making capacity (I <sub>Δm</sub> )	6000 A	
8/20 μs impulse withstand	Type AC	250 Å
	Type S/	3 kÅ
Behaviour in case of voltage drop		Residual current protection down to 0 V according to IEC/EN 61009-1 § 3.3.8
Additional characteristics		
Earth leakage protection with instantaneous tripping	30 mA	
Degree of protection (IEC 60529)	Device only	IP20
	Device in modular enclosure	IP40 Insulation class II
Endurance (O-C)	Electrical	≤ 20 A ≥ 25 A
		20,000 cycles 10,000 cycles
	Mechanical	20,000 cycles
Overvoltage category (IEC 60364)	III	
Operating temperature	Type AC	-5°C to +60°C
	Type S/	-25°C to +60°C
Storage temperature	-40°C to +85°C	
Tropicalization (IEC 60068-1)	Treatment 2 (relative humidity 95 % to 55°C)	

## Weight (g)

Residual current device		
Type	iDPN N Vigi	DPN N Vigi
1P+N	125	-
3P+N	-	498

## Dimensions (mm)

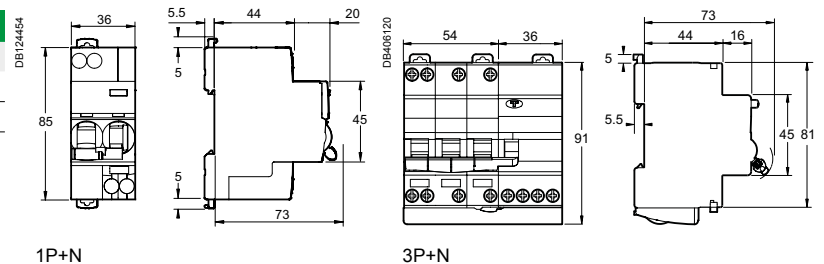



■ The electrical auxiliaries are combined with iC60 circuit breakers, iLD residual current circuit breakers, remote tripping switch disconnect

iSW-NA; they enable tripping or remote indication of their position (open/closed/tripped) upon a fault.

■ They are fastened by clips (without tools) to the left side of the breaker.

■ The iOF/SD+OF auxiliary is a 2-in-1 product: via a mechanical selector switch, it provides two contacts, OF+SD or OF+OF.

## Tripping auxiliaries:

### IEC/EN 60947-1

- iMN: undervoltage release
- iMNx: undervoltage release, independant from supply voltage
- iMX: shunt release
- iMX+OF: shunt release with open/close contact.

### EN 50550

- iMSU: overvoltage release.



## Indication auxiliaries:

### IEC/EN 60947-5-1

- iOF: open/close contact
- iSD: fault indicating contact
- iOF/SD+OF: open/close contact and switchable OF or SD contact.

DB404939



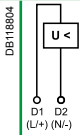
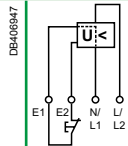

		Tripping	
Auxiliaries		iMN	iMNx
Type		<b>Undervoltage release</b>	
		Instantaneous	Independent of the supply voltage
			
Function		<ul style="list-style-type: none"> <li>Trips the device with which it is combined when its input voltage decreases (between 70 % and 35 % <math>U_n</math>). Prevents device closing again until its input voltage is restored</li> </ul>	<ul style="list-style-type: none"> <li>Tripping of the associated device by opening of the control circuit (e.g. push-button, dry contact)</li> <li>A drop in the supply voltage does not trip the associated device</li> <li>A locking push-button control allows the circuit protected (e.g. machine control) to be placed in safety configuration</li> </ul>
Wiring diagrams			
Use		<ul style="list-style-type: none"> <li>Emergency stoppage by normally closed push button</li> <li>Ensures the safety of power supply circuits for several machines by preventing "uncontrolled" restarting</li> </ul>	<ul style="list-style-type: none"> <li>Emergency stoppage with fail-safe principle</li> <li>Insensitive to control circuit voltage variation to increase service continuity</li> <li><b>Important: Before any servicing operation switch off the mains power supply (voltage presence at terminals E1/E2)</b></li> </ul>
Catalogue numbers		<b>A9A26960</b>	<b>A9A26969</b>
iC60, iID, iDPN Vigi, iSW-NA		■	■
<b>Technical specifications</b>			
Rated voltage ( $U_e$ )	V AC	220...240	220...240
	V DC	–	–
Standardised operating and non-response to voltage times ( $U_a$ )*		–	–
Maximum operating time		–	–
Minimum non-response time		–	–
Operating frequency	Hz	50/60	50/60
Red mechanical indicator		On front face	On front face
Width in 9 mm modules		2	2
Operating current		–	–
Number of contacts		–	–
Operating temperature	°C	-35...+70	-35...+70
Storage temperature	°C	-40...+85	-40...+85

\*( $U_a$ )

Volages measured between the phase and the neutral conductor, at which the iMSU device must control the associated protective device.

# Electrical auxiliaries for iC60, iID, iDPN Vigi, iSW-NA (cont.)

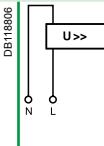
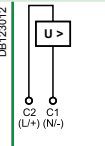
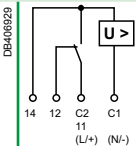
iMSU					iMX			iMX+OF	
Overvoltage release					Shunt release			With Open/Close auxiliary contact	
									
<ul style="list-style-type: none"> <li>Switches off the power supply by opening the breaker with which it is combined, in the event that the phase/neutral voltage is exceeded (loss of neutral). For a four-phase network, use three iMSU tripping auxiliaries</li> </ul>					<ul style="list-style-type: none"> <li>Trips the breaker when powered</li> </ul>			<ul style="list-style-type: none"> <li>Includes an open/close contact (OF) to indicate the "open" or "closed" position of the breaker</li> </ul>	
									
<ul style="list-style-type: none"> <li>Protection of equipment against overvoltages on the electrical network (neutral conductor break)</li> <li>Voltage monitoring between phase and neutral conductors</li> </ul>					<ul style="list-style-type: none"> <li>Emergency stoppage by normally open push button</li> </ul>			<ul style="list-style-type: none"> <li>Emergency stoppage by normally open push button</li> <li>Remote indication of the position of the associated breaker</li> </ul>	
<b>A9A26500</b>					<b>A9A26476</b>	<b>A9A26477</b>	<b>A9A26478</b>	<b>A9A26946</b>	<b>A9A26948</b>
■					■	■	■	■	■
230					100...415	48	12...24	100...415	12...24
-					110...130	48	12...24	110...130	12...24
255 V AC					275 V AC	300 V AC	350 V AC	400 V AC	-
No tripping					15 s	5 s	0.75 s	0.20 s	-
					3 s	1 s	0.25 s	0.07 s	-
50/60					50/60			50/60	
On front face					On front face			On front face	
2					2			2	
-					-			10 mA mini, 6 A maxi	
								≤ 24 V DC	
								48 V DC	
								≤ 130 V DC	
								≤ 240 V AC	
								415 V AC	
								1 NO/NC	
-35...+70					-35...+70			-35...+70	
-40...+85					-40...+85			-40...+85	

# Electrical auxiliaries for iC60, iID, iDPN Vigi, iSW-NA (cont.)

		Indication		
Auxiliaries		iOF	iSD	iOF/SD+OF
Type		Open/close auxiliary contact	Fault indicating contact	Double open/close or fault indicating contact
<b>Function</b>		<ul style="list-style-type: none"> <li>Changeover contact indicates "open" or "closed" position of the breaker</li> </ul>	<ul style="list-style-type: none"> <li>Changeover contact indicates position of the breaker; upon:                             <ul style="list-style-type: none"> <li>□ electrical fault</li> <li>□ action on tripping auxiliary</li> <li>■ Same indication as VISI-TRIP</li> </ul> </li> </ul>	<ul style="list-style-type: none"> <li>The iOF/SD+OF auxiliary is a 2-in-1 product: via a mechanical selector switch, it provides two contacts, OF+SD or OF+OF</li> </ul>
<b>Wiring diagrams</b>			<p>OF position      SD position</p>	
<b>Use</b>		<ul style="list-style-type: none"> <li>Remote indication of the position of the associated breaker</li> </ul>	<ul style="list-style-type: none"> <li>Remote indication of tripping upon a fault of the associated breaker</li> </ul>	<ul style="list-style-type: none"> <li>Remote indication of position and/or tripping upon a fault of the associated breaker</li> </ul>
<b>Catalogue numbers</b>		<b>A9A26924</b>	<b>A9A26927</b>	<b>A9A26929</b>
iC60, iID, iDPN Vigi, iSW-NA		■	■	■
<b>Technical specifications</b>				
Rated voltage (Ue)	V AC	24...415	24...415	24...415
	V DC	24...130	24...130	24...130
Operating frequency	Hz	50/60	50/60	50/60
Red mechanical indicator		–	On front face	On front face
Test function		On toggle	On toggle	On toggle
Width in 9 mm modules		1	1	1
Operating current		10 mA mini, 6 A maxi		
		24 V DC    6 A		
		48 V DC    2 A		
		60 V DC    1.5 A		
		130 V DC    1 A		
		24...240 V AC    6 A		
		415 V AC    3 A		
Number of contacts		1 NO/NC	1 NO/NC	1 NO/NC + 1 NO/NC
Operating temperature	°C	-35...+70	-35...+70	-35...+70
Storage temperature	°C	-40...+85	-40...+85	-40...+85



## Connection

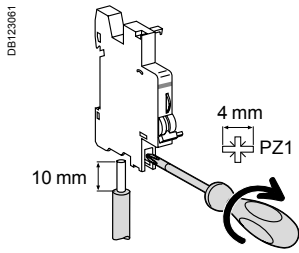

Type	Tightening torque	Copper cables		Multi-cables	
		Rigid	Flexible	Rigid	Cables with ferrule
		DB122945	DB123007	DB123011	DB123008
Indication auxiliaries	1 N.m	1 to 4 mm <sup>2</sup>	0.5 to 2.5 mm <sup>2</sup>	2 x 2.5 mm <sup>2</sup>	2 x 1.5 mm <sup>2</sup>
Tripping auxiliaries	1 N.m	1 to 6 mm <sup>2</sup>	0.5 to 4 mm <sup>2</sup>	2 x 2.5 mm <sup>2</sup>	2 x 2.5 mm <sup>2</sup>

## Technical data

### Weight (g)

Electrical auxiliaries	
Type	Weight (g)
iMN	69
iMNx	79
iMSU	68
iMX	64
iMX+OF	68
iOF	32
iSD	33
iOF/SD+OF	43

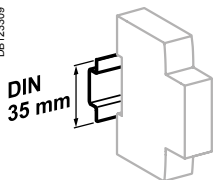

Clip on DIN rail 35 mm.

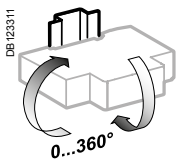

Indifferent position of installation.

## Dimensions (mm)

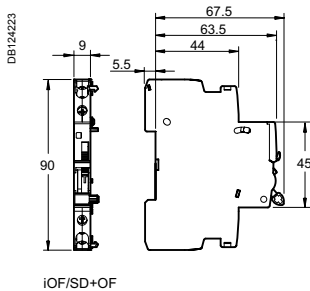

iOF/SD+OF

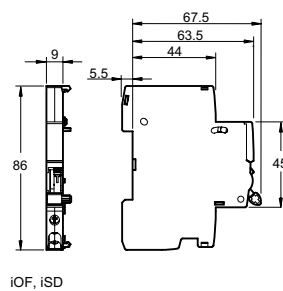

iOF, iSD

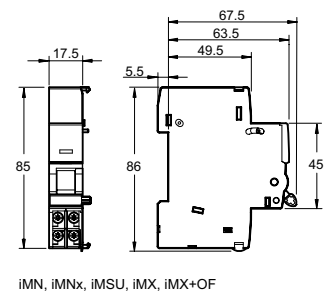

iMN, iMNx, iMSU, iMX, iMX+OF

PB100251-40



The RCA remote control system allows:

- Remote electrical control (opening and closing) of circuit breakers with or without Vigti add-on RCD, with or without auxiliary.
- Circuit-breaker resetting after tripping, in accordance with safety principles and the regulations in force.
- Local control by operating handle.
- Circuit placing in safety configuration by padlocking.

2 choices of operation after tripping:

- A: Enabling of remote circuit-breaker resetting;
- B: Inhibition of remote resetting.

## Catalogue numbers

RCA remote control			
Type			Width in 9 mm modules
For circuit breakers 1P, 1P+N, 2P	Voltage	230 V AC, 50/60 Hz	A9C70112   7
		230 V AC, 50/60 Hz	A9C70114   7
Auxiliaries			See page 21

DB123813



DB123572



Legend		
Type	Application	
OFF	All remote control inhibited	
auto	A	Circuit breaker remote reclosing after tripping allowed
	B	Circuit breaker remote reclosing after tripping inhibited
Green indicator lamp	Remote control possible	
Orange indicator lamp	Remote control impossible	
Y1	Latched order local control	
Y2	Impulse-type or latched order local control (depending on mode)	
Y3	Latched order centralized control	

## Connection

DB123565

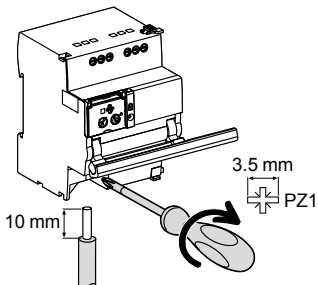

DB123566

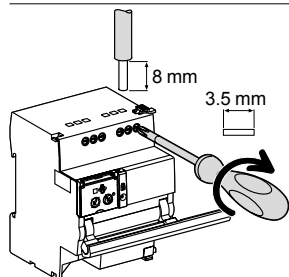

Terminal	Tightening torque	Without accessories		
		Copper cables		
		Rigid	Flexible	Flexible with ferrule
Power supply (N/P) Inputs (Y1/Y2)	1 N.m	DB123545 	DB123553 	DB123554 
Outputs (OF)	0.7 N.m	0.5 to 2.5 mm <sup>2</sup> 2 x 0.5 to 2 x 1.5 mm <sup>2</sup>	0.5 to 2.5 mm <sup>2</sup> 2 x 0.5 to 2 x 1.5 mm <sup>2</sup>	0.5 to 1.5 mm <sup>2</sup> 2 x 0.5 to 2 x 1.5 mm <sup>2</sup>

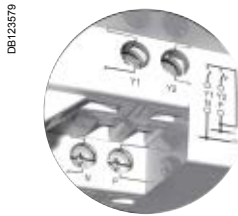
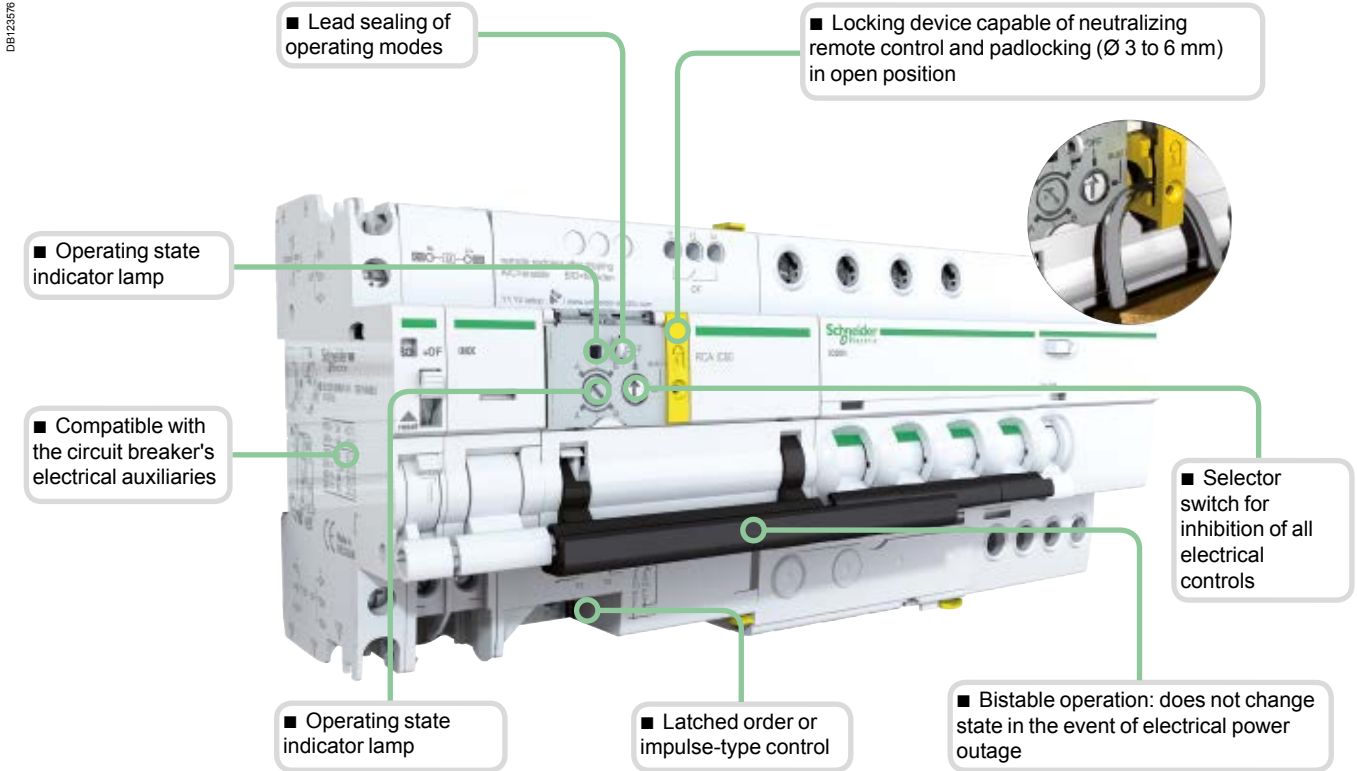

Legend	
Type	Application
Y1	Latched order local control
Y2	Impulse-type or latched order local control (depending on mode)
N	230 V AC power supply
P	
OF	Circuit-breaker state indication contact (open/closed)

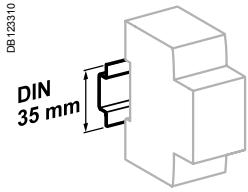

Clip on DIN rail 35 mm.

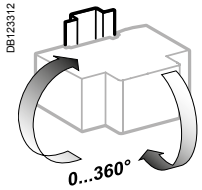

Indifferent position of installation.

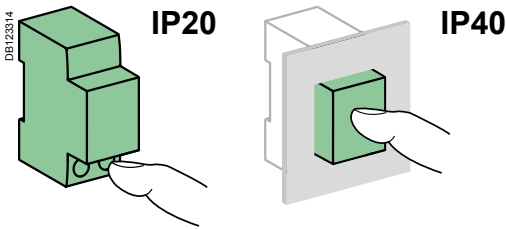

## Technical data

Control circuit	
Supply voltage (Ue) (N/P)	230 V AC, 50/60 Hz
Control voltage (Uc) Type 1 inputs (Y1/Y2)	230 V AC (as per IEC 61131-2)
Min. duration of control order (Y2)	≥ 200 ms
Response time (Y2)	< 500 ms
Consumption	≤ 1 W

Thermal self-protection with automatic Reset against overheating of the control circuit due to an abnormal number of operations

Endurance (O-C) (RCA combined with a circuit breaker)	
Electrical/Mechanical	10,000 cycles

Indication / Remote control		
Potential free changeover contact output (OF)	Min.	24 V AC/DC, 10 mA
	Max.	230 V AC, 1 A
Input (Y1/Y2)	230 V AC	5 mA

Additional characteristics		
Degree of protection (IEC 60529)	Device only	IP20
	Device in a modular enclosure	IP40 Insulation class II
Insulation voltage (Ui)		400 V
Degree of pollution (IEC 60947)		3
Rated impulse withstand voltage (Uimp)		6 kV
Operating temperature		-25°C to +60°C
Storage temperature		-40°C to +70°C
Tropicalization		Treatment 2 (relative humidity of 93 % at +40°C)

## Weight (g)

Remote controls	
Type	RCA
For 1P, 1P+N, 2P circuit breakers	400
For 3P, 3P+N, 4P circuit breakers	430

## Dimensions (mm)

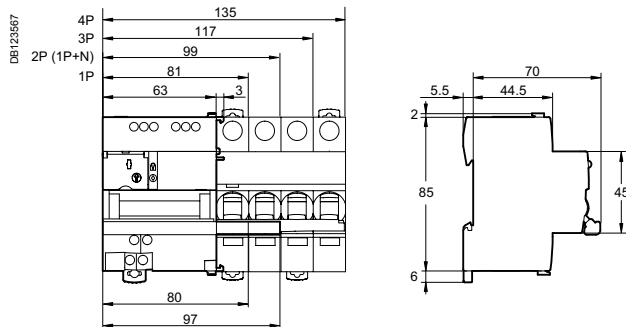



IEC/EN 61008-1

- The iID K residual current circuit breakers provide:
  - protection of persons against electric shock by direct contact
  - protection of persons against electric shock by indirect contact,
  - protection of installations against the risk of fire.



## Catalogue numbers

iID K residual current circuit breakers			
Type	AC	Width in 9-mm modules	
Product			
Auxiliaries	iID K		
	Without auxiliaries		
	<b>Sensitivity 30 mA</b>		
<b>2P</b> 	Rating	25 A	A9R50225
		40 A	A9R50240
<b>4P</b> 	Rating	25 A	A9R50425
		40 A	A9R50440
		63 A	A9R70463
Voltage rating (Ue)	2P	230 - 240 V	
	4P	400 - 415 V	
Operating frequency		50/60 Hz	

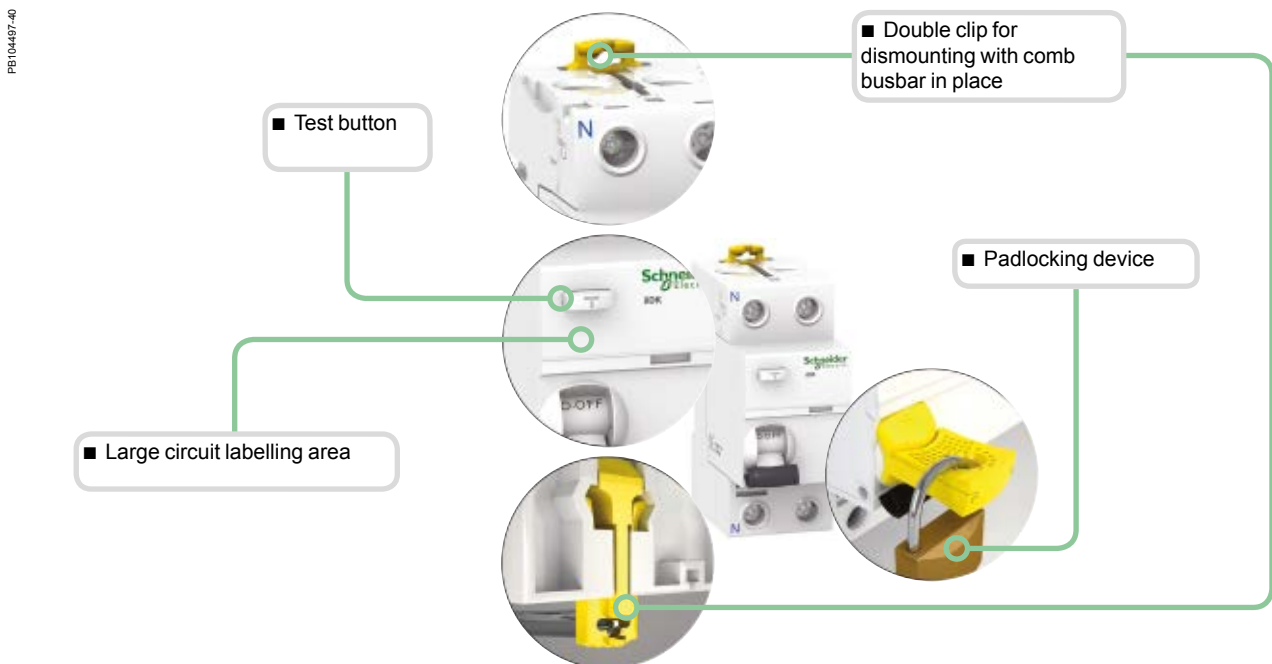

# iID K residual current circuit breakers (cont.)

## Connection

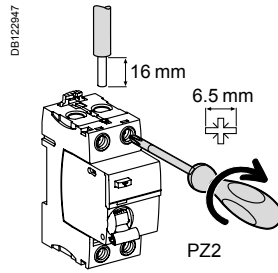

Type	Tightening torque	Copper cables	
		Rigid	Flexible or with ferrule
iID K	3.5 N.m	1 to 35 mm <sup>2</sup>	1 to 25 mm <sup>2</sup>

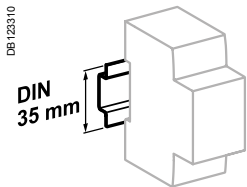

Clip on DIN rail 35 mm.

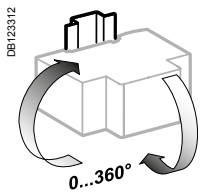

Indifferent position of installation.

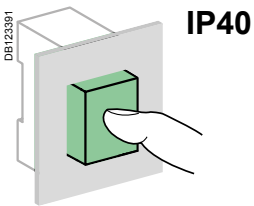

## Technical data

### Main characteristics

According to IEC/EN 61008-1

Insulation voltage (U <sub>i</sub> )	440 V
Pollution degree	2
Rated impulse withstand voltage (U <sub>imp</sub> )	4 kV
Making and breaking capacity (I <sub>m</sub> /I <sub>Δm</sub> )	25 to 40 A 63 A
Surge current withstand (8/20 μs) without tripping	Up to 200 Å
Conditional rated short circuit current (I <sub>nc</sub> /I <sub>Δc</sub> )	With iC60N/H/L 6000 A
	With fuse  100 A 4500 A
Behaviour in case of voltage drop	Residual current protection down to 0 V according to IEC/EN 61008-1 § 3.3.4

### Additional characteristics

Degree of protection	Device in modular enclosure	IP40
Endurance (O-C)	Electrical	2000 cycles (AC1)
	Mechanical	5000 cycles
Operating temperature		-5°C to +60°C
Storage temperature		-40°C to +85°C

## Weight (g)

### Residual current circuit breakers

Type	iID K
2P	210
4P	370

## Dimensions (mm)

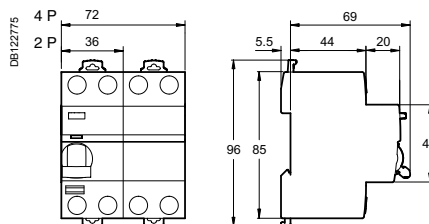

# iK60N circuit breakers (curve C)

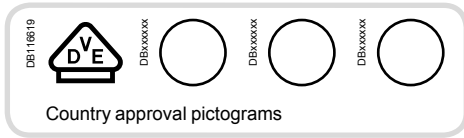

## IEC/EN 60898-1

- iK60N circuit breakers are circuit breakers which combine the following functions:
  - circuit protection against short-circuit currents,
  - circuit protection against overload currents,
  - disconnection, opening and closing.

### iK60N circuit breaker 50/60 Hz

Breaking capacity in short circuit (Icn) as per IEC/EN 60898-1		Service breaking capacity (Ics) 100 % of Icn
Ph/Ph	400 V	
Ph/N	230 V	
Rating (In) 2 to 32 A	6000 A	

## Catalogue numbers

### iK60N circuit breaker

Type	1P	3P
	E45092	E45095
Auxiliaries	Without auxiliaries	
Vigi iC60	Without Vigi iC60	
Rating (In)	Curve C	
2 A	A9K24102	-
6 A	A9K24106	-
10 A	A9K24110	-
16 A	A9K24116	-
20 A	-	A9K24320
25 A	-	A9K24325
32 A	-	A9K24332
Operating frequency	50/60 Hz	
Width in 9-mm modules	2	6
Accessories	Padlocking device cat. no. A9A26970	

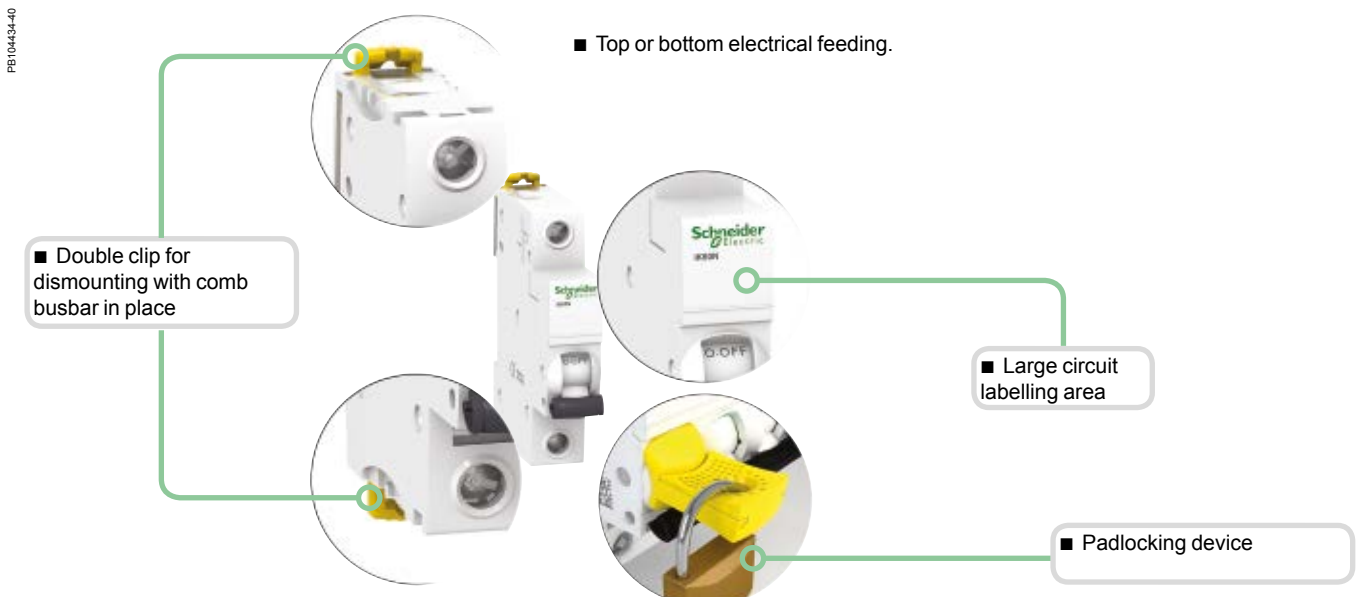

# iK60N circuit breakers (curve C) (cont.)

## Connection

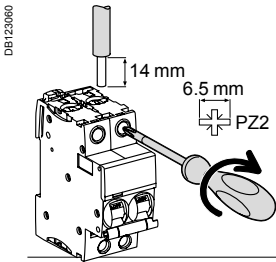

Type	Rating	Tightening torque	Copper cables	
			Rigid	Flexible or with ferrule
C curve	2 to 25 A	2 N.m	1 to 25 mm <sup>2</sup>	1 to 16 mm <sup>2</sup>
	32 A	3.5 N.m	1 to 35 mm <sup>2</sup>	1 to 25 mm <sup>2</sup>

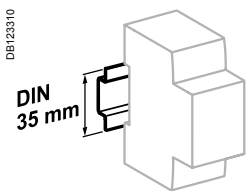

Clip on DIN rail 35 mm.

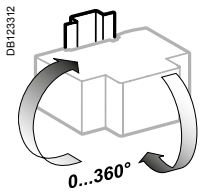

Indifferent position of installation.

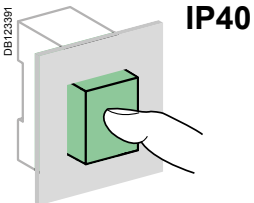

## Technical data

### Main characteristics

According to IEC/EN 60898-1

Insulation voltage (U <sub>i</sub> )	440 V AC
Pollution degree	2
Rated impulse withstand voltage (U <sub>imp</sub> )	4 kV
Thermal tripping	Reference temperature 30°C Temperature derating See module CA908007
Magnetic tripping	C curve 5 to 10 In
Limitation class	3
Rated making and breaking capacity of an individual pole (I <sub>cn1</sub> )	I <sub>cn1</sub> = I <sub>cn</sub>

### Additional characteristics

Degree of protection (IEC 60529)	Device in modular enclosure	IP40 Insulation class II
Endurance (O-C)	Electrical	10,000 cycles
	Mechanical	20,000 cycles
Overvoltage category (IEC 60364)		III
Operating temperature		-25°C to +60°C
Storage temperature		-40°C to +85°C

## Weight (g)

### Circuit-breaker

Type	iK60N
1P	100
3P	300

## Dimensions (mm)

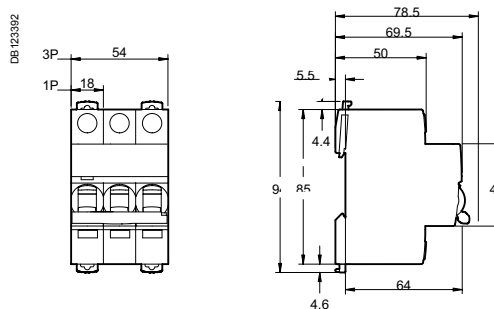



# C120H circuit breakers (curves C, D)

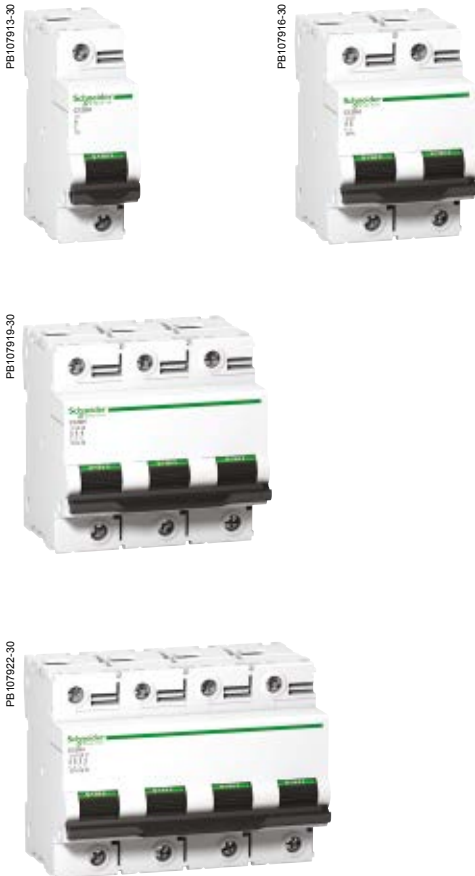

## IEC/EN 60898-1

C120H circuit breakers are multistandard circuit breakers that combine the following functions:

- circuit protection against short-circuit currents
- circuit protection against overload currents
- suitability for isolation in the industrial sector to IEC/EN 60947-2
- fault tripping and indication by adding auxiliaries.

### Alternating current (AC) 50/60 Hz

Breaking capacity (Icu) to IEC/EN 60947-2						Service breaking capacity (Ics)
Type	Voltage (V)					
1P	12 to 130 V	220 to 240 V	380 to 415 V	440 V		50 % of Icu
Rating (In)	80 to 125 A	30 kA	15 kA	4,5 kA <sup>(1)</sup>	-	
2P, 3P, 4P	12 to 130 V	220 to 240 V	380 to 415 V	440 V		50 % of Icu
Rating (In)	80 to 125 A	-	30 kA	15 kA	10 kA	

### Breaking capacity (Icn) to IEC/EN 60898-1

Type	Voltage (V)		Service breaking capacity (Ics)
1P, 2P, 3P, 4P	230 to 400 V		
Rating (In)	80 to 125 A	15000 A	50 % of Icn

(1) One-pole breaking capacity in IT isolated neutral system (double fault).

### Direct current (DC)

Breaking capacity (Icu) according to IEC/EN 60947-2							Service breaking capacity (Ics)
Between +/-	Voltage (Ue)						
	12 to 125 V	≤ 144 V	≤ 250 V	≤ 375 V	≤ 500 V		100 % of Icu
Number of poles	1P		2P	3P	4P		
Rating (In)	80 to 125 A	20 kA	15 kA	15 kA	15 kA	15 kA	

## Catalogue numbers

C120H circuit breaker								
Type	1P		2P		3P		4P	
Auxiliaries	See page 41							
Vigi C120	See page 36							
Rating (In)	Curve		Curve		Curve		Curve	
	C	D	C	D	C	D	C	D
80 A	A9N18446	A9N18490	A9N18457	A9N18501	A9N18468	A9N18512	A9N18479	A9N18523
100 A	A9N18447	A9N18491	A9N18458	A9N18502	A9N18469	A9N18513	A9N18480	A9N18524
125 A	A9N18448	A9N18492	A9N18459	A9N18503	A9N18470	A9N18514	A9N18481	A9N18525
Width in 9 mm modules	3		6		9		12	
Accessories	See page 100							

# C120H circuit breakers (curves C, D) (cont.)

FB107916-40

■ Terminals insulated to IP20



■ Location for 4 clip-on terminal markers



### Positive contact indication

- Suitability for isolation in the industrial sector to IEC/EN 60947-2.
- The presence of the green strip guarantees that the contacts open physically and allows work to be carried out safely on the downstream circuit.

- Longer product service life thanks to:
  - good overvoltage withstand capacity: products designed to provide a high industrial performance level (degree of pollution, rated impulse withstand voltage and insulation voltage).
  - high limitation performances (see limitation curves).
  - fast closure independent of toggle operating speed.
- Remote indication of the open/closed/tripped state by auxiliary contacts (optional).
- Power supply from above or below.

# C120H circuit breakers (curves C, D) (cont.)

## Connection

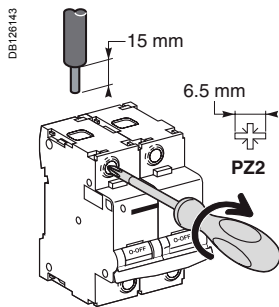

Rating	Tightening torque	Without access.		With accessories			
		Copper cables		50 mm <sup>2</sup> Al term.	Screw-on connection for ring terminal <sup>(1)</sup>	Multi-cable terminal	
		Rigid	Flexible or with ferrule		Rigid cables	Flexible cables	
80 to 125 A	3.5 N.m	DB1228145	DB1228146	DB1228145	DB118789	DB118787	
		1.5 to 50 mm <sup>2</sup>	1.5 to 35 mm <sup>2</sup>	16 to 50 mm <sup>2</sup>	∅ 5 mm	3 x 16 mm <sup>2</sup>	3 x 10 mm <sup>2</sup>

(1) For lugs up to 80 A, front or rear accessories.

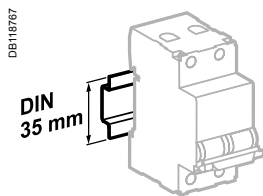

Clips onto 35 mm DIN rail.

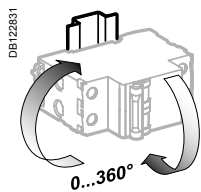

Any installation position.

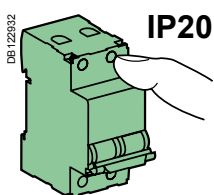

IP20

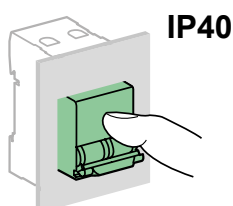

IP40

## Technical data

### Main characteristics

#### To IEC/EN 60947-2

Insulation voltage (U <sub>i</sub> )	500 V AC	
Degree of pollution	3	
Rated impulse withstand voltage (U <sub>imp</sub> )	6 kV	
Thermal tripping	Reference temperature	50°C

#### To IEC/EN 60898-1

Magnetic tripping	Curve C	5 and 10 In
	Curve D	10 and 14 In
Limitation class	3	

### Additional characteristics

Degree of protection (IEC 60529)	Device only	IP20
	Device in a modular enclosure	IP40 (IPXXD)
Endurance (O-C)	Electrical	5000 cycles (O-C)
	Mechanical	20000 cycles
Operating temperature	-30°C to +70°C	
Storage temperature	-40°C to +80°C	
Tropicalisation (IEC 60068-1)	Treatment 2 (relative humidity 95% at 55°C)	

## Weight (g)

### Circuit breaker

Type	C120H
1P	205
2P	410
3P	615
4P	820

## Dimensions (mm)

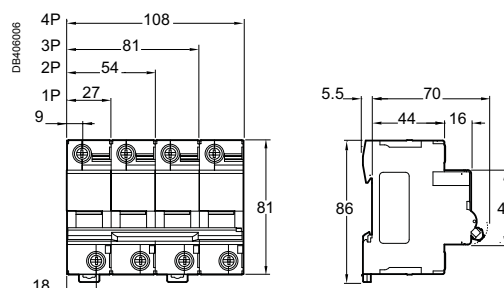

# Vigi C120 add-on residual current devices (type AC)

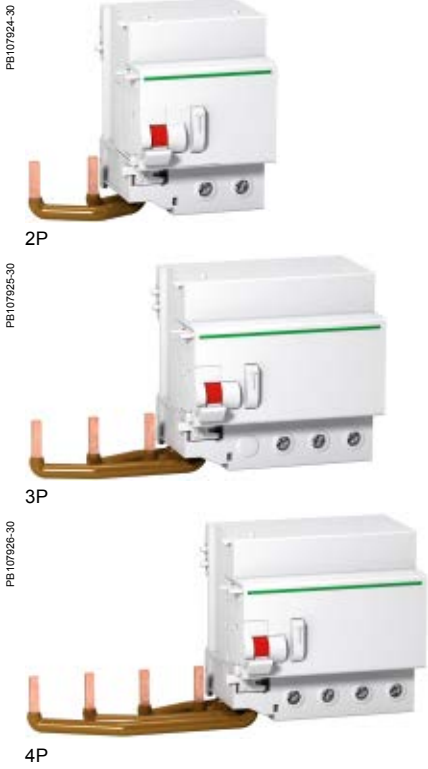
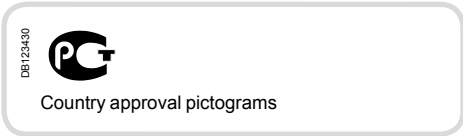

## EN 61009

When a Vigi C120 device is combined with a C120 circuit breaker, it provides the following functions:

- protection of persons against electric shock by direct contact (30 mA),
- protection of persons against electric shock by indirect contact (300 mA),
- protection of installations against fire hazards (300 mA).

## Catalogue numbers

Vigi C120 add-on residual current devices				
Type	AC	Width in 9 mm modules		
Product	Vigi C120			
Auxiliaries	Without auxiliary			
2P	Sensitivity	30 mA	300 mA	300 mA
		A9N18563	A9N18564	-
3P	Sensitivity	30 mA	300 mA	-
		A9N18566	A9N18567	-
4P	Sensitivity	30 mA	300 mA	-
		A9N18569	A9N18570	A9N18548
Operating voltage (Ue)		230...415 V		
Operating frequency		50/60 Hz		
Accessories		See page 100		

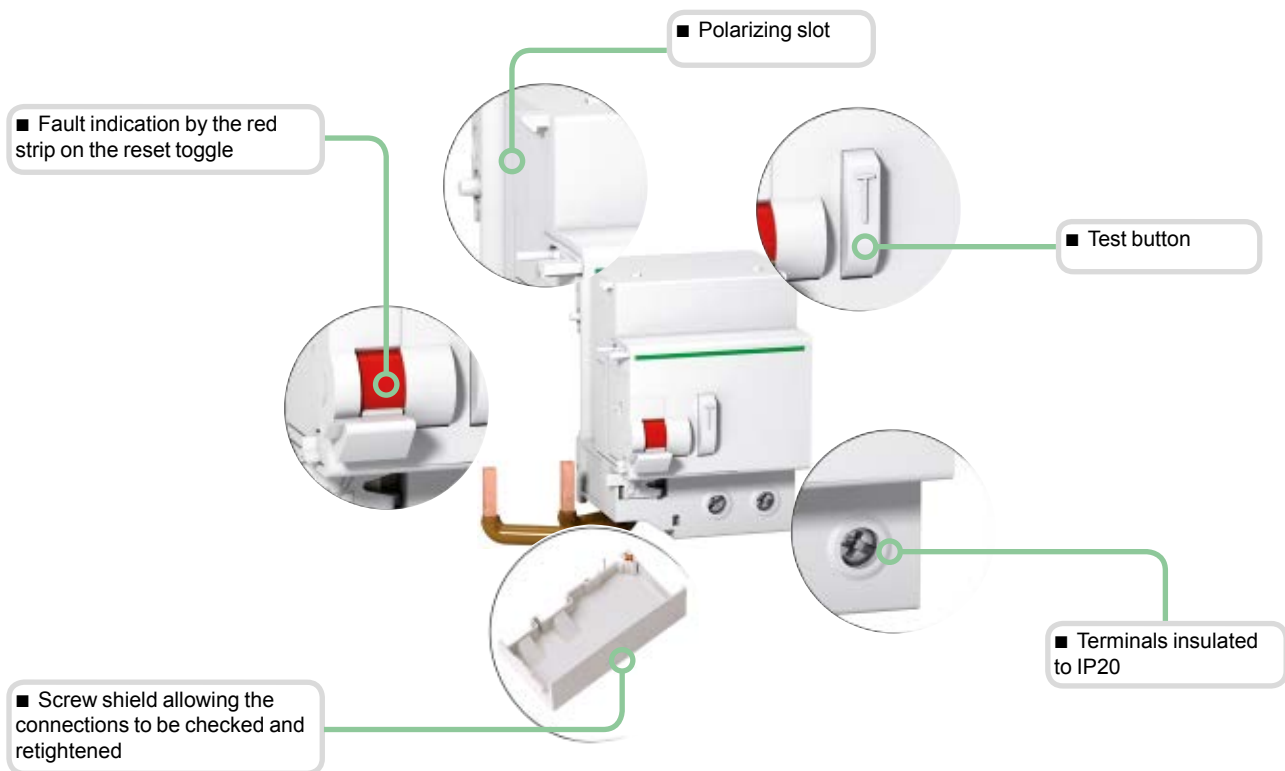

# Vigi C120 add-on residual current devices (types AC)

## Connection

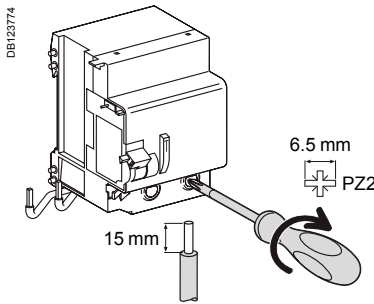

Type	Sensitivity	Tightening torque	Copper cables	
			Rigid	Flexible or with ferrule
Vigi C120	30...300 mA	3.5 N.m	1 to 50 mm <sup>2</sup>	1 to 35 mm <sup>2</sup>

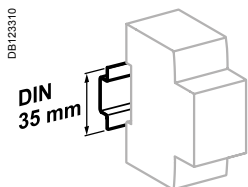

Clips onto 35 mm DIN rail.

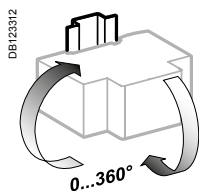

Any installation position.

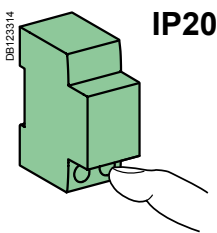

IP20

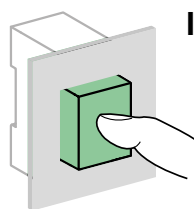

IP40

## Technical data

### Main characteristics

#### To IEC 60947-2

Insulation voltage (U <sub>i</sub> )	500 V AC
Degree of pollution	3
Rated impulse withstand voltage (U <sub>imp</sub> )	6 kV

#### To EN 61009

Impulse current withstand (8/20 μs) without tripping	Type AC (non-selective $\text{Ⓜ}$ )	250 Å
	Type AC (selective $\text{Ⓜ}$ )	3 kÅ

### Additional characteristics

Degree of protection	Device only	IP20
	Device in a modular enclosure	IP40 Insulation class II
Operating temperature	Type AC	-5 °C to +60 °C
	Types A and <i>SI</i>	-25 °C to +60 °C
Storage temperature		-40 °C to +85 °C

## Weight (g)

### Add-on residual current devices

Type	Vigi C120
2P	325
3P	500
4P	580

## Dimensions (mm)

### C120 + Vigi C120

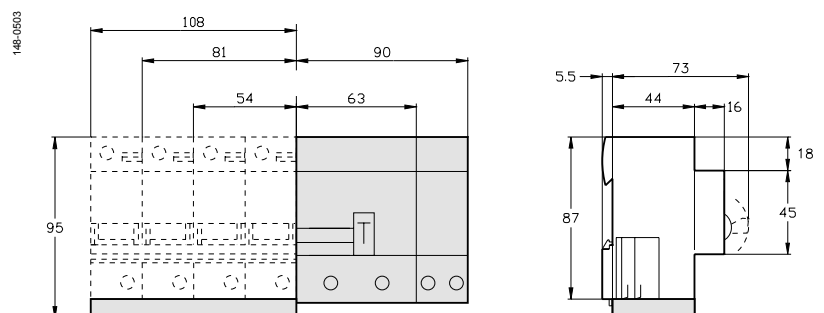



PB107193-34.eps



PB107194-34.eps



CE

### IEC 60947-2

The C60H-DC supplementary protectors are used in direct current circuits (Industrial control and automations, transport, renewable energy...). They combine the following functions of circuit protection against short-circuit and overload currents, control and isolation.

Direct current (DC)						
Breaking capacity (Icu) according to IEC 60947-2						Rated service breaking capacity (Ics)
Type	110 V	220 V	250 V	440 V	500 V	
<b>1P</b>						75 % Icu
<b>Rating (In)</b> 0.5 to 63 A	20 kA	10 kA	6 kA	-	-	
<b>2P (in series)</b>	<b>110 V</b>	<b>220 V</b>	<b>250 V</b>	<b>440 V</b>	<b>500 V</b>	75 % Icu
0.5 to 63 A	-	20 kA	20 kA	10 kA	6 kA	

### Catalogue numbers

C60H-DC		
Type	1P	2P
	<p>DB116598</p> <p>Supply from above or below, observing the polarity</p>	<p>DB124110</p> <p>Supply from above</p> <p>DB124111</p> <p>Supply from below</p>
<b>Auxiliaries</b>	<b>See page 41</b>	
<b>Rating (In)</b>	<b>Curve C</b>	<b>Curve C</b>
0.5 A	<b>A9N61500</b>	<b>A9N61520</b>
1 A	<b>A9N61501</b>	<b>A9N61521</b>
2 A	<b>A9N61502</b>	<b>A9N61522</b>
3 A	<b>A9N61503</b>	<b>A9N61523</b>
4 A	<b>A9N61504</b>	<b>A9N61524</b>
5 A	<b>A9N61505</b>	<b>A9N61525</b>
6 A	<b>A9N61506</b>	<b>A9N61526</b>
10 A	<b>A9N61508</b>	<b>A9N61528</b>
13 A	<b>A9N61509</b>	<b>A9N61529</b>
15 A	<b>A9N61510</b>	<b>A9N61530</b>
16 A	<b>A9N61511</b>	<b>A9N61531</b>
20 A	<b>A9N61512</b>	<b>A9N61532</b>
25 A	<b>A9N61513</b>	<b>A9N61533</b>
30 A	<b>A9N61514</b>	<b>A9N61534</b>
32 A	<b>A9N61515</b>	<b>A9N61535</b>
40 A	<b>A9N61517</b>	<b>A9N61537</b>
50 A	<b>A9N61518</b>	<b>A9N61538</b>
63 A	<b>A9N61519</b>	<b>A9N61539</b>
Number of modules of 9 mm	2	4
<b>Accessories</b>	<b>See page 100</b>	

### Connection

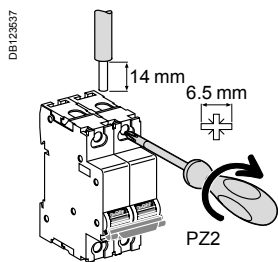

Rating	Tightening torque	Without accessory		With accessories			
		Copper cables		50 mm <sup>2</sup> AI terminal	Screw-on connection for ring terminal	Multi-cables terminal	
		Rigid / Stranded	Flexible or with ferrule			Rigid cables	Flexible cables
≤ 25 A	2.5 N.m	1 to 25 mm <sup>2</sup>	1 to 16 mm <sup>2</sup>	-	Ø 5 mm	-	-
> 25 A	3.5 N.m	1 to 35 mm <sup>2</sup>	1 to 25 mm <sup>2</sup>	50 mm <sup>2</sup>		3 x 16 mm <sup>2</sup>	3 x 10 mm <sup>2</sup>

### Multi-cables connection

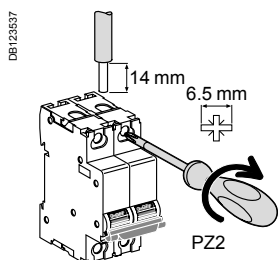

Rating	Tightening torque	Without accessory			
		2 Copper cables		3 Multi-cables / Different wires	
		Rigid / Stranded	Flexible or with ferrule	Flexible / Stranded	Flexible / Stranded / Rigid
≤ 25 A	2.5 N.m	2 x 1 mm <sup>2</sup> to 2 x 10 mm <sup>2</sup>		3 x 1 mm <sup>2</sup>	2 x 2.5 mm <sup>2</sup> + 1 x 1.5 mm <sup>2</sup>
> 25 A	3.5 N.m	2 x 1 mm <sup>2</sup> to 2 x 16 mm <sup>2</sup>		3 x 4 mm <sup>2</sup>	2 x 10 mm <sup>2</sup> + 1 x 6 mm <sup>2</sup>

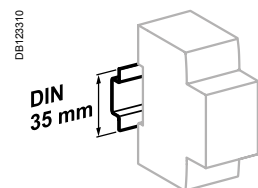

Clip on DIN rail 35 mm.

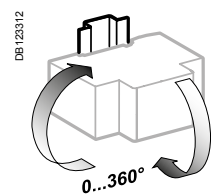

Indifferent position of installation.

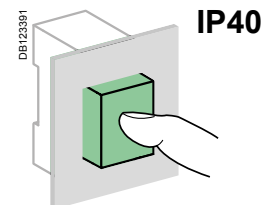

### Technical data

- Tripping curves: C curve - Overcurrent protection for any type of application.
- Positive break indication - the green strip indicates that all the poles are open and allows work to be carried out on the downstream circuit in complete safety.
- Suitable for isolation as defined in IEC 60947-2.
- Increase in the service life of the product: thanks to fast closure independent of the speed of action on the handle.
- Current limitation in the event of a fault: fast opening of the contacts prevents the loads from being destroyed in the event of a short-circuit.

Main characteristics		
According to IEC 60947-2		
Insulation voltage (Ui)		500 V DC
Rated voltage (Un)	1P	250 V DC
	2P	500 V DC
Operating voltage (Ue)	1P	24...250 V DC
	2P	24...500 V DC
Pollution degree		3
Rated impulse withstand voltage (Uimp) under frame		6 kV
Magnetic tripping (Ii)		8.5 In (± 20 %) (compatible with curve C)
Additional characteristics		
Degree of protection (IEC 60529)	Device in modular enclosure	IP40
Utilization category		A (no delay in accordance with IEC 60947-2 standards)
Endurance (O-C)	Electrical	3,000 cycles (where L/R=2 ms) 6,000 cycles where the circuit is resistive
	Mechanical	20,000 cycles
Tropicalization (IEC 60068-2)		Treatment 2 (relative humidity 95 % at 55°C)
Operating temperature		-25°C to 70°C
Storage temperature		-40°C to 85°C



Failure to match polarity during connection may lead to a fire hazard and/or serious injury.

- The connection polarity must be observed (marked on the front panel).
- Use only with direct current.

### Weight (g)

Circuit-breaker	
Type	C60H-DC
1P	128 g
2P	256 g

### Dimensions (mm)

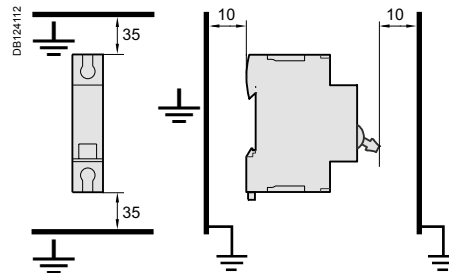
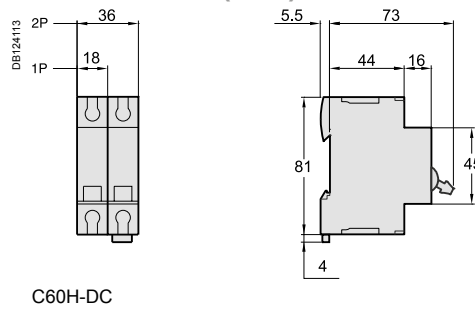

Details of minimum distance between circuit-breaker and earthed metal parts for circuit-breaker intended for use without enclosure.



- The electrical auxiliaries provide the remote tripping or position (open/closed/tripped) indication functions of these devices in the event of a fault.
- They clip on (no tool required) to the left-hand side of the associated device.
- The OF+SD/OF auxiliary is a two-in-one product: a mechanical selector switch is used to select one of two contacts: OF+SD or OF+OF.

## Tripping auxiliaries

### IEC/EN 60947-1



- MN: undervoltage release
- MX: shunt release
- MX+OF: shunt release with open/closed contact.

## Indication auxiliaries



### IEC/EN 60947-5-1

- OF: open/closed contact
- SD: fault indicating contact
- OF+SD/OF: choice of open/closed contact and OF or SD contact via the selector switch.

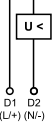
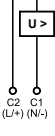
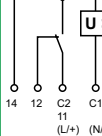
# Electrical auxiliaries for C120, C60H-DC, DPN N Vigi (cont.)

		Tripping		
Auxiliaries		MN	MX	MX+OF
Type		Undervoltage release	Shunt release	With Open/Close auxiliary contact
		Instantaneous		
				
Function				
		<ul style="list-style-type: none"> <li>Causes the device with which it is associated to trip when its input voltage decreases (between 70 % and 35 % of <math>U_n</math>). Prevents the device from closing until its input voltage has been restored</li> </ul>	<ul style="list-style-type: none"> <li>Trips the associated device when it is powered on</li> </ul>	<ul style="list-style-type: none"> <li>Includes an open/close contact (OF) to indicate the "open" or "closed" position of the breaker</li> </ul>
Wiring diagrams				
				
Utilization				
		<ul style="list-style-type: none"> <li>Emergency stop via a normally-closed pushbutton</li> <li>Ensures the safety of the power supply circuits of several machines by preventing accidental startups</li> </ul>	<ul style="list-style-type: none"> <li>Emergency stop via a normally-open pushbutton.</li> </ul>	<ul style="list-style-type: none"> <li>Emergency stop via a normally-open pushbutton</li> <li>Remote indication of the position of the associated device</li> </ul>
Catalogue numbers		A9N26960	A9N26476	A9N26946
Technical specifications				
Rated voltage	V AC	220...240	100...415	100...415
	V DC ( $U_e$ )	–	110...130	110...130
Operating frequency	Hz	50/60	50/60	50/60
Mechanical state indicator light, red		On front face	On front face	On front face
Width in 9 mm modules		2	2	2
Operating current		–	–	10 mA mini, 6 A maxi ≤ 24 V DC 48 V DC ≤ 130 V DC ≤ 240 V AC 415 V AC
Number of contacts		–	–	1 NO/NC
Operating temperature	°C	-25...+50	-25...+50	-25...+50
Storage temperature	°C	-40...+85	-40...+85	-40...+85
Standards				
IEC/EN 60947-1		■	■	■
EN 60947-2		■	–	–

# Electrical auxiliaries for C120, C60H-DC, DPN N Vigi (cont.)

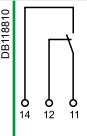
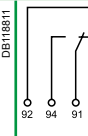
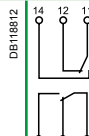
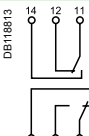
		Indication		
Auxiliaries	OF	SD	OF+SD/OF	
Type	Open/closed auxiliary contact	Fault indicating contact	Double open/closed or fault indicating contact	
				
Function	<ul style="list-style-type: none"> <li>Changeover contact indicating the "open" or "closed" position of the associated device</li> </ul>	<ul style="list-style-type: none"> <li>Changeover contact indicating the position of the associated device in the event of:               <ul style="list-style-type: none"> <li>electrical fault</li> <li>action on the tripping auxiliary</li> </ul> </li> <li><b>⚠ Not compatible with a ID residual current circuit breaker, use an OF+SD/OF in the SD position</b></li> </ul>	<ul style="list-style-type: none"> <li>The OF+SD/OF auxiliary is a two-in-one product: choice of OF + SD or OF + OF contact via the selector switch</li> </ul>	
Wiring diagrams			 	
Utilization	<ul style="list-style-type: none"> <li>Remote indication of the position of the associated device</li> </ul>	<ul style="list-style-type: none"> <li>Remote fault tripping indication of the associated device</li> </ul>	<ul style="list-style-type: none"> <li>Remote position and/or fault tripping indication of the associated device</li> </ul>	
Catalogue numbers	<b>A9N26924</b>	<b>A9N26927</b>	<b>A9N26929</b>	

Technical specifications				
Rated voltage (Ue)	V AC	24...415	24...415	24...415
	V DC	24...130	24...130	24...130
Operating frequency	Hz	50/60	50/60	50/60
Mechanical state indicator		–	On front face	On front face
Test function		On front face	On front face	On front face
Width in 9 mm modules		1	1	1
Operating current		10 mA mini, 6 A maxi		
		24 V DC	6 A	
		48 V DC	2 A	
		60 V DC	1.5 A	
		130 V DC	1 A	
		24...240 V AC	6 A	
Number of contacts		1 NO/NC	1 NO/NC	1 NO/NC + 1 NO/NC
		415 V AC	3 A	
Operating temperature	°C	-25...+50	-25...+50	-25...+50
	°C	-40...+85	-40...+85	-40...+85
Storage temperature	°C	-40...+85	-40...+85	-40...+85
	°C	-40...+85	-40...+85	-40...+85
Standards				
IEC/EN 60947-5-1		■	■	■
EN 62019-2 <sup>(1)</sup>		■	■	■
(1) For C120.				

## Connection

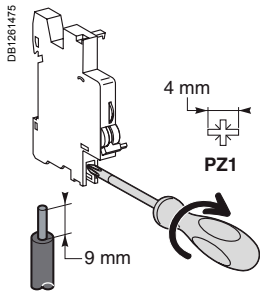

Type	Tightening torque	Copper cables	
		Rigid	Flexible or with ferrule
Indication and tripping auxiliaries	1 N.m	0.5 to 2.5 mm <sup>2</sup>	2 x 1.5 mm <sup>2</sup>

## Dimensions

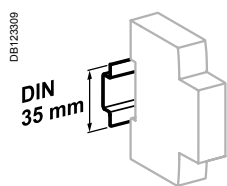
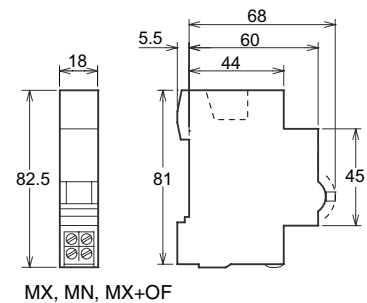
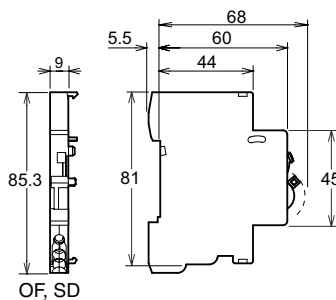
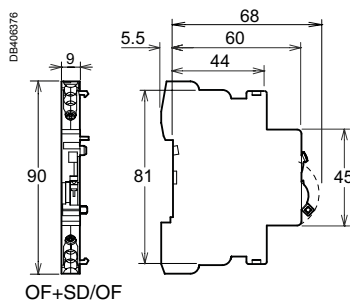

Clip on DIN rail 35 mm.

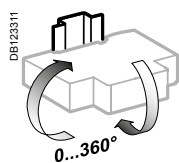

Indifferent position of installation.

## Weight (g)

Electrical auxiliaries	
Type	Weight (g)
MN	66
MX	60
MX+OF	65
OF	30
SD	30
OF+SD/OF	38



The Type 1 range of surge arresters meets the normative withstand capability of current wave type 10/350  $\mu$ s (8/20  $\mu$ s for Type 2 surge arresters).

It is suitable for use with TN-S and TN-C earthing connection systems (neutral point connection).

iPRF1 12.5r and PRD1 25r surge arresters are fitted with a remote transfer contact to send "end-of-life indication" information.

PRD1 25r surge arresters are fitted with easy-to-replace withdrawable cartridges.

### iPRF1 12.5r/PRD1 25r

The Type 1 surge arrester is recommended for electrical installations in the service sector and industrial buildings protected by a lightning conductor or by a meshed cage.

It protects electrical installations against direct lightning strikes.

It is used to conduct the direct lightning current, propagating from the earth conductor to the network conductors.

It must be installed with an upstream disconnection device, such as a fuse or circuit-breaker, whose breaking capacity must be at least equal to the maximum prospective short-circuit current at the installation point.

iPRF1 12.5r and PRD1 25r surge arresters also provide Type 2 protection and protect the electrical installation by finely clipping the lightning wave overvoltages.

PB104275-35-b



iPRF1 12.5r (3P+N)

PB104260-35



PRD1 25r (3P+N)

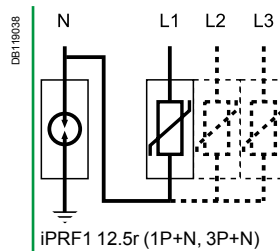

Type	Product solution	
<b>Fixed surge arrester</b>	<b>1P+N</b>	<b>3P+N</b>
iPRF1 12.5r T1, T2	<b>A9L16632</b>	<b>A9L16634</b>

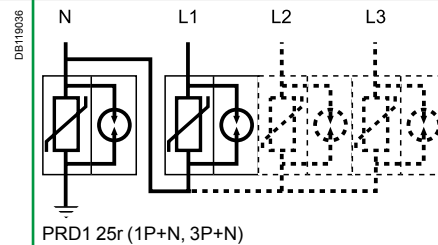

<b>Cartridge surge arrester</b>	<b>1P+N</b>	<b>3P+N</b>
PRD1 25r T1 + T2	<b>16330</b>	<b>16332</b>



C1 Neutral-350

Surge arresters	Spare cartridge		Neutral
	Phase Type 1	Type 2	
<b>PRD1 25r</b>			
PRD1 25r 1P	<b>16315</b>	<b>16316</b>	-
PRD1 25r 1P+N	<b>16315</b>	<b>16316</b>	<b>16317</b>
PRD1 25r 3P	<b>3 x 16315</b>	<b>3 x 16316</b>	-
PRD1 25r 3P+N	<b>3 x 16315</b>	<b>3 x 16316</b>	<b>16317</b>

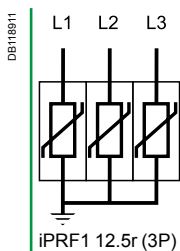

		Earthing system
<b>3P</b>		
		TN-S
<b>A9L16633</b>		TN-C

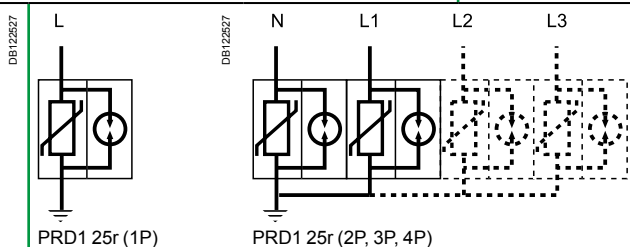

1P	2P	3P	4P	Earthing system
				TN-S
<b>16329</b>	<b>2 x 16329</b>	<b>16331</b>	<b>4 x 16329</b>	TN-C

Type	Nb. of poles	Width modules	I <sub>imp</sub> (kA) (10/350) Impulse current	I <sub>max</sub> (kA) (8/20) Maximum discharge current	In - kA Nominal discharge current	Up - kV Voltage protection level	Un - (V) Rated voltage network	Uc - V Maximum continuous operating voltage	Cat. no.
<b>Fixed surge arrester</b>		<b>9 mm modules</b>						(L-N)/(N-PE)	
<b>iPRF1 12.5r</b>	Type <b>1</b> + <b>2</b>								
	1P+N	4	12.5 (L-N)/50 (N-PE)	50	25	≤ 1.5	230	350/255	<b>A9L16632</b>
	3P	8	12.5	50	25	≤ 1.5	230/400	350	<b>A9L16633</b>
	3P+N	8	12.5 (L-N)/50 (N-PE)	50	25	≤ 1.5	230/400	350/255	<b>A9L16634</b>
<b>Withdrawable surge arrester</b>									
<b>PRD1 25r</b>	Type <b>1</b> + <b>2</b>								
	1P	4	25	40	25	≤ 1.5	230	350	<b>16329</b>
	1P+N	8	25 (L-N)/100 (N-PE)	40	25	≤ 1.5	230	350/350	<b>16330</b>
	3P	12	25	40	25	≤ 1.5	230/400	350	<b>16331</b>
	3P+N	16	25 (L-N)/100 (N-PE)	40	25	≤ 1.5	230/400	350/350	<b>16332</b>
<b>Spare cartridge</b>									
C1 25-350	-	23 mm	-	-	25	≤ 1.5	-	350	<b>16315</b>
C2 40-350	-	12 mm	-	-	20	≤ 1.5	-	350	<b>16316</b>
C1 Neutral-350	-	4	-	-	-	-	-	350	<b>16317</b>

### Technical data

		<b>iPRF1 12.5r</b>	<b>PRD1 25r</b>
Operating frequency		50 Hz	50 Hz
Degree of protection	Front panel	IP40	IP40
	Terminals	IP20	IP20
	Impacts	IK05	IK05
Response time		≤ 25 ns	≤ 25 ns
Short circuit withstand (I <sub>sc</sub> )		50 kA	25 kA
Temporary overvoltage withstand (U <sub>T</sub> )	U <sub>T</sub> (L-N)	335 V AC/5 s	415 V AC/5 s
	U <sub>T</sub> (N-PE)	1200 V AC/200 ms	1200 V AC/200 ms
Temporary overvoltage <b>Safe failure mode</b> (U <sub>T</sub> )	U <sub>T</sub> (L-N)	440 V AC/120 min	440 V AC/120 min
Ground residual current (I <sub>PE</sub> )	I <sub>PE</sub> (N-PE)	0.004 mA	≤ 0.01 mA for 1P+N, 3P+N
Follow current interrupting rating (I <sub>fi</sub> )	I <sub>fi</sub> (L-N)	-	25 kA/264 V AC 3 kA/350 V AC
	I <sub>fi</sub> (N-PE)	100 A	100 A
End-of-life indication		Green: correct operation Red: at end of life	White: correct operation Red: at end of life
	Remote notification	1.5 A/250 V AC	1 A/250 V AC ≤ 1 A/30 V DC
By tunnel terminal	Rigid cable	10...35 mm <sup>2</sup>	10...35 mm <sup>2</sup>
	Flexible cable	10...25 mm <sup>2</sup>	10...25 mm <sup>2</sup>
Operating temperature		-25°C to +60°C	-40°C to +80°C
Humidity range		5 % to 95 %	5 % to 95 %
Standards		IEC 61643-11: 2011 <b>T1</b> , <b>T2</b> EN 61643-11: 2012 Type 1 + Type 2	IEC 61643-11: 2011 <b>T1</b> , <b>T2</b> EN 61643-11: 2012 Type 1 + Type 2
Approvals		CE, EAC	CE, KEMA-KEUR

### Choice of disconnector / surge arrester

Type	I <sub>imp</sub> : impulse current	I <sub>sc</sub> : prospective short-circuit current at the installation point				
		10 kA	15 kA	25 kA	36 kA	50 kA
<b>iPRF1 12.5r</b>	12.5 kA	C120N 80 A curve C or Compact NSX100B 100 A *	C120H 80 A curve C or Compact NSX100B 100 A *	Compact NSX100B 100 A *	Compact NSX100F 100 A *	Compact NSX100N 100 A *
<b>PRD1 25r</b>	25 kA	Compact NSX100B 100 A			-	

(\* ) For lightning impulse current withstand



PE113739-90

### PRD1 25r Reversible

■ The surge arrester base can be turned over to allow the phase/neutral/earth cables to enter through either the top or the bottom



### Dimensions (mm)

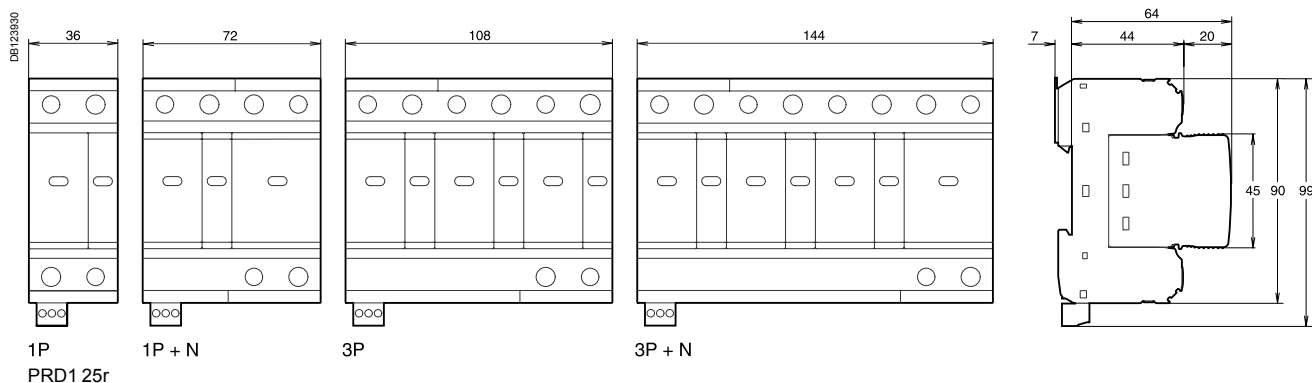
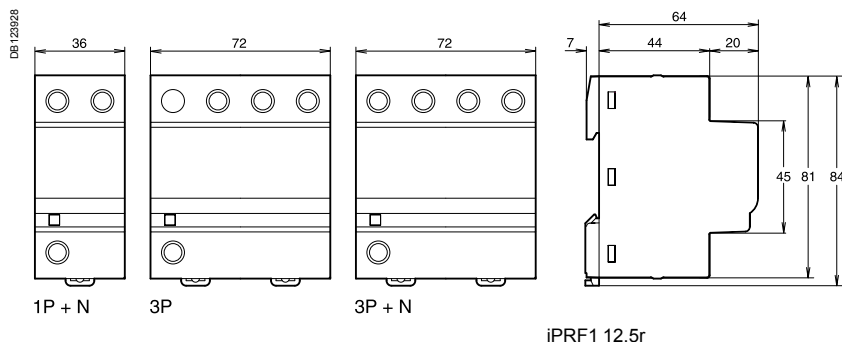

### Weight (g)

Surge arresters		
Type	iPRF1 12,5r	PRD1 25r
1P	-	334
1P+N	290	725
3P	590	1010
3P+N	590	1338
Cartridge		
Neutral	-	229
Phase	-	-

# iPRD surge arresters

## Type 2 or 3 LV withdrawable surge arresters



iPRD withdrawable surge arresters allow quick replacement of damaged cartridges.  
 Type 2 surge arresters are tested with a 8/20 µs current wave.  
 Type 3 surge arresters are tested with a 1.2/50 µs and 8/20 µs combined wave.

Each surge arrester in the range has a specific application:

- **incoming protection (type 2):**
  - the iPRD65r is recommended for a very high risk level (strongly exposed site)
  - the iPRD40(r) is recommended for a high risk level
- **secondary protection (type 2 or 3):**
  - the iPRD8(r) ensures secondary protection of loads to be protected and is placed in cascade with the incoming surge arresters. This surge arrester is required when the loads to be protected are at a distance of more than 10 m from the incoming surge arrester.

The iPRD surge arresters with “r” indication have remote transfer of the information: “cartridge to be replaced”.

### Catalogue number iPRD surge arresters



2P



3P+N

Rated discharge current (Imax)	Nominal discharge current (In)	Type of protection		Network			
				DB1122842		DB1122843	
		Incoming	Secondary	1P+N	3P+N	1P	3P
<b>iPRD65</b>							
65 kA Very high risk level (strongly exposed site)	20 kA	iPRD65				A9L65101	
				A9L65501			
					A9L65601		A9L65301
<b>iPRD40</b>							
40 kA High risk level	15 kA	iPRD40				A9L40101	
				A9L40500			
					A9L40601		A9L40301
<b>iPRD8</b>							
8 kA Secondary protection: placed near the loads to be protected when they are at a distance of more than 10 m from the incoming surge arrester	2.5 kA		iPRD8			A9L08100	
				A9L08501			
					A9L08601		A9L08300

# iPRD surge arresters

## Type 2 or 3 LV withdrawable surge arresters (cont.)



Cartridge

### Spare cartridges iPRD

Type	Spare cartridges for	Cat. no
iPRD 65-350	iPRD65r	A9L65102
iPRD 40-350	iPRD40, iPRD40r	A9L40102
iPRD 8-350	iPRD8, iPRD8r	A9L08102
iPRD Neutral	All products (1P+N, 3P+N)	A9L00002

	Earthing system	Transfer	Surge arrester name	Width in mod. of 9 mm	Up - (kV) Voltage protection level			Un - (V) Rated voltage network	Uc - (V) Maximum continuous operating voltage		
					CM*		DM*		CM*		DM*
					L/±	N/±	L/N		L/±	N/±	L/N
<b>iPRD65</b>											
A9L65101	TN	■	iPRD65r 1P	2	≤ 1.5	-	-	230	350	-	-
A9L65501	TN-S	■	iPRD65r 1P+N	4	-	≤ 1.4	≤ 1.5	-	-	260	350
A9L65301	TN-C	■	iPRD65r 3P	6	≤ 1.5	-	-	230/400	350	-	-
A9L65601	TN-S	■	iPRD65r 3P+N	8	-	≤ 1.4	≤ 1.5	-	-	260	350
<b>iPRD40</b>											
A9L40101	TN	■	iPRD40r 1P	2	≤ 1.6	-	-	230	350	-	-
A9L40500	TN-S	■	iPRD40 1P+N	4	-	≤ 1.4	≤ 1.6	-	-	260	350
A9L40301	TN-C	■	iPRD40r 3P	6	≤ 1.6	-	-	230/400	350	-	-
A9L40601	TN-S	■	iPRD40r 3P+N	8	-	≤ 1.4	≤ 1.6	-	-	260	350
<b>iPRD8 (1) Type 2 / Type 3 (1)</b>											
A9L08100	TN		iPRD8 1P	2	≤ 1.2	-	-	230	350	-	-
A9L08501	TN-S	■	iPRD8r 1P+N	4	-	≤ 1.4	≤ 1.2	-	-	260	350
A9L08300	TN-C	■	iPRD8 3P	6	≤ 1.2	-	-	230/400	350	-	-
A9L08601	TN-S	■	iPRD8r 3P+N	8	-	≤ 1.4	≤ 1.2	-	-	260	350

\* **CM**: common mode (phase to earth and neutral to earth). \* **DM**: differential mode (phase to neutral). (1) **Uoc**: combined waveform voltage: 10 kV.

# iPRD surge arresters

## Type 2 or 3 LV withdrawable surge arresters

### Connection iPRD surge arresters

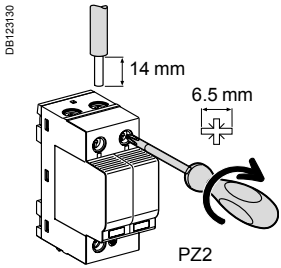

Type	Tightening torque	Copper cables	
		Rigid	Flexible or with ferrule
iPRD	3.5 N.m	2.5 to 25 mm <sup>2</sup>	4 to 16 mm <sup>2</sup>

### Technical data iPRD surge arresters

Main characteristics		iPRD	iPRD IT
Operating frequency		50/60 Hz	
Operating voltage (U <sub>e</sub> )		230/400 V AC ±10 %	
Permanent operating current (I <sub>c</sub> )		< 1 mA	
Response time		< 25 ns	
Short circuit current rating (I <sub>sc</sub> )		50 kA (50 Hz)	-
Short circuit current rating (I <sub>sc</sub> ), case of double fault		-	5 kA (50 Hz)
Temporary overvoltage withstand (U <sub>T</sub> )	U <sub>T</sub> (L-N)	337 V AC / 5 s	337 V AC / 5 s
	U <sub>T</sub> (L-PE)	442 V AC / 120 min	-
Temporary overvoltage	U <sub>T</sub> (N-PE)	1200 V AC / 200 ms	1455 V AC / 200 ms
Safe failure mode (U <sub>T</sub> )	U <sub>T</sub> (L-PE)	1455 V AC / 200 ms	1455 V AC / 200 ms
Ground residual current (I <sub>PE</sub> )	I <sub>PE</sub> (L-PE)	600 µA for 1P, 3P	
	I <sub>PE</sub> (N-PE)	3 µA for 1P+N, 3P+N -	
Satisfactory operation indication: White		In operation	
by mechanical indicator		Red	
Remote indication of satisfactory operation		By contact NO, NC 250 V / 0.25 A	
Additional characteristics			
Degree of protection (IEC 60529)	Device only	IP20 (built-in)	
	Device in modular enclosure	IP40	
Operating temperature		-25°C to +60°C	
Storage temperature		-40°C to +85°C	
Humidity range		5 % to 95 %	
Type of connection terminals		Tunnel terminals, 2.5 to 35 mm <sup>2</sup>	
Standards		IEC 61643-11: 2011 <u>T2</u> , <u>T3</u> and EN 61643-11: 2012 Type 2, Type 3	

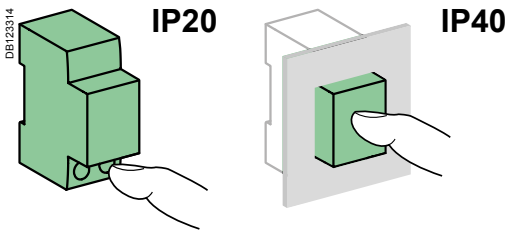

### Surge arrester/circuit breaker association

Surge arrester	Associated circuit breaker		
	iPRD		iPRD IT
	I <sub>sc</sub> ≤ 25 kA	I <sub>sc</sub> ≤ 50 kA	I <sub>sc</sub> (IT 400 V AC) ≤ 5 kA
iPRD65	Curve C 50 A	Curve C 63 A	Curve C 25 A
iPRD40	Curve C 40 A	Curve C 63 A	Curve C 20 A
iPRD8	Curve C 10 A	Curve C 63 A	Curve C 10 A

### iPRD dimensions (mm)

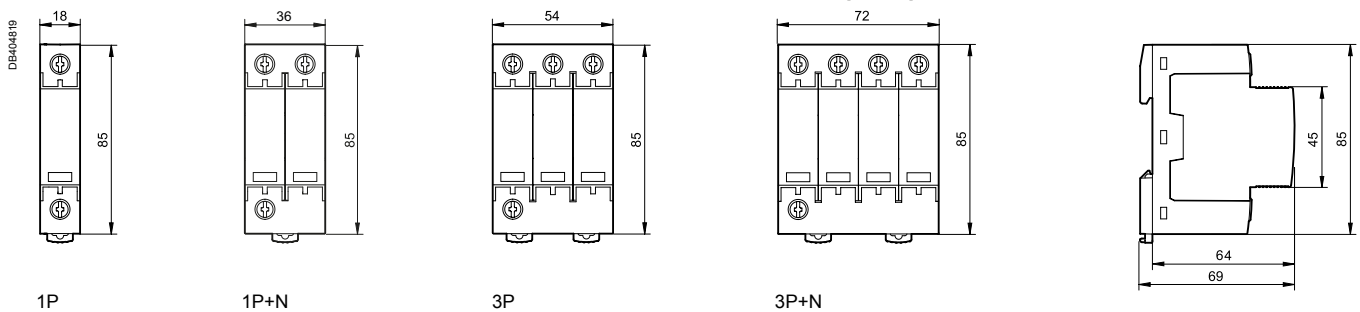

### Weight (g)

Surge arrester	
Type	iPRD
1P	119
1P+N	220
3P	340
3P+N	450

# iPRD surge arresters

## Type 2 or 3 LV withdrawable surge arresters (cont.)

### iPRD surge arresters

PB110281-80

**Satisfactory operation indication**  
 ■ By mechanical indicator  
 □ white: operating  
 □ red: cartridge must be replaced



### Connection iPRD surge arrester with its short circuit disconnecter

#### TN-S

Power supply through the top  
Connection with cables

PB110289-50



Surge arrester iPRD 3P+N + iC60N 3P+N

**Reversible**  
 ■ The surge arrester base can be turned over to allow the phase/neutral/earth cables to enter through either the top or the bottom

#### TN-S

Power supply through the bottom  
Connection with comb busbar

PB110783-50



Surge arrester iPRD 3P+N + iC60N 3P+N

PB110287-50

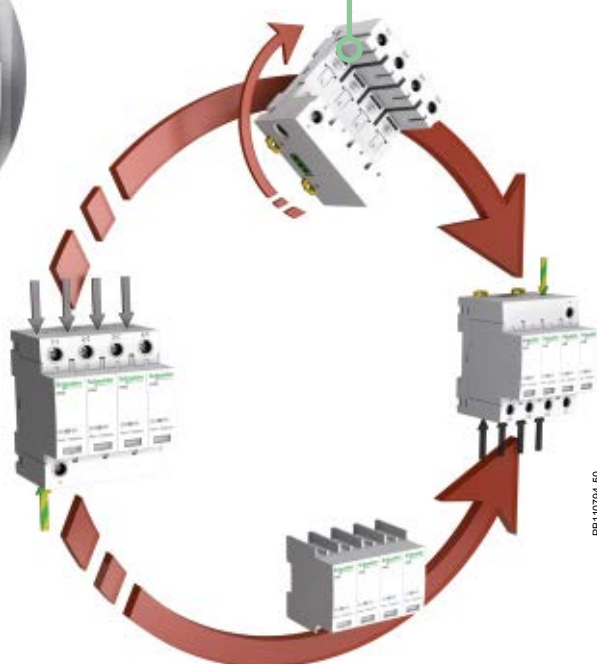

#### TNC

Power supply through the bottom  
Connection with comb busbar

PB110794-50



Surge arrester iPRD 3P+N + iC60N 3P+N

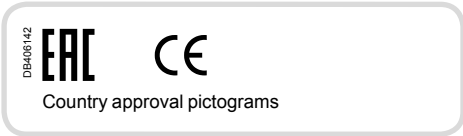

Each surge arrester in the range has a specific application:  
**■ incoming protection (type 2):**  
 the iPF K 20 is recommended for a medium risk level.

The iPF K multi-pole single-piece surge arrester range is adapted for earthing systems: TT, TN-S, TN-C.  
 Type 2 surge arresters are tested with a 8/20 μs current wave.



1P

Rated discharge current (I <sub>max</sub> ) / Nominal discharge current (I <sub>n</sub> )	Type of protection	Network			
		1P+N	3P+N	1P	3P
20 kA / 5 kA	Incoming				
Medium risk level	iPF K 20	A9L15692		A9L15691	A9L15597
			A9L15693		



1P+N



3P



3P+N

### Cartridges

Surge arrester/circuit breaker association	
Type of surge arrester	Associated circuit breaker (1 to 4 poles protected) (I <sub>sc</sub> ≤ 6 kA)
iPF K 20	iK60N Curve C 20 A

### Connection

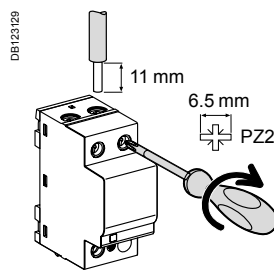

Type	Tightening torque	Copper cables	
		Rigid	Flexible or with ferrule
iPF K	3.5 N.m	 25 mm <sup>2</sup> max.	 16 mm <sup>2</sup> max.

Earthing system	Surge arrester name	Width in mod. of 9 mm	Up - (kV) Voltage protection level			Un - (V) Rated voltage network	Uc - (V) Maximum continuous operating voltage		
			CM*		DM*		CM*		DM*
			L/≐	N/≐	L/N		L/≐	N/≐	L/N
<b>iPF K 20</b>									
TN	iPF K 20 1P	2	≤ 1.1	-	-	230	340	-	-
TN-S	iPF K 20 1P+N	4	-	≤ 1.5	≤ 1.1	-	-	260	340
TN-C	iPF K 20 3P	8	≤ 1.1	-	-	230/400	340	-	-
TN-S	iPF K 20 3P+N	-	-	≤ 1.5	≤ 1.1	-	-	260	340

\* **CM**: common mode (phase to earth and neutral to earth). \* **DM**: differential mode (phase to neutral). (1) **Uoc**: combined waveform voltage: 10 kV.

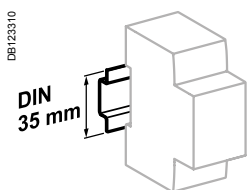

Clip on DIN rail 35 mm.

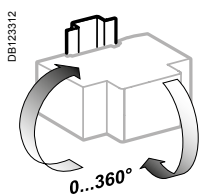

Indifferent position of installation.

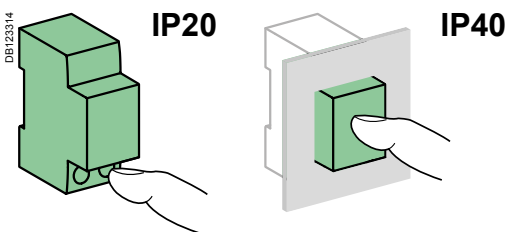

### Technical data

Main characteristics		
Operating frequency	50/60 Hz	
Rated voltage network (Un)	230/400 V AC ±10 %	
Permanent operating current (Ic)	< 5 mA	
Response time	< 25 ns	
Short circuit withstand (I <sub>SCCR</sub> )	25 kA (50 Hz)	
Temporary overvoltage withstand (U <sub>T</sub> )	LV network	U <sub>T</sub> (L-N) 337 V AC / 5 s
		U <sub>T</sub> (L-PE) 442 V AC / 120 min
Temporary overvoltage withstand (U <sub>T</sub> )	HV network	U <sub>T</sub> (N-PE) 1200 V AC / 200 ms
		U <sub>T</sub> (L-PE) 1453 V AC / 200 ms
Ground residual current (I <sub>PE</sub> )	I <sub>PE</sub> (L-PE)	1P: ≤ 5 mA
		3P: ≤ 25 mA
	I <sub>PE</sub> (N-PE)	3 μA for 1P+N, 3P+N
Operation indication by mechanical indicator	Green	In operation
	Red	At end of life
Additional characteristics		
Degree of protection (IEC 60529)	Device only	IP20 (built-in)
	Device in modular enclosure	IP40
Operating temperature	-25°C to +60°C	
Humidity range	5 % to 95 %	
Standards	IEC 61643-11: 2011 T2	

### Dimensions (mm)

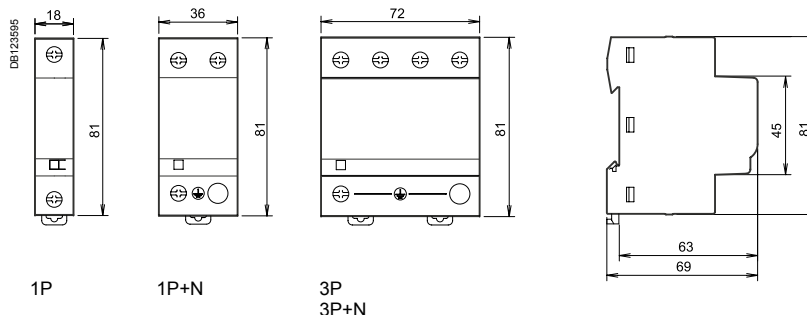

### Weight (g)

Surge arrester	
Type	iPF K
1P	125
1P+N	210
3P	335
3P+N	420

# iPRD-DC surge arresters

## Withdrawable surge arresters type 2 for photovoltaic applications



Country approval pictograms

IEC 61643-1 **T2**  
 EN 61643-11 Type 2  
 UTE C 61740-51 **T2**  
 prEN 50539-11 **T2**



iPRD-DC40r 600PV

iPRD-DC direct current surge arresters are designed to protect against overvoltages due to a lightning strike: of the "DC" input to the inverter and of photovoltaic panels.

It should be installed in a switchboard inside the building. If the switchboard is located outside, it must be weatherproof.

Withdrawable iPRD-DC surge arresters allow damaged cartridges to be replaced quickly. They offer remote reporting of the "cartridge must be changed" message.

### Catalogue numbers

Internal diagram	Imax (kA) Maximum discharge current	In (kA) Nominal discharge current	Up (kV) Protection level			U <sub>CPV</sub> (V) <sup>(1)</sup> Maximum steady state voltage			Width in module of 9 mm	Cat. no.
			L+/ $\neq$	L-/ $\neq$	L+/L-	L+/ $\neq$	L-/ $\neq$	L+/L-		
<b>iPRD-DC40r 600PV</b>										
	40	15	1.6	1.6	2.8	600	600	840	6	<b>A9L16434</b>
<b>iPRD-DC40r 1000PV</b>										
	40	15	3.9	3.9	3.9	1000	1000	1000	6	<b>A9L16436</b>

(1) U<sub>cpv</sub> ≥ 1.2 x U<sub>oc stc</sub> (U<sub>oc stc</sub>: maximum no-load voltage of the photovoltaic generator "photovoltaic module manufacturer's data")



Replacement cartridges

### Replacement cartridges

Type	Replacement cartridges for	Cat. no.
C 40-600PV	iPRD-DC40r 600PV	<b>A9L16683</b>
C 40-1000PV	iPRD-DC40r 1000PV	<b>A9L16692</b>
C neutral PV	iPRD-DC40r 600PV	<b>A9L16690</b>



# iPRD-DC surge arresters

Withdrawable surge arresters type 2 for photovoltaic applications (cont.)

## Connection

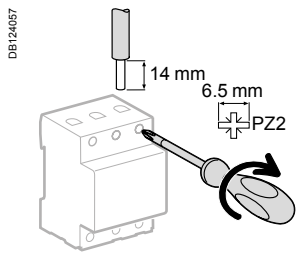

Type	Tightening torque	Copper cables	
		Rigid	Flexible or with ferrule
iPRD-DC	2 N.m	2.5 to 25 mm <sup>2</sup>	2.5 to 16 mm <sup>2</sup>

Depending on the distance between the "generator" part and the "conversion" part, it may be necessary to install two surge arresters or more, to ensure protection of each of the two parts.

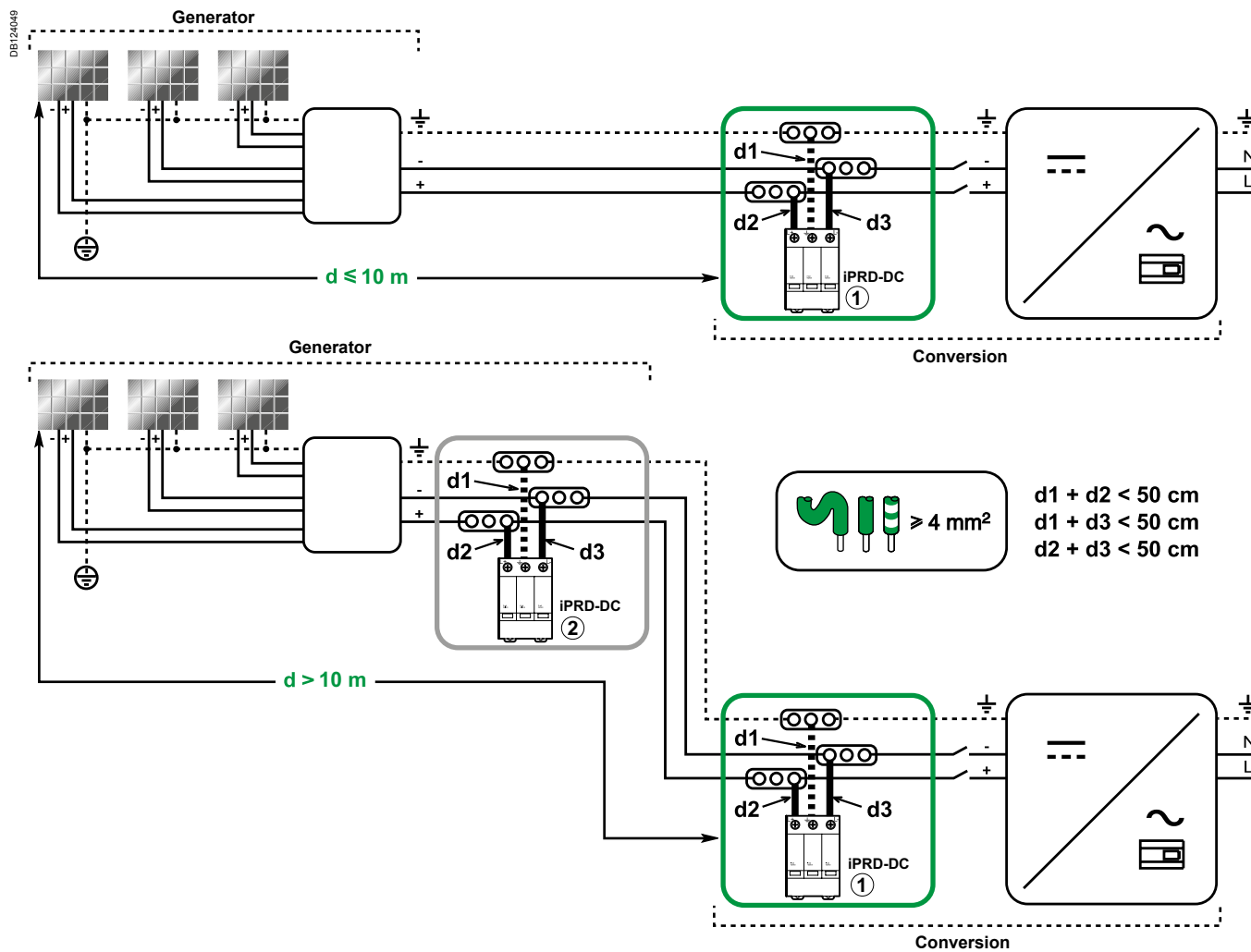

# iPRD-DC surge arresters

## Withdrawable surge arresters type 2 for photovoltaic applications (cont.)

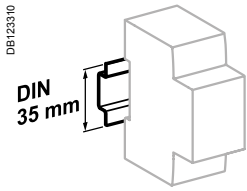

Clip on DIN rail 35 mm.

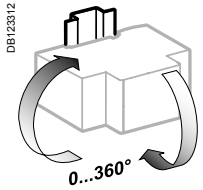

Indifferent position of installation.

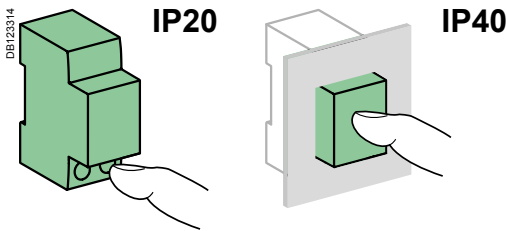

### Technical data

Main characteristics			
Type of network	Isolated direct current		
Temps de réponse	< 25 ns		
Short circuit current ( $I_{SCP}$ )	30 A		
Type of surge arresters	Type 2		
End-of-life indication mode	Circuit opened by integrated thermal disconnecter		
Additional characteristics			
Degree of protection (IEC 60529)	Device only	IP20	
	Device in modular enclosure	IP40	
	Chocs	IK03	
End-of-life indication	By the cartridges	White	Operational
		Red	At end of life
		By the NO/NC remote indication contact 250 V AC / 0.25 A	
Operating temperature	-25°C to +60°C		
Storage temperature	-40°C to +85°C		
Tropicalization (IEC 60068-1)	Treatment 2 (relative humidity of 95 % at 55°C)		

### Weight (g)

Surge arresters	
Type	
iPRD-DC40r 600PV	400
iPRD-DC40r 1000PV	400

### Dimensions (mm)

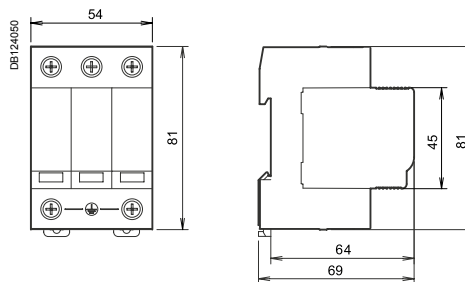

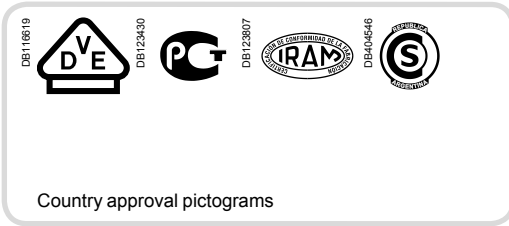

## IEC/EN 60947-3

The switch-disconnectors combine the following functions:

- Control (opening and closing of circuits under load).

### iOF auxiliary

- Mounted on the left, it indicates the "open" or "closed" position of the switch and has a normally open (NO) or normally closed (NC) contact.



1P



3P



4P

## Catalogue numbers

40 to 125 A iSW switch-disconnectors				
Type				Width in 9 mm modules
<b>1P</b>	<b>Rating</b>	<b>Voltage (Ue)</b>		
DB118998 1 2	40 A	240 V AC	<b>A9S65140</b>	2
<b>3P</b>				
DB119000 1 3 5 2 4 6	40 A 63 A	415 V AC 415 V AC	<b>A9S65340</b> <b>A9S65363</b>	6
<b>4P</b>				
DB119001 1 3 5 7 2 4 6 8	40 A	415 V AC	<b>A9S65440</b>	8
Operating frequency		50/60 Hz		
Accessories		See page 94		



PB104474-35

Auxiliary			
Type			Width in 9 mm modules
<b>iOF</b>	<b>Voltage (Ue)</b>		
DB118910 14 12 11	240...415 V AC 24...130 V DC	<b>A9A26924</b>	1

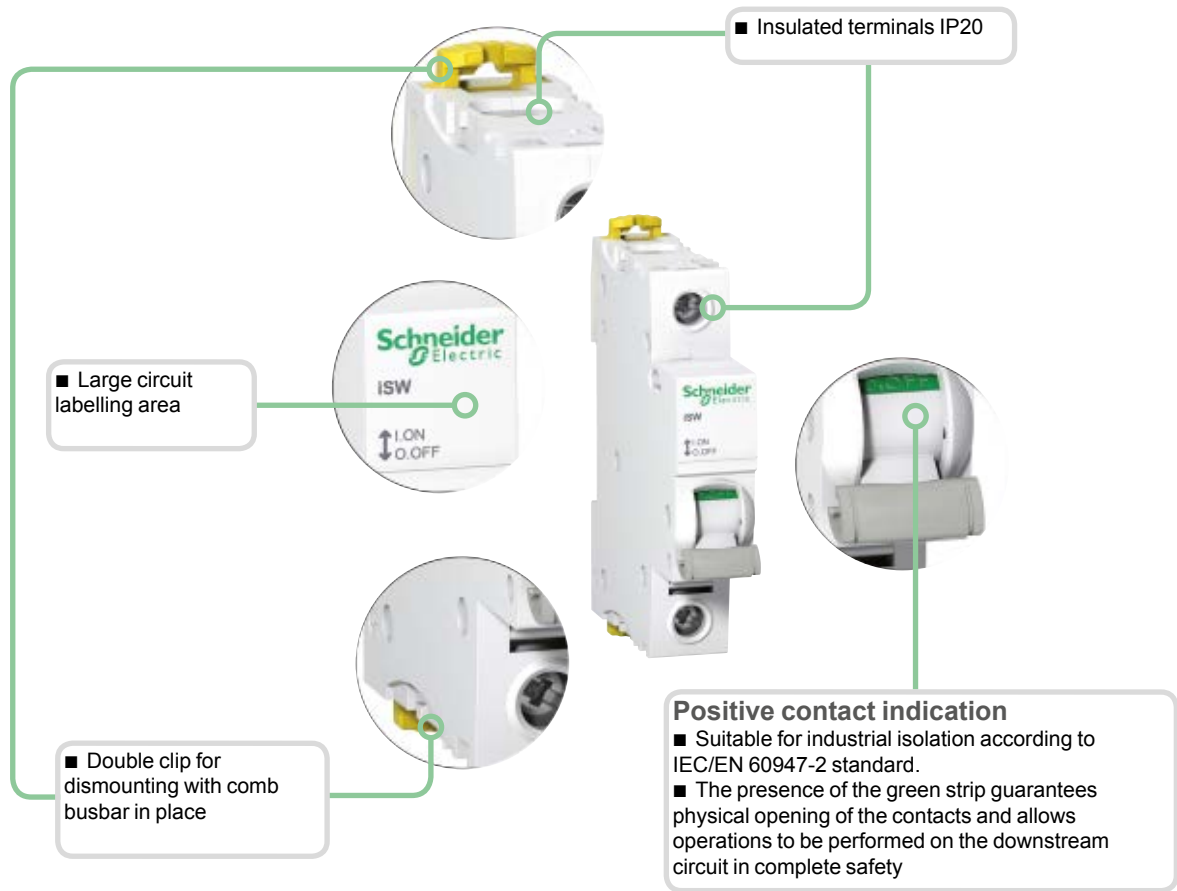

## Dimensions (mm)

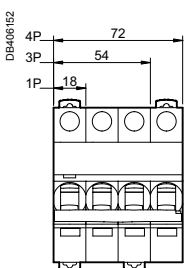

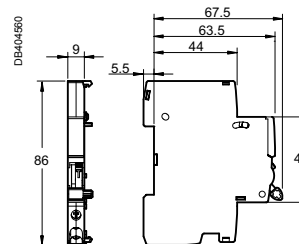
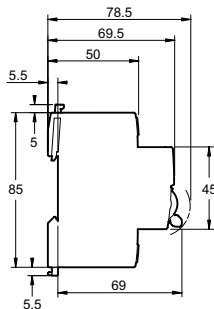

iSW





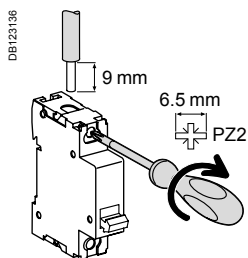

iOF

## Connection

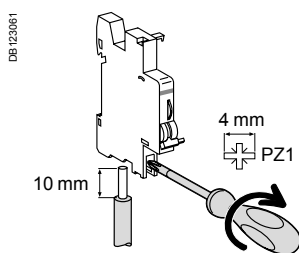

Type	Rating	Tightening torque	Copper cables	
			Rigid	Flexible or with ferrule
iSW	40 to 125 A	3.5 N.m	 $\leq 50 \text{ mm}^2$	 $\leq 35 \text{ mm}^2$



Type	Tightening torque	Copper cables		Multi-cables terminal	
		Rigid	Flexible	Rigid cables	Cables with ferrule
iOF	1 N.m	 1 to 4 mm <sup>2</sup>	 0.5 to 2.5 mm <sup>2</sup>	 2 x 2.5 mm <sup>2</sup>	 2 x 1.5 mm <sup>2</sup>

## Technical data

### Main characteristics

Insulation voltage (Ui)	1P: 250 V AC 2P, 3P, 4P: 500 V AC
Pollution degree	3

### Power circuit

Rated impulse withstand voltage (Uimp)	6 kV
Operating category	AC - 22A
Permissible rated short-time withstand current (Icw)	1500 A
Conditional rated short-circuit current (Inc)	10 kA according to IEC 60947-3
Rated short-circuit closing current (Icm)	5 kA

### Additional characteristics

Degree of protection	Device only	IP20						
	Device in modular enclosure	IP40						
Endurance (O-C)	Mechanical	20,000 cycles						
		Electrical	<table border="1"> <tr> <td>40 A - 63 A</td> <td>15,000 cycles</td> </tr> <tr> <td>80 A - 100 A</td> <td>10,000 cycles</td> </tr> <tr> <td>125 A</td> <td>2 500 cycles</td> </tr> </table>	40 A - 63 A	15,000 cycles	80 A - 100 A	10,000 cycles	125 A
	40 A - 63 A	15,000 cycles						
	80 A - 100 A	10,000 cycles						
125 A	2 500 cycles							
Operating temperature	-25°C to +60°C							
Storage temperature	-40°C to +85°C							
Tropicalization	Treatment 2 (relative humidity 95% at 55°C)							

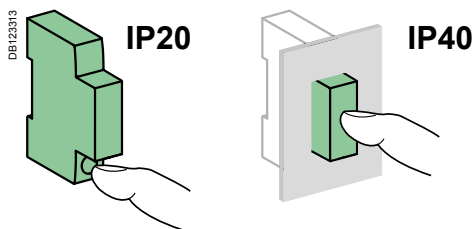

### iOF characteristics

Rated voltage (Ue)	240...415 V AC	
	24...130 V DC	
Operating frequency	50/60 Hz	
Operating current	24 V DC	6 A
	48 V DC	2 A
	60 V DC	1.5 A
	130 V DC	1 A
	240 V AC	6 A
	415 V AC	3 A
Number of contacts	1 NO/NC	
Operating temperature	-35°C to +70°C	
Storage temperature	-40°C to +85°C	

### Position contact indication

- Suitable for industrial isolation according to IEC/EN 60947-3 standard.
- The presence of the green strip guarantees physical opening of the contacts and allows operations to be performed on the downstream circuit in complete safety.



### IEC/EN 60669-1, iSW switch with indicator light. IEC/EN 60669-2-4, iSW switch without indicator light.

These switches are used for:

- Control (opening and closing of circuits under load).
- Disconnection, for switches without indicator light IEC/EN 60669-2-4.

### OF iSW auxiliary

- Mounted on the left, it indicates the "open" or "closed" position of the switch and has a normally open (NO) or normally closed (NC) contact.



Control switches



### Catalogue numbers

20, 32 A iSW control switches				
Type	Rating	Voltage (Ue)		Width in 9 mm modules
1P DB118918	20 A	250 V AC	A9S60120	2
	32 A	250 V AC	A9S60132	
2P DB118959	20 A	250 V AC	-	2
		415 V AC	A9S60220	
	32 A	250 V AC	-	2
		415 V AC	A9S60232	
3P DB119000	20 A	415 V AC	A9S60320	4
	32 A	415 V AC	A9S60332	
4P DB119001	20 A	415 V AC	A9S60420	4
	32 A	415 V AC	A9S60432	
Operating frequency			50/60 Hz	
Accessories			See page 100	



Control switches with indicator light

## Catalogue numbers (cont.)

### 20, 32 A iSW control switches with indicator light

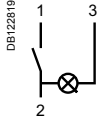
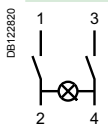
Type			Width in 9 mm modules
<b>1P</b> 	Rating	230 V indicator light	2
	20 A	A9S61120	
	32 A	A9S61132	
<b>2P</b>			
	20 A	A9S61220	2
	32 A	A9S61232	
Operating frequency		50/60 Hz	
Accessories		See page 100	

### Spare indicator lights for 20, 32 A iSW switches

Type		
Neon	Voltage (Ue)	15111
Supplied with a red diffuser (Pack of 10)	230 V AC	



OF iSW

## Catalogue numbers (cont.)

### Auxiliary

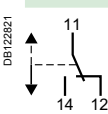
Type			Width in 9 mm modules
<b>OF iSW</b> 	Rating	Voltage (Ue)	2
	3 A	415 V AC	
	6 A	250 V AC	

## Connection

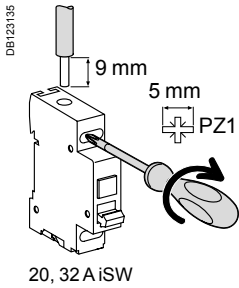

Type	Rating	Tightening torque	Copper cables	
			Rigid	Flexible or with ferrule
iSW	<b>20, 32 A</b>	1.2 N.m	DB122945 10 mm <sup>2</sup>	DB122946 10 mm <sup>2</sup>
OF iSW	-	1.2 N.m	10 mm <sup>2</sup>	10 mm <sup>2</sup>

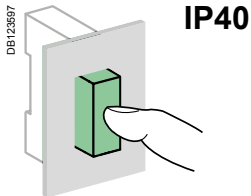

## Technical data

Main characteristics		20, 32 A iSW	
Insulation voltage (Ui)		<b>Without indicator light</b> ■ 1P: 250 V AC ■ 2P, 3P, 4P: 500 V AC	<b>With indicator light</b> 250 V AC
Pollution degree		2	
Power circuit			
Rated impulse withstand voltage (Uimp)		4 kV	
Operating category		AC - 22 A	
Conditional rated short-circuit current (Isc)		3 kA to IEC/EN 60669-2-4	
Additional characteristics			
Degree of protection		IP40 on the front panel	
Endurance (O-C)	Mechanical	300,000 cycles	
	Electrical	30,000 cycles	
Operating temperature		-20°C to +50°C	
Storage temperature		-40°C to +70°C	
Tropicalization		Treatment 2 (relative humidity 95% at 55°C)	

## Dimensions (mm)

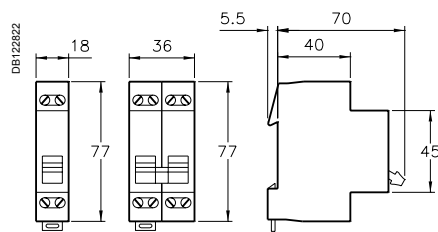

1P, 2P    3P, 4P  
20, 32 A iSW

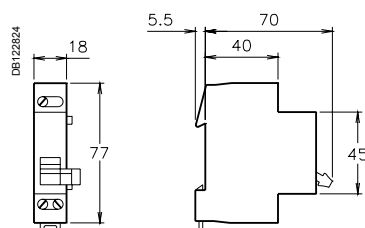



OF iSW





IEC 60669-1 and IEC 60947-5-1

■ iSSW linear switches are used for the manual control of electric circuits.

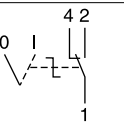
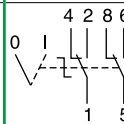
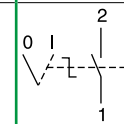
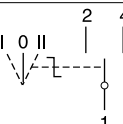
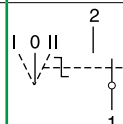
## Catalogue numbers

iSSW linear switches					
Type	2 positions			3 positions	
					
Contact	1 changeover switch	2 changeover switches	1 NO + 1NC	1 changeover switch	2 changeover switches
Diagram					
Cat. no.	A9E18070	A9E18071	A9E18072	A9E18073	A9E18074
Width in 9 mm modules	2	4	2	2	4

## Connection

Tightening torque	Copper cables	
	Rigid	Flexible or with ferrule
1 N.m	 DB1225H5	 DB1225H6
	0.5 mm <sup>2</sup> min. 2 x 2.5 mm <sup>2</sup> max.	0.5 mm <sup>2</sup> min. 2 x 2.5 mm <sup>2</sup> max.

- Phase-separated wall that can be divided to allow the teeth of all types of comb busbar to pass through.
- Staggered terminals to simplify connection.

## Dimensions (mm)

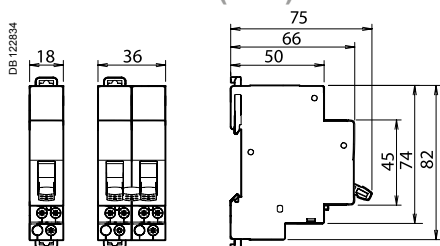

## Technical data

Main characteristics	
Pollution degree	3
Power circuit	
Voltage rating (Ue)	250 V AC
Current rating (Ie)	20 A
Additional characteristics	
Endurance (O-C)	30,000 cycles AC22 (cos φ = 0.8)
Operating temperature	-20°C... +50°C
Storage temperature	-40°C... +70°C
Tropicalization	Treatment 2 (relative humidity 95 % at 55°C)

# iSW-NA switch-disconnector remote tripping

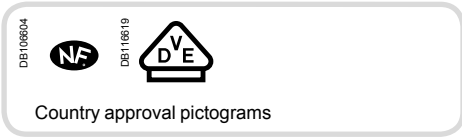

## IEC/EN 60947-3

The iSW-NA trip switch-disconnector combine the following functions:

- control (opening and closing of circuits under load)
- isolation.

It is designed for switchboard or cubicle incoming units in the tertiary and industry sectors, with the possibility of remote tripping via a coil.

### Positive break indication

- Suitability for isolation in the industrial sector to IEC/EN 60947-3.
- The presence of the green strip guarantees that the contacts open physically and allows work to be carried out safely on the downstream circuit.



## Catalogue number

iSW-NA			
Type			Width in 9 mm modules
3P+N	Rating		
DB119001 	40 A	<b>A9S70740</b>	8
Voltage rating (Ue)		400-415 V AC	
Operating frequency		50/60 Hz	
<b>Auxiliaries*</b>		<b>See page 21</b>	
<b>Accessories</b>		<b>See page 94</b>	

\* Electrical auxiliaries must be installed to the left of the switch-disconnector. The iSD auxiliary contact must be combined with an auxiliary device (iMN, iMX, iMX+OF): it indicates that the switch-disconnector has been tripped open..

# iSW-NA switch-disconnector remote tripping(cont.)

## Connection

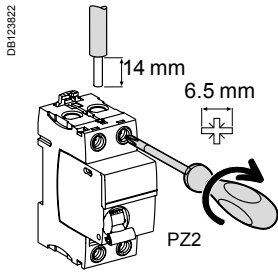

Type	Tightening torque	Without accessory		With accessories			
		Copper cables		50 mm <sup>2</sup> Al terminal	Screw-on connection for ring terminal	Multi-cables terminal	
		Rigid	Flexible or with ferrule			Rigid cables	Flexible cables
iSW-NA	3.5 N.m	DB122945 1 to 35 mm <sup>2</sup>	DB122946 1 to 25 mm <sup>2</sup>	DB122935 50 mm <sup>2</sup>	DB118789 Ø 5 mm	DB118787 3 x 16 mm <sup>2</sup> / 3 x 10 mm <sup>2</sup>	

## Technical data

### Main characteristics

According to IEC 60947-3

Insulation voltage (Ui)	500 V AC
Pollution degree	3
Rated impulse withstand voltage (Uimp)	6 kV
Operating category	AC22A
Permissible rated short-time withstand current (Icw)	20 In/1s
Rated short-circuit making (Icm)	5 kA
Conditional rated short circuit current (Inc/IΔc)	With iC60N/H/L With fuse
	Equal to breaking capacity of iC60 6000 A

### Additional characteristics

Degree of protection	Device only	IP20
	Device in modular enclosure	IP40 Insulation class II
Endurance (O-C)	Electrical	15,000 cycles
	Mechanical	20,000 cycles
Operating temperature		-35°C to +70°C
Storage temperature		-40°C to +85°C
Tropicalization		Treatment 2 (relative humidity 95 % at 55°C)

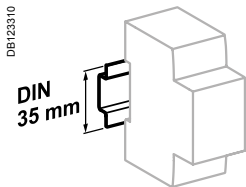

Clip on DIN rail 35 mm.

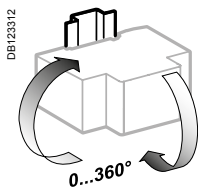

Indifferent position of installation.

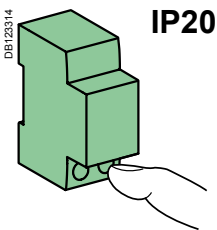

IP20

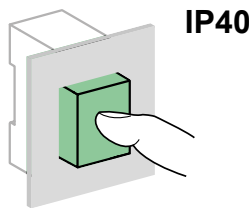

IP40

## Dimensions (mm)

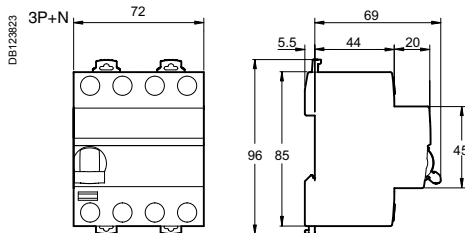

## Weight (g)

### Switch-disconnectors







Type	iSW-NA
3P+N	300

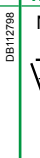

STI	Cartridges
IEC/EN 60947-3, IEC/EN 60269-2	IEC 60269-1, IEC 60269-2, NF C 60-200-2

- The STI isolatable fuse-carriers provide overload and short-circuit protection.
  - They are used for industrial applications requiring a high breaking capacity.
  - They perform the isolation function and must not be used as switches.
  - To be equipped with aM or gG (gL - gI) type fuse cartridge without striker, with or without fuse blowing indicator.
  - Isolation of all poles is guaranteed for the 2P, 3P, and 3P+N versions during factory assembly.
- The general purpose fuse (**gG fuse**) provides overload and short-circuit protection. The fuse for motor application (**aM fuse**) only provides short-circuit protection. It is used for protection of loads with a high peak current (motors, transformer primaries, etc.).

## Catalogue numbers

Fuse cartridge (Type F)						STI fuse holder					
Type	Rating	Voltage rating (Ue)	Short-circuit current (Isc)				Network type				
			aM	gG	aM	gG	1P	1P+N <sup>(1)</sup>	2P	3P	3P+N <sup>(1)</sup>
 8.5 x 31.5 mm	2 A	400 V AC	20 kA	20 kA	DF2BA0200	DF2BN0200	 DB112797	 DB112796	 DB112799	 DB112800	 DB110801
	4 A	400 V AC	20 kA	20 kA	DF2BA0400	DF2BN0400					
	6 A	400 V AC	20 kA	20 kA	DF2BA0600	DF2BN0600					
	8 A	400 V AC	20 kA	20 kA	DF2BA0800	DF2BN0800					
	10 A	400 V AC	20 kA	20 kA	DF2BA1000	DF2BN1000					
10.3 x 38 mm	2 A	500 V AC	120 kA	120 kA	DF2CA02	DF2CN02	A9N15636	A9N15646	A9N15651	A9N15656	A9N15658
	4 A	500 V AC	120 kA	120 kA	DF2CA04	DF2CN04					
	6 A	500 V AC	120 kA	120 kA	DF2CA06	DF2CN06					
	10 A	500 V AC	120 kA	120 kA	DF2CA10	DF2CN10					
	16 A	500 V AC	120 kA	120 kA	DF2CA16	DF2CN16					
	20 A	500 V AC	-	120 kA	-	DF2CN20					
	25 A	500 V AC	-	120 kA	-	DF2CN25					

(1) The neutral pole comes equipped with a locked tube.

### 230 V neon indicator light (Option)

- Indicates fuse blowing (off in normal operation and lit red after fuse blowing)
- 400 V maxi

### Padlocking device

- Locks the toggle in the "open" or "closed" position. Used with an 8 mm max. diameter padlock (not supplied):
  - only one padlock for 1P, 1P+N and 2P products (on the left pole)
  - and two padlock on the 3P and 3P+N products (on every extremity)

### 1P+N, 3P+N

- Phase opening causes compulsory opening of the neutral
- The phase opens before the neutral on isolation and closes after the neutral on circuit closing
- Small dimensions
  - 1P+N in 18 mm
  - 3P+N in 54 mm

### Clip-on markers

- Used to identify:
  - either on the front face
  - or on the downstream terminals

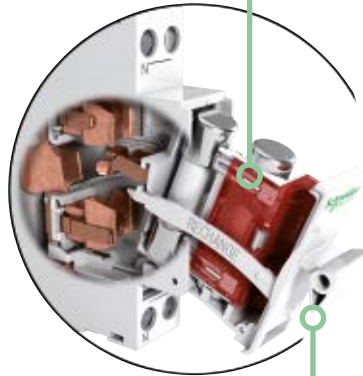

### Fuse-carrier

- Captive
- Additional housing is provided for a spare fuse

## Connection

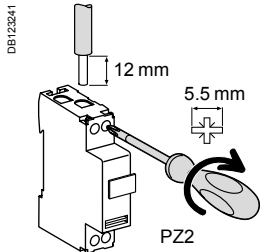

Type	Rating	Tightening torque	Without accessory		With accessories
			Copper cables		Screw-on connection for ring terminal
			Rigid	Flexible or with ferrule	
STI	All	2 N.m	DB1122045  0.75 to 10 mm <sup>2</sup> 2 x 0.75 mm <sup>2</sup> to 2 x 4 mm <sup>2</sup>	DB1122046  0.5 to 6 mm <sup>2</sup> 2 x 0.5 mm <sup>2</sup> to 2 x 4 mm <sup>2</sup>	DB110709  Ø 5 mm

1 Screw-on connection for ring terminal **27053**

## Mounting accessories

2	Padlocking device		<b>15669</b>
3	Neon indicator light	1 piece blister	<b>15668</b>
4	Clip-on terminal markers		<b>See page 97</b>

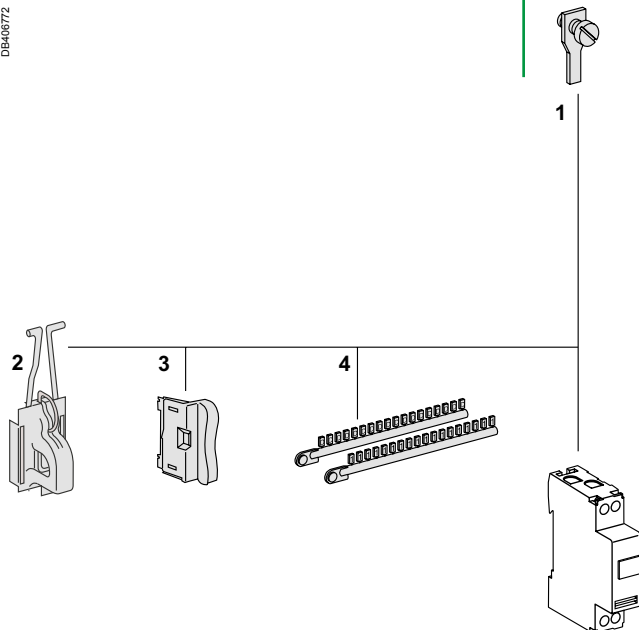

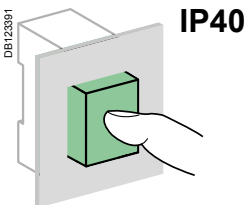
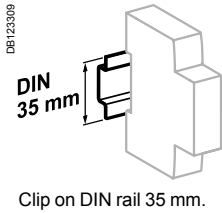

## Technical data

### Main characteristics

Insulation voltage (Ui)	500 V
Breaking capacity according to IEC 60269-2 $\leq 400$ V	50 kA
Pollution degree	3
Operating frequency (Hz)	50/60

### Additional characteristics

Degree of protection	Device in modular enclosure	IP40
		Insulation class II
Operating temperature		-20°C to +60°C
Storage temperature		-40°C to +80°C

### Maximum dissipated power per pole of STI isolatable fuse-carriers

Fuse cartridge type	I <sub>th</sub>	P <sub>max</sub>	
8.5 x 31 mm	aM	10 A	2.5 W
	gG	20 A	2.5 W
10.3 x 38 mm	aM	16 A	3 W
	gG	25 A	3 W

### Maximum dissipated power per fuse cartridges

Fuse cartridge type	I <sub>th</sub>	P <sub>max</sub>	
8.5 x 31 mm	aM	2 to 10 A	0.9 W
	gG	2 to 10 A	2.5 W
10.3 x 38 mm	aM	2 to 25 A	1.2 W
	gG	2 to 25 A	3 W

## Dimensions (mm)

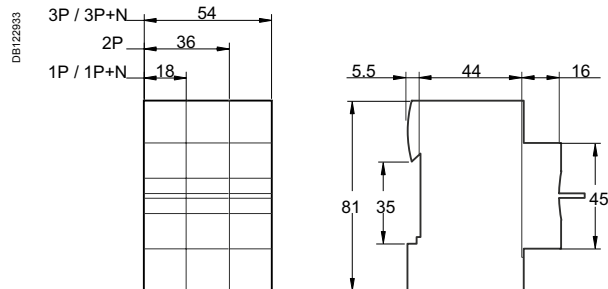

STI

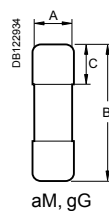

### aM, gG fuse cartridge

Type	A	B	C
8.5 x 31.5 mm	8.5	31.5	10.3
10.3 x 38 mm	10.3	38	10.5

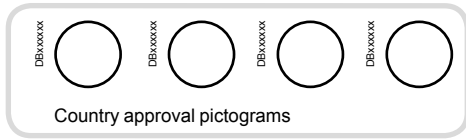

IEC EN 60947-3



MGN15707

- SBI fuse holders provide overload and short-circuit protection.
  - They are used for industrial applications requiring a high breaking capacity.
  - They perform the isolation function and must not be used as switches.
  - They are equipped with an indicator light indicating blowing of the fuse cartridge: to be equipped with aM or gG (gL-gI) type fuse cartridge without striker.
- The general purpose fuse (gG fuse) provides overload and short-circuit protection. The fuse for motor application (**aM fuse**) only provides short-circuit protection. It is used for protection of loads with a high peak current (motors, transformer primaries, etc.).

## Catalogue numbers

Fuse cartridge						SBI fuse holder				
Type	Rating	Voltage rating (Ue)	Short-circuit current (Isc)				Network type			
			aM	gG	aM	gG	1P	1P+N <sup>(1)</sup>	2P	3P
14 x 51 mm	10 A	690 V CA	120 kA	120 kA	DF2EA10	DF2EN10	MGN15707	MGN15709	MGN15710	MGN15711
	12 A	690 V CA	120 kA	-	DF2EA12	-				
	16 A	690 V CA	120 kA	120 kA	DF2EA16	DF2EN16				
	20 A	690 V CA	120 kA	120 kA	DF2EA20	DF2EN20				
	25 A	690 V CA	120 kA	120 kA	DF2EA25	DF2EN25				
	32 A	500 V CA	120 kA	120 kA	DF2EA32	DF2EN32				
	40 A	500 V CA	120 kA	120 kA	DF2EA40	DF2EN40				
	50 A	400 V CA	120 kA	120 kA	DF2EA50	DF2EN50				
22 x 58 mm	32 A	690 V CA	80 kA	80 kA	DF2FA32	DF2FN32	MGN15713	MGN15715	MGN15716	MGN15717
	40 A	690 V CA	80 kA	80 kA	DF2FA40	DF2FN40				
	50 A	690 V CA	80 kA	80 kA	DF2FA50	DF2FN50				
	63 A	690 V CA	80 kA	80 kA	DF2FA63	DF2FN63				
	80 A	690 V CA	80 kA	80 kA	DF2FA80	DF2FN80				
	100 A	400 V CA	120 kA	120 kA	DF2FA100	DF2FN100				
	125 A	400 V CA	120 kA	-	DF2FA125	-				
Operating frequency: 50/60 Hz										

(1) The neutral pole comes equipped with a locked tube.

## Connection

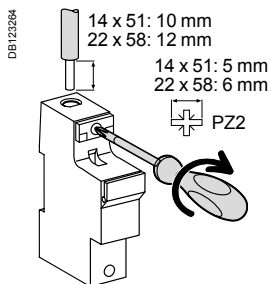

Type of fuse cartridge	Tightening torque	Copper cables		Multi-cables terminal	
		Rigid	Flexible or with ferrule	Rigid cables	Flexible cables
14 x 51 mm	3.5 N.m	2.5 to 25 mm <sup>2</sup>	2.5 to 25 mm <sup>2</sup>	2.5 to 10 mm <sup>2</sup>	2.5 to 10 mm <sup>2</sup>
22 x 58 mm	3.5 N.m	2.5 to 35 mm <sup>2</sup>	2.5 to 35 mm <sup>2</sup>	2.5 to 25 mm <sup>2</sup>	2.5 to 16 mm <sup>2</sup>

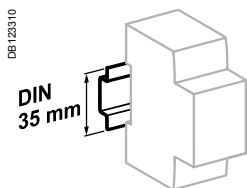

Clip on DIN rail 35 mm.

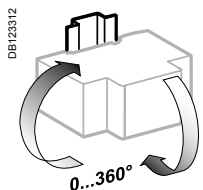

Indifferent position of installation.

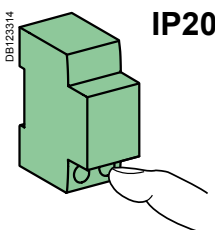

IP20

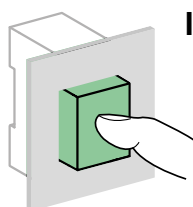

IP40

## Technical data

### Main characteristics

Insulation voltage (Ui)	690 V
Utilization category	AC20B isolation by switching the drawer, must not be operated under load

### Additional characteristics

Degree of protection	Device only	IP20
	Device in modular enclosure	IP40
Operating temperature	-20°C to +60°C	
Storage temperature	-40°C to +80°C	
Cartridge blowing signalling	By indicator light ON (neon)	

Maximum permissible characteristics of the fuse cartridges:

Fuse cartridge type		I <sub>th</sub>	P <sub>max</sub> *
14 x 51 mm	aM	50 A	3 W
	gG	50 A	5 W
22 x 58 mm	aM	125 A	9.5 W
	gG	100 A	9.5 W

\*P<sub>max</sub>: maximum dissipated power per fuse cartridge.

## Dimensions (mm)

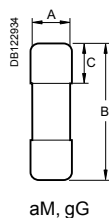
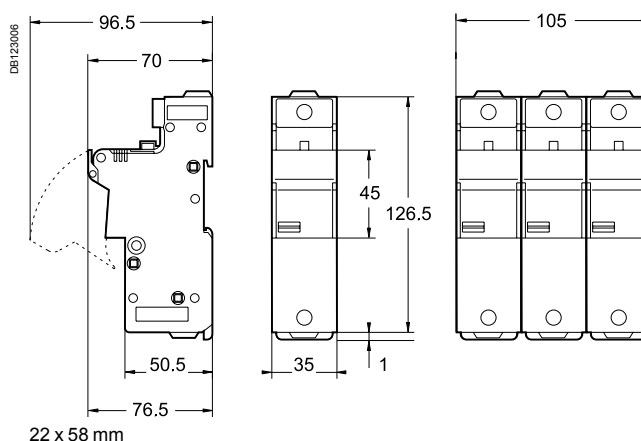
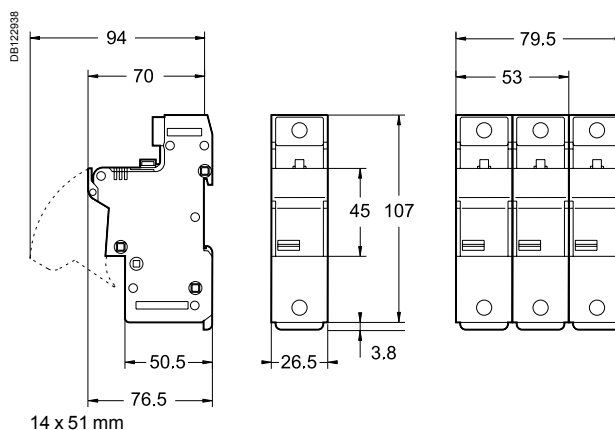

### aM, gG fuse cartridge

Type	A	B	C
14 x 51 mm	14.3	51	13.8
22 x 58 mm	22.2	58	16.2



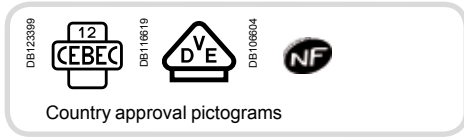

EN 61095, IEC 1095

**iCT contactors are available in two versions:**

- Contactors without manually-operated
- Contactors with manually-operated.

The breadth of the iCT contactor range satisfies most application cases.



Manual control

- iCT contactors can be used to remote control applications in alternative networks:
  - lighting, heating, ventilation, roller blinds, sanitary hot water
  - mechanical ventilation systems, etc
  - load-shedding of non-priority circuits

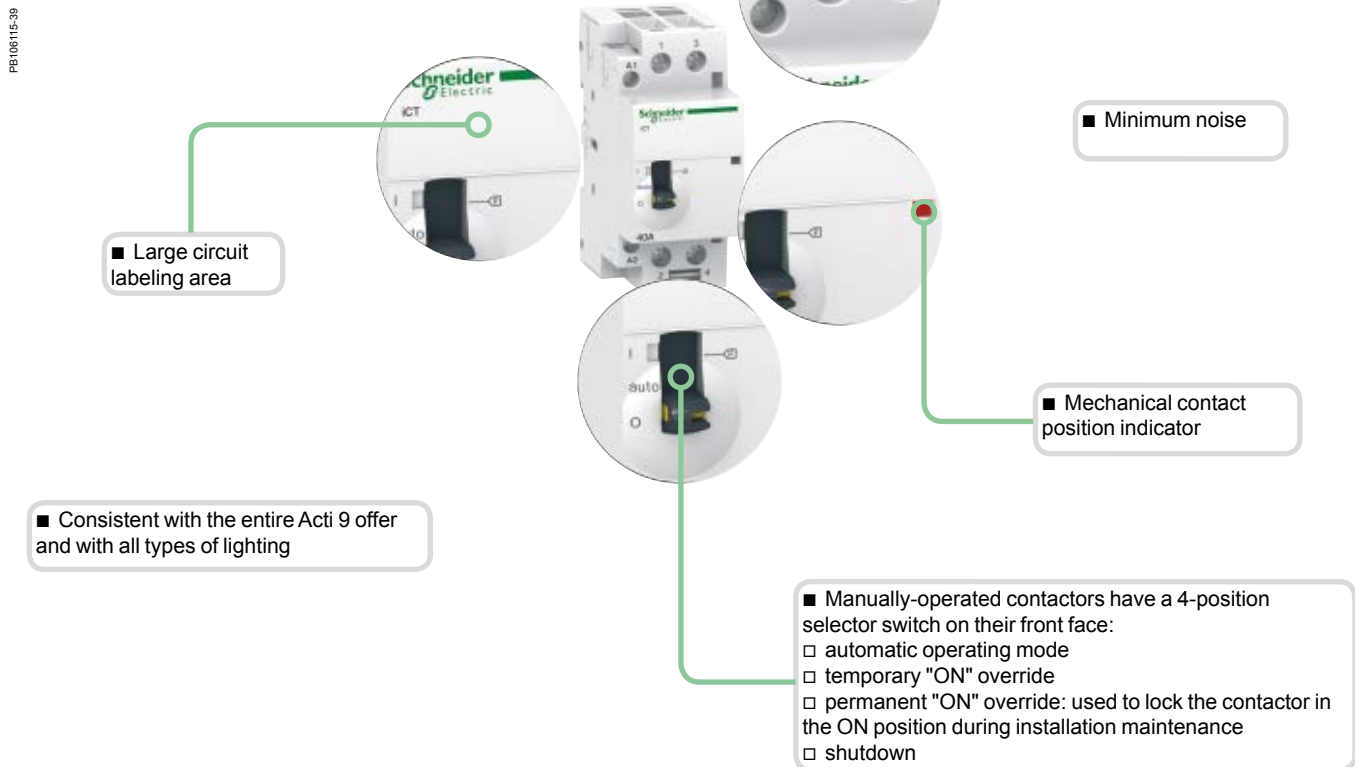

## Catalogue numbers

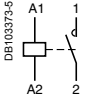
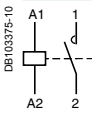
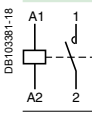
iCT contactors - 50 Hz						
Type	Rating (In)		Control voltage (V AC) (50 Hz)	Contact		Width in 9 mm modules
	AC7a	AC7b				
<b>1P</b> 	25 A	8.5 A	230...240	1NO	<b>A9C20731</b>	2
<b>2P</b> 	16 A 25 A 40 A	6 A 8.5 A 15 A	230...240 230...240 220...240	2NO 2NO 2NO	<b>A9C22712</b> <b>A9C20732</b> <b>A9C20842</b>	2 2 4
<b>4P</b> 	25 A	8.5 A	220...240	4NO	<b>A9C20834</b>	4

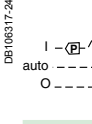
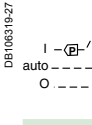
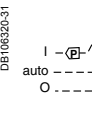
iCT manual control contactor 50 Hz						
Type	Rating (In)		Control voltage (V AC) (50/60 Hz)	Contact		Width in 9 mm modules
	AC7a	AC7b				
<b>2P</b> 	25 A	8.5 A	230...240	2NO	<b>A9C21732</b>	2
<b>3P</b> 	25 A	8.5 A	220...240	3NO	<b>A9C21833</b>	4
<b>4P</b> 	25 A	8.5 A	220...240	4NO	<b>A9C21834</b>	4

## Operation (Manual control contactor)

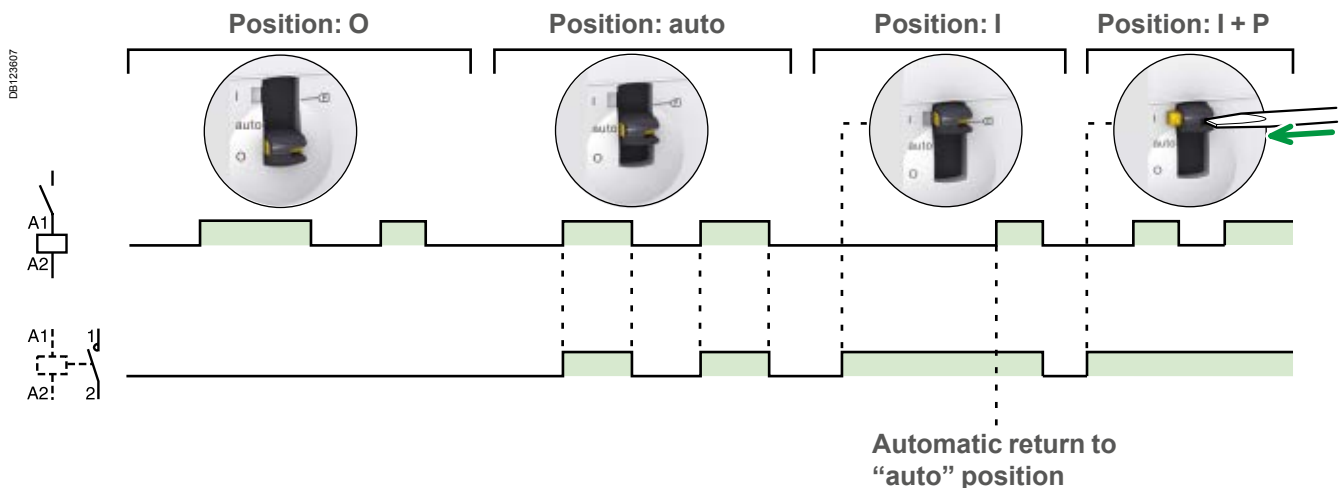

## Connection

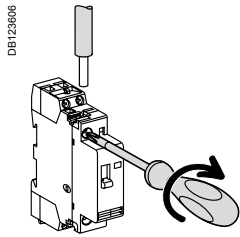

Type	Rating	Length tripping	Circuit	Tightening torque	Copper cables		
					Rigid	Flexible or with ferrule	
iCT	PZ1: 4 mm	16 - 40 A	9 mm	Control	0.8 N.m	1.5 to 2.5 mm, 2 x 1.5 mm <sup>2</sup>	1.5 to 2.5 mm, 2 x 2.5 mm <sup>2</sup>
		16 and 25 A	9 mm	Power			
	PZ2: 6 mm	40 A	14 mm		3.5 N.m	6 to 25 mm <sup>2</sup>	6 to 16 mm <sup>2</sup>

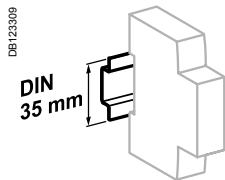

Clip on DIN rail 35 mm.

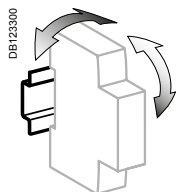

± 30° vertical.

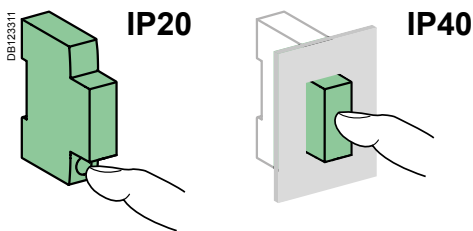

## Technical data

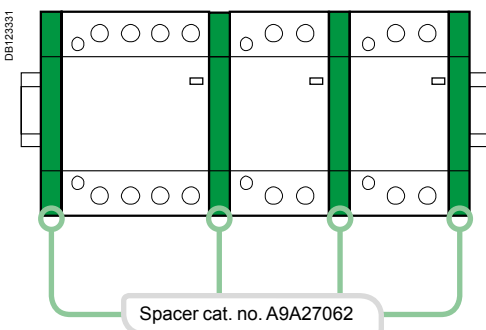

Power circuit		
Voltage rating (Ue)	1P, 2P	250 VAC
	3P, 4P	400 VAC
Frequency	50 Hz or 60 Hz	
Endurance (O-C)		
Electrical	100,000 cycles	
Maximum number of switching operation a day	100	
Additional characteristics		
Insulation voltage (Ui)	500 VAC	
Pollution degree	2	
Rated impulse withstand voltage (Uimp)	2.5 kV (4 kV for 12/24/48 VAC)	
Degree of protection (IEC 60529)	Device only	IP20
	Device in modular enclosure	IP40
Operating temperature	-5°C to +60°C <sup>(1)</sup>	
Storage temperature	-40°C to +70°C	
Tropicalization (IEC 60068-1)	Treatment 2 (relative humidity 95 % at 55°C)	
The product control conforms to the SELV (safety extra low voltage) requirements		

(1) In the case of contactor mounting in a enclosure for which the interior temperature is in range between 50°C and 60°C, it is necessary to use a spacer, cat. no. A9A27062, between each contactor



## Mounting accessories

Sealable screw shields for top and bottom	3P, 4P 25 A	<b>A9A15921</b>
	2P 40 A	<b>A9A15922</b>
9 mm spacer	<b>A9A27062</b>	
Clip-on terminal markers	<b>See page 97</b>	

Security			
Accessories	Sealable screw shields		Spacer
 PB104485-15	 PB104486-15	 PB104483-40	
<b>Function</b>			
<ul style="list-style-type: none"> <li>■ Designed to cover terminals to avoid contact with device screws.</li> <li>■ Allow sealing</li> </ul>		<ul style="list-style-type: none"> <li>■ Required to reduce temperature rise of modular devices installed side by side.</li> <li>■ Recommended to separate electronic devices (thermostat, programmable clock, etc.) from electromechanical devices (relays, contactors).</li> </ul>	
<ul style="list-style-type: none"> <li>■ For iCT: 3P, 4P - 25 A</li> </ul>		<ul style="list-style-type: none"> <li>■ For iCT: 2P - 40 A</li> </ul>	
<b>Use</b>			
<ul style="list-style-type: none"> <li>■ Bag of 10 upstream/10 downstream</li> </ul>		<ul style="list-style-type: none"> <li>■ Bag of 5</li> </ul>	
<b>Catalogue numbers</b>	<b>A9A15921</b>	<b>A9A15922</b>	<b>A9A27062</b>
<b>Technical specifications</b>			
Width in 9 mm modules	4	4	1
Number of poles	3P, 4P	2P	–

## Consumption

### iCT contactors - 50 Hz

#### Type

1P	Rating (In)		Control voltage (V AC) (50 Hz)	Consumption		Max. power	
	AC7a	AC7b		Holding	Inrush		
	25 A	8.5 A	230...240	2.7 VA	9.2 VA	1.2 W	<b>A9C20731</b>
2P	16 A	5 A	230...240	2.7 VA	9.2 VA	1.2 W	<b>A9C22712</b>
	25 A	8.5 A	230...240	3.8 VA	15 VA	1.3 W	<b>A9C20732</b>
	40 A	15 A	220...240	4.6 VA	34 VA	1.6 W	<b>A9C20842</b>
4P	25 A	8.5 A	220...240	4.6 VA	34 VA	1.6 W	<b>A9C20834</b>

### iCT manual control contactor 50 Hz

#### Type

2P	Rating (In)		Control voltage (V AC) (50 Hz)	Consumption		Max. power	
	AC7a	AC7b		Holding	Inrush		
	25 A	8.5 A	220	2.7 VA	9.2 VA	1.2 W	<b>A9C21732</b>
3P	25 A	8.5 A	220...240	4.6 VA	34 VA	1.6 W	<b>A9C21833</b>
4P	25 A	8.5 A	220...240	4.6 VA	34 VA	1.6 W	<b>A9C21834</b>

## Dimensions (mm)

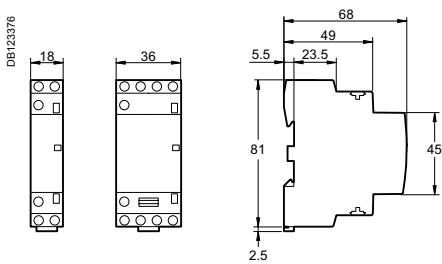

iCT 16/25 A

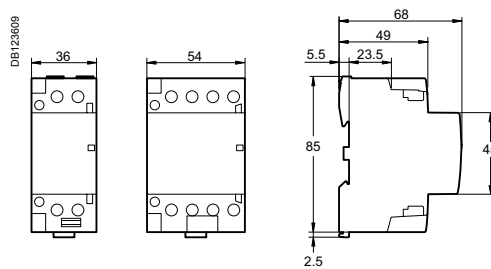

iCT 40 A

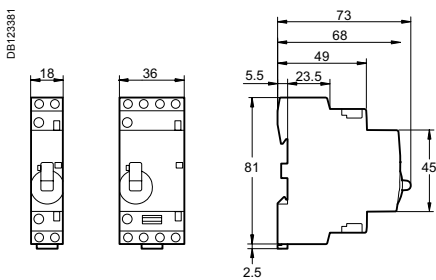

iCT manual control contactor 25 A

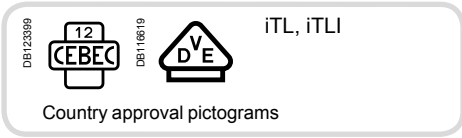

IEC/EN 60669-2-2



### Impulse relays are used:

- Closing of the impulse relay pole(s) is triggered by an impulse on the coil.
- Having two stable mechanical positions, the pole(s) will be opened by the next impulse. Each impulse received by the coil reverses the position of the pole(s).
- Can be controlled by an unlimited number of pushbuttons.
- Zero energy consumption.

- Large circuit labeling area
- Consistent with the entire Acti 9 offer and with all types of lighting
- Manual controls on front face: direct and priority manual control by O-I toggle
- Mechanical contact position indicator
- Insulated terminals IP20
- Disconnection of remote control by selector switch for maintenance operation
- Built-in or optional auxiliary function: state indication, centralised control, latched control, control for illuminated pushbutton, step-by-step control, time delay

## Catalogue numbers

iTL impulse relays				
Type	1P		2P	
	<p>1 NO</p>		<p>2 NO</p>	
<b>Rating (In)</b>	<b>Control voltage (Uc)</b>			
	<b>(V AC) (50/60 Hz)</b>	<b>(V DC)</b>		
<b>16 A</b>	230...240	110	<b>A9C30811</b>	<b>A9C30812</b>
Width in 9 mm modules			2	2

## Operation

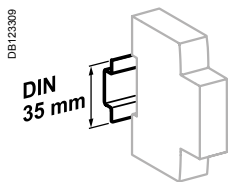
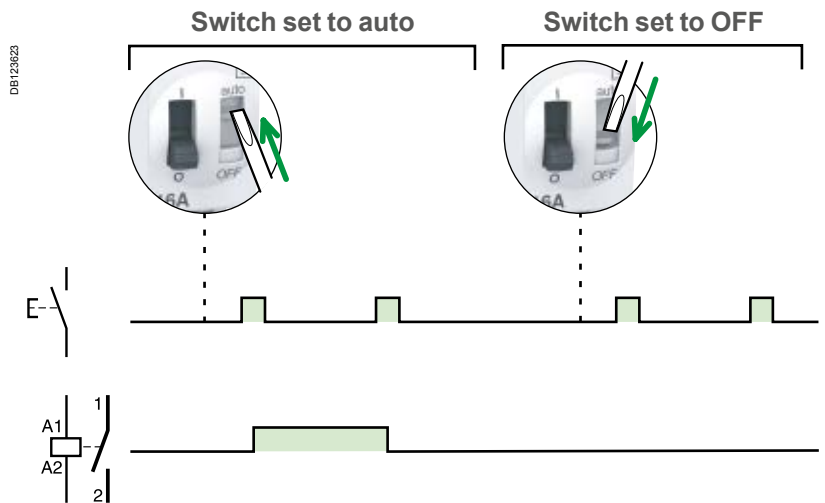

Clip on DIN rail 35 mm.

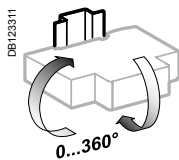

Indifferent position of installation.

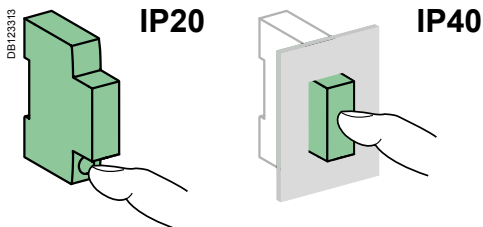

## Technical data



Control circuit		iTL
Control voltage (Uc)	Tolerance at 50 Hz	+6 %, -15 %
	Tolerance at 60 Hz	±6 %
	Tolerance V DC	+6 %, -10 %
Dissipated power (during the impulse)		1, 2, 3P: 19 VA 4P: 38 VA
Illuminated PB control		Max. current 3 mA
Operating threshold		Min. 85 % of Un in conformance with IEC/EN60669-2-2
Duration of the control order		50 ms to 1 s (200 ms recommended)
Response time		50 ms
Power circuit		
Voltage rating (Ue)	1P, 2P	24 ...250 V AC
Frequency		50 Hz or 60 Hz
Maximum number of operations per minute		5
Maximum number of switching operation a day		100
Additional characteristics		
Insulation voltage (Ui)		440 V AC
Pollution degree		3
Rated impulse withstand voltage (Uimp)		6 kV
Oversvoltage category		IV
Endurance (O-C)		
Electrical		200,000 cycles (AC21)
		100,000 cycles (AC22)
Other characteristics		
Degree of protection (IEC 60529)	Device only	IP20
	Device in modular enclosure	IP40 Insulation class II
Operating temperature		-20°C to +50°C
Storage temperature		-40°C to +70°C
Tropicalization (IEC 60068-1)		Treatment 2 (relative humidity 95 % at 55°C)

## Mounting accessories

9 mm spacer	<b>A9A27062</b>
Clip-on terminal markers	<b>See page 97</b>

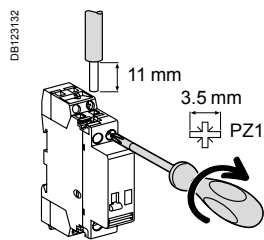
## Connection



Type	Rating	Circuit	Tightening torque	Copper cables	
				Rigid or with ferrule	Flexible or with ferrule
iTL	16 A	Control	1 N.m		
		Power		0.5 to 4 mm <sup>2</sup>	1 to 4 mm <sup>2</sup>
				0.5 to 4 mm <sup>2</sup>	1.5 to 4 mm <sup>2</sup>

## Dimensions (mm)

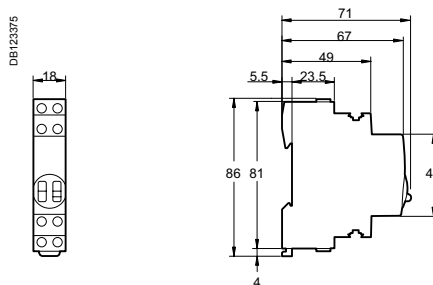

iTL

## Security

### Accessories

### Spacer



### Function

- Required to reduce temperature rise of modular devices installed side by side.
- Recommended to separate electronic devices (thermostat, programmable clock, etc.) from electromechanical devices (relays, contactors).

### Catalogue numbers

**A9A27062**

### Technical specifications

Width in 9 mm modules

1



Time delay relay is used in service sector and industrial buildings for small automatic control systems: ventilation, heating, animation, roller blind servo controls, escalators, pumps, lighting, signalling, monitoring, etc.

## > Time delay relays



**iRTA**  
■ Delays energizing of a load

## ^ Time delay

iRLI relay is used to relay ON or OFF information to the auxiliary circuits and actuate low-power loads

## > Changeover relays



**iRLI**  
**Changeover**  
■ Relays ON or OFF information to the auxiliary circuits  
■ Actuates low-power loads

## ^ Relaying and control

Control relays monitor electrical parameters and indicate when they are exceeded

## > Control relays



**iRCP**  
**Phase control**  
■ Monitors the order and asymmetry of phases and the presence of voltage on the 3 phases of a three-phase circuit (power supply of a motor, etc.)

## ^ Monitoring

## Time delay relays

### iRTA

#### Type

PB111581-35



#### Function

- Delays energizing of a load

#### Wiring diagrams

DB123675

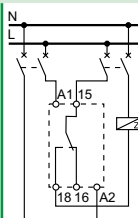

#### Use

DB123681

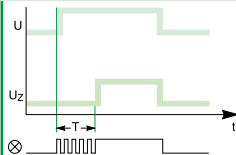

- The single time delay cycle starts at switching on of the iRTA relay power supply
- The load is energized at the end of time delay T

#### Catalogue numbers

**A9E16065**

#### Technical specifications

Control and power supply voltage (Uc)	V AC	24...240, ±10 %
	V DC	24, ±10 %
Operating frequency	Hz	50/60
Time delay range		0.1 s to 100 h
Precision		±10 % of full scale
Minimum duration of control impulse		100 ms
Insensitive to brownouts		≤ 20 ms
Max. resetting time per voltage interruption		100 ms
Accuracy of repetition		±0.5 % at constant parameters
Changeover contact (cadmium free)	Mini	Rating 10 mA/5 V DC
	Maxi	Rating 8 A/250 V AC/DC
Endurance	Mechanical	> 5 x 10 <sup>6</sup> switching operations
	Electrical	> 10 <sup>5</sup> switching operations (utilization category AC1)
Display of contact status by green indicator lamp		Flashing during time delay
Degree of protection	Device only	IP20
Connection by tunnel terminals	Without ferrule	2 x 2.5 mm <sup>2</sup> single-strand
	With ferrule	2 x 1.5 mm <sup>2</sup> multi-strand
Width in 9-mm modules		2
Operating temperature	°C	-5 ... +55
Storage temperature	°C	-40 ... +70

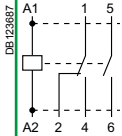
Changeover and extension relays		
<b>iRLI</b>		
<b>Type</b>	Changeover relay	
		
Standard	IEC/EN 61810-1 and NF C 45-250	
<b>Function</b>	<ul style="list-style-type: none"> <li>Relaying of ON or OFF information to the auxiliary circuits and actuation of low-power loads</li> </ul>	
<b>Wiring diagrams</b>		
<b>Use</b>	<ul style="list-style-type: none"> <li>The iRLI relay contains 1 changeover contact (O-C) and 1 normally open contact (N/O)</li> </ul>	
<b>Catalogue numbers</b>	<b>A9E15535</b>	
<b>Technical specifications</b>		
Control voltage (Uc)	V AC	230...240
Voltage rating (Ue)	V AC	230
Insulation voltage (Ui)	V AC	250
Rating (In)	A	10, cos φ = 1
Operating frequency	Hz	50/60
Inrush and holding power		4 VA
Endurance	Electrical	100,000 cycles AC21 (cos φ = 1)
Direct front face control	Power	By push button
	Coil	By selector switch (disconnection)
Position indicator		Mechanical indicator
Marking		Clip-on markers on the front panel
Degree of protection	Device only	IP20
Connection by tunnel terminals		0.5 x 6 mm <sup>2</sup>
Width in 9-mm modules		2
Operating temperature	°C	-5 ... +55
Storage temperature	°C	-40 ... +70

# iRCP phase control relay

## Control relays

<b>iRCP</b>	
<b>Type</b>	<b>Phase control</b>
<b>Function</b>	<p>■ Monitors phases and the presence of voltage on the 3 phases of a three-phase circuit (power supply of a motor, etc.). It indicates any phase loss or inversion</p>
<b>Wiring diagrams</b>	
<b>Catalogue number</b>	<b>A9E21180</b>
<b>Common technical specifications</b>	
Supply voltage (Uc)	V AC 400, ±15 %
Frequency	Hz 50/60
Parameter setting	■ On the front panel, by direct scale, using a screwdriver
Precision of display	±10 % of full scale
Output by changeover contact	8 A under 250 V AC (cos φ = 1)
Indications by LED	Green Voltage presence
	Red Fault
Consumption	VA 3
Dissipated power	W 3 (total on the 3 phases)
Degree of protection	Device only IP20
Connection by tunnel terminals	Rigid cable 1.5 x 6 mm <sup>2</sup>
Width in 9-mm modules	4
Operating temperature	°C -5 ... +55
Storage temperature	°C -40 ... +80
<b>Particular technical specifications</b>	
	Setting of phase asymmetry threshold: 5 % to 25 % of 400 V
	Hysteresis: fixed, 5 % of asymmetry threshold
	Monitoring of direction of phase rotation
	Monitoring of presence of the 3 phases
	Fail-safe contact
	De-energized
	Energized with fault
	Energized without fault
	Time delay on tripping: 0.3 s

## Technical data

### Weight (g)

Relays	
Type	
iRTA	65
iRLI	112
iRCP	210

### Dimensions (mm)

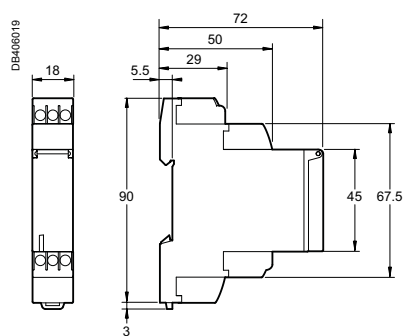

iRTA

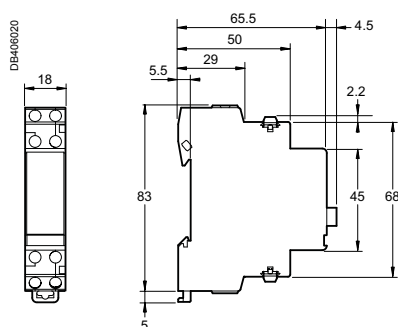

iRLI

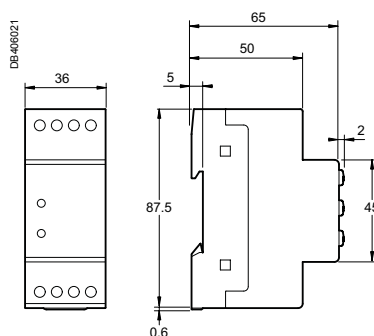

iRCP

## IEC 60947-5-1



- iLL indicator, light up to indicate that a voltage is present.

## Catalogue numbers

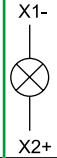
### iLL indicator light

	
Diagram	
Colour	Red
<b>Cat. no.</b>	<b>A9E18320</b>
110...230 V AC	
110...130 V DC	
Width in 9 mm modules	2

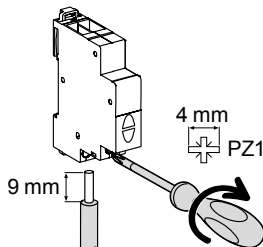
## Connection

	<b>Tightening torque</b>	<b>Copper cables</b>	
		<b>Rigid</b>	<b>Flexible or with ferrule</b>
	1 N.m		
		0.5 mm <sup>2</sup> min. 2 x 2.5 mm <sup>2</sup> max.	0.5 mm <sup>2</sup> min. 2 x 2.5 mm <sup>2</sup> max.

- Phase-separated wall that can be divided to allow the teeth of all types of comb busbar to pass through.
- Staggered terminals to simplify connection.

## Dimensions (mm)

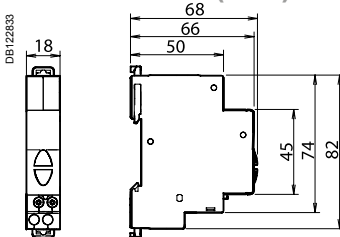

## Technical data

<b>Main characteristics</b>	
Pollution degree	3
<b>Power circuit</b>	
Operating frequency	50...60 Hz
Flashing frequency	2 Hz
<b>Additional characteristics</b>	
Operating temperature	-35°C... +70°C
Storage temperature	-40°C... +80°C
Tropicalization	Treatment 2 (relative humidity 95 % at 55°C)
LED indicator light	Consumption per indicator light: 0.3 W
	Service life: 100,000 hours of constant lighting efficiency
	Maintenance-free indicator light (non-interchangeable LEDs)



iSO

## iSO

Audible indication in housing and the tertiary sector.

## Catalogue number

Bell and buzzer			
Type	Voltage (Ue)		Width in 9 mm modules
iSO bell	230 V AC	A9A15320	2
Operating frequency		50...60 Hz	



## Connection

Tightening torque	Copper cables	
	Rigid	Flexible or with ferrule
1.3 N.m	< 4 mm <sup>2</sup>	< 4 mm <sup>2</sup>

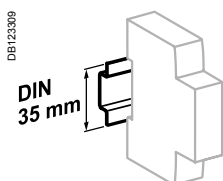
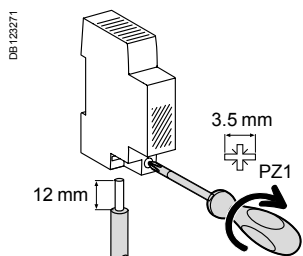

Clip on DIN rail 35 mm.

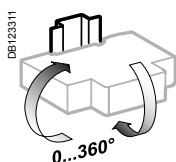

Indifferent position of installation.

## Technical data

Main characteristics		iSO
Consumption	220...240 V AC	5 VA
Additional characteristics		
Degree of protection (IEC 60529)	Device only	IP40
	Device in modular enclosure	IP20
Operating temperature	-10°C to +40°C	
Storage temperature	-25°C to +60°C	
Sound level (at a distance of 60 cm)	80 dBA	

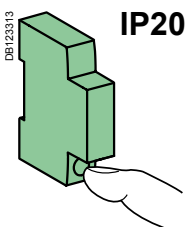

IP20

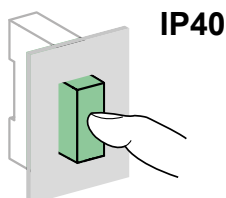

IP40

## Weight (g)

Bell and buzzer	
Type	Weight (g)
iSO	77

## Dimensions (mm)

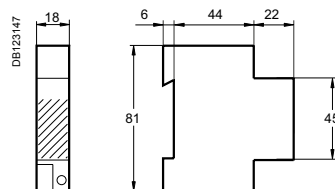

iSO bell

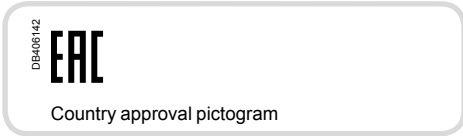

### Bell transformers: EN/IEC 61558-2-8.

### Safety transformers: EN/IEC 61558-2-6.

Bell transformers and safety transformers allow for a very low voltage (ELV 8 V, 12 V or 24 V) to be obtained from a low voltage network (LV 230 V).

All Schneider Electric transformers are:

- Safe: primary and secondary circuits are perfectly insulated by each other
- Resistant to short-circuit currents thanks to the built-in device
- Class II with terminal shield (optional).

## Catalogue numbers

Bell transformer				
Type	Power	Secondary voltage		Width in 9 mm modules
ESB760 	8 VA	8-12 V AC	<b>A9A15216</b>	4
ESB761 	25 VA	12-24 V AC	<b>A9A15215</b>	6

Safety transformer				
Type	Power	Secondary voltage		Width in 9 mm modules
DBE12A154 	63 VA	12-24 V AC	<b>A9A15222</b>	10
Operating frequency	50/60 Hz			

Terminal shield		
Type		Width in 9 mm modules
	<b>15228</b>	4
	<b>15229</b>	6



## Connection

Tightening torque	Copper cables	
	Rigid	Flexible or with ferrule
0.5 N.m	< 2.5 mm <sup>2</sup>	< 2.5 mm <sup>2</sup>

## Technical data

### Main characteristics

Primary voltage	230 V AC ±10 %
Secondary voltage on load	For bell transformers: 8-12-24 V AC ±15 % For safety transformers: 12-24 V AC ±5 %

Transformer catalogue numbers	Rated secondary voltage	Off load voltage
A9A15216	8 V	13 V
	12 V	18 V
A9A15215	12 V	16 V
	24 V	32 V
A9A15222	12 V	14 V
	24 V	28 V

### Additional characteristics

Degree of protection (IEC 60529)	Device only	IP20 with terminal shield
Operating temperature	-20°C to +55°C	
Storage temperature	-25°C to +80°C	

Note: Transformers have an off load operating voltage that is higher than the rated voltage. For loads that are sensitive to overloads (electro-magnetic circuits), the transformer must be made to operate at In. After operation of the protection device upon an overload, cut-off the power supply and let the transformer cool down before restart.

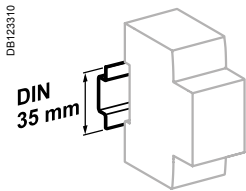

Clip on DIN rail 35 mm.

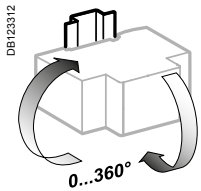

Bell transformer: indifferent position of installation.  
Safety transformer: vertical position.

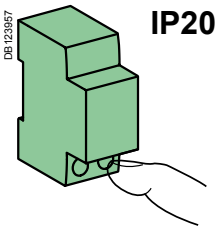

## Weight (g)

iTR		
Type	Cat. no.	Weight
Bell	A9A15215	633
	A9A15216	275
Safety	A9A15222	1309

## Dimensions (mm)

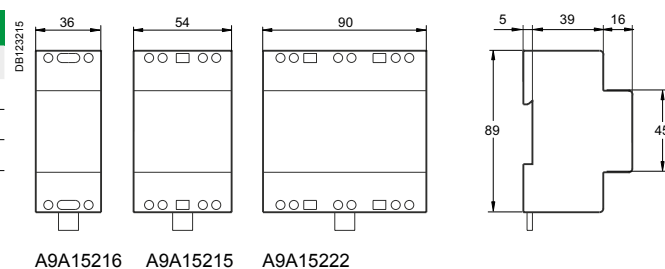

These power sockets allow low-voltage devices to be connected to the electrical network.

IEC 60884

## Catalogue numbers

### iPC 16 A power sockets

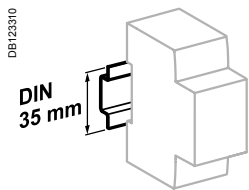

Clip on DIN rail 35 mm.

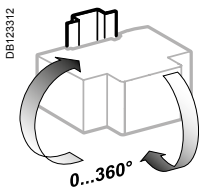

Indifferent position of installation.

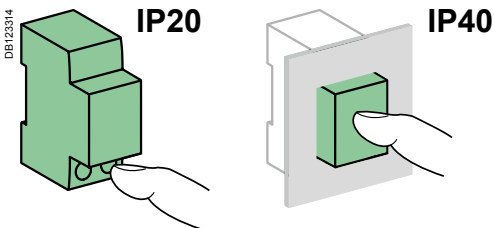

## Dimensions (mm)

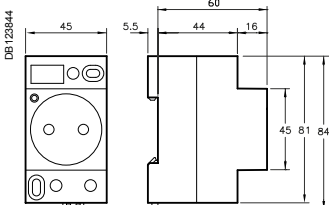

iPC 16 A NF standard

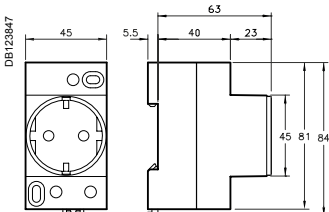

iPC 16 A VDE standard

Diagram		
Approval pictogram		
<b>Type</b>	<b>Standard</b>	<b>Standard</b>
Color	White	White
Cover	With	Without
<b>Cat. no.</b>	<b>A9A15306</b>	<b>A9A15310</b>
Standard	NF C 61314, NBN C 61112 NF C 15100 with "baby safe" type cover	VDE 0620, NEN 1020
Width in 9-mm modules	5	

## Connection

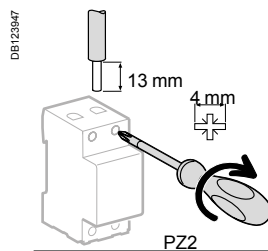

Type	Tightening torque	Copper cables	
		Rigid	Flexible or with ferrule
iPC 16 A	1.2 N.m	10 mm <sup>2</sup>	6 mm <sup>2</sup>

## Technical data

<b>Main characteristics</b>		<b>iPC 16 A</b>
Voltage rating (Ue)		250 V AC
<b>Additional characteristics</b>		
Degree of protection (IEC 60529)	Device only	IP20
	Device in modular enclosure	IP40
Operating temperature		-25°C to +70°C
Storage temperature		-40°C to +80°C
Tropicalization (IEC 60068-1)		Treatment 2 (relative humidity of 95 % at 55°C)

## Weight (g)

iPC power sockets	
Type	
iPC 16 A	98

## IEC 60669-1 and IEC 60947-5-1



- iPB pushbutton are used to control electric circuits by means of pulses.

## Catalogue numbers

### iPB pushbuttons

		PBI00259-40	
Diagram		1 NO 1 E— 2	
Pushbutton	Colour	Grey	
Cat. no.		A9E18032	
Width in 9 mm modules		2	

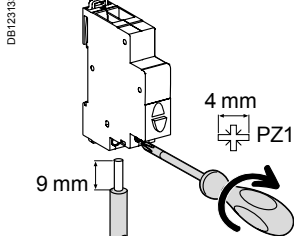
## Connection

	Tightening torque	Copper cables	
	1 N.m	Rigid	Flexible or with ferrule
		DBI22345 	DBI22346 
		0.5 mm <sup>2</sup> min. 2 x 2.5 mm <sup>2</sup> max.	0.5 mm <sup>2</sup> min. 2 x 2.5 mm <sup>2</sup> max.

- Phase-separated wall that can be divided to allow the teeth of all types of comb busbar to pass through.
- Staggered terminals to simplify connection.

## Dimensions (mm)

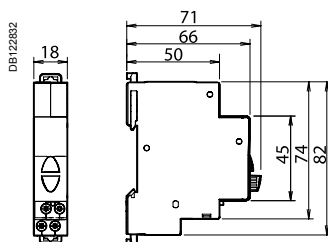

## Technical data

Main characteristics	
Pollution degree	3
Power circuit	
Voltage rating (Ue)	250 V AC
Current rating (Ie)	20 A
Additional characteristics	
Endurance (O-C)	30,000 operations AC22 (cos φ = 0.8)
Operating temperature	-35°C... +70°C
Storage temperature	-40°C... +80°C
Tropicalization	Treatment 2 (relative humidity 95 % at 55°C)

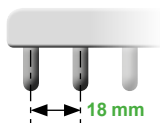

IEC 60947-7-1, IEC 61439-2



Acti 9 iC60	18 mm poles, cuttable			
Number of poles	1P	1P+N	3P	3P+N
Type	L1	N L	L1 L2 L3	N L1 L2 L3
Set of	L1...	NL...	L1L2L3...	NL1L2L3...
Set of	1	1	1	1
<b>Catalogue numbers</b>				
6 modules of 18 mm	A9XPH106	-	A9XPH306	-
12 modules of 18 mm	A9XPH112	A9XPH212	A9XPH312	A9XPH412
24 modules of 18 mm	A9XPH124	A9XPH224	A9XPH324	A9XPH424
57 modules of 18 mm	A9XPH157	A9XPH257	A9XPH357	A9XPH457

Technical data	
Operating current (Ie) at 40°C	100 A
Short circuit current (Isc)	Compatible with the breaking capacity of Schneider Electric circuit breakers
Rated insulation voltage (Ui)	500 V AC
Operating voltage (Ue)	415 V AC
Pollution degree	3
Fire resistance IEC 695-2-1	Self-extinguishing at 960°C 30 secondes
Color	RAL 7016 (anthracite grey)

**End-pieces**  
■ essential to ensure the correctly comb busbars insulation



**Connectors**  
■ facilitate comb busbar power supply

Accessories	1P	1P+N	3P	3P+N	-	-
Number of poles						
	<b>End-pieces</b>				<b>Tooth covers</b>	<b>Connectors</b>
	Lateral end-pieces providing IP20 protection				Insulate teeth that have been left free	<b>Monoconnect</b> Comb busbar power supply. Horizontal in comer on each side. For 35 mm <sup>2</sup> cable. Tightening torque 4 N.m
Set of	10	10	10	10	20	4
<b>Catalogue numbers</b>	A9XPE110	A9XPE210	A9XPE310	A9XPE410	A9XPT920	A9XPCM04

# Horizontal comb busbars (cont.)

9 mm modules for iDPN N Vigi,  
DPN N Vigi

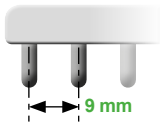

IEC 60439-1



iDPN N Vigi, DPN N Vigi		9 mm poles, cuttable							
Number of poles		1P+N				3 (N+P)			
		 N L				 N L1 N L2 N L3			
Number of 18 mm modules		12	18	24	48	12	18	24	48
Supplied accessories	Tooth covers (for 3 modules of 18 mm)	1	1	2	-	1	1	2	-
	End-pieces	4	4	4	-	4	4	4	-
<b>Catalogue numbers</b>		<b>21501</b>	<b>19512</b>	<b>21503</b>	<b>21089</b>	<b>21505</b>	<b>19516</b>	<b>21507</b>	<b>21093</b>

Technical data		
Operating current at 40°C	(Ie)	80 A
Short circuit current	(Isc)	Compatible with the breaking capacity of Schneider Electric circuit breakers
Rated insulation voltage	(Ui)	440 V AC
Operating voltage	(Ue)	230 V AC (P + N) - 400 V AC (3P + N)
Degree of protection		IP20
Pollution degree		3
Fire resistance IEC 695-2-1		Self-extinguishing at 960°C 30 secondes
Color		RAL 7035

### Connectors

- facilitate comb busbar power supply

### End-pieces

- essential to ensure the correctly comb busbars insulation



### Tooth covers

- Insulate teeth that have been left free

Accessories				
Number of poles	1P+N	3 (N+P)		
	<b>End-pieces</b>		<b>Tooth covers (3 x 18 mm modules)</b>	<b>Tooth covers (1 x 18 mm module)</b>
Set of	40		12	10
<b>Catalogue numbers</b>	<b>21094</b>	<b>21095</b>	<b>21096</b>	<b>10405</b>
				<b>Connectors (grey)</b>
				4
				<b>21098</b>

PB11254-30\_1.eps



PB11246-20\_1.eps



### IEC/EN 60947-7-1, IEC/EN 61439-1 & 2



#### Description

- Four-pole distribution block that can be installed on a standard DIN rail or on a mounting plate.
- Compatible with Prisma G and P, Pragma, Mini Pragma and Resbo series switchboards.
- Incomers and feeders are connected to screw terminals that accept rigid or flexible cables with ferrule.
- Optional: additional neutral terminal strip for four-pole distribution block.

#### Advantages

- Simplified power supply for main incomers.
- Easy phase balancing.
- Easy, effortless cabling due to excellent accessibility.
- Visible cabling.
- Insulation between phases.
- The single-pole distribution blocks are adjacent and bridgeable via the second incoming hole for parallel connection.

#### Screw distribution blocks

Number of poles	4P	
		
Rated operational current	100 A	160 A
Total connections capacity	4 x 7	4 x 12
<b>Terminal capacity</b>		
Diameter	2 x Ø 7.5 mm	1 x Ø 12 mm
	5 x Ø 5.5 mm	3 x Ø 9 mm
	-	8 x Ø 7.5 mm
	-	-
Rated peak withstand current (I <sub>pk</sub> )	I <sub>pk</sub> /60 ms: 14 kA	22 kA
	I <sub>pk</sub> /6 ms: 24 kA	36 kA
Rated short-time withstand current (I <sub>cw</sub> ) (IEC/EN 60947-7-1)	3 kA rms/1 s	8.4 kA rms/1 s
Width (number of 9 mm pitches)	8	18
Dimension (H x W x D)	100 x 71 x 50.5	100 x 174 x 50.5
Weight (g)	210	567
<b>References</b>	<b>LGY410028</b>	<b>LGY416048</b>

DB400005\_1eps



On LGY416048 references.  
Input cabling facilitated by side terminals.

### Technical data

#### Common characteristics

To IEC/EN 60947-7-1 and IEC/EN 61439-1 & 2

Rated insulation voltage (Ui)	500 V AC
Rated operational voltage (Ue)	230 V AC (Ph/N) 440 V AC (Ph/Ph)
Rated impulse withstand voltage (Uimp)	8 kV
Rated conditional short-circuit current of an assembly	Up to the breaking capacity of Schneider Electric feeder circuit breakers, even in cascading configuration
Network frequency	50/60 Hz
Pollution degree	3
Overvoltage category	III

#### Additional technical characteristics

Reference temperature	40 °C
Operating temperature	-25 °C to 55 °C
Dielectric withstand (IEC/EN 60947-1)	2500 V AC

### Terminal technical data

Type	PZ2 screw							
Diameter	Ø 5.5 mm	Ø 5.8 mm	Ø 6 mm	Ø 6.5 mm	Ø 7.5 mm	Ø 8.5 mm	Ø 9 mm	Ø 9.5 mm
Section rigid cable	1.5 to 16 mm <sup>2</sup>	1.5 to 16 mm <sup>2</sup>	1.5 to 16 mm <sup>2</sup>	1.5 to 16 mm <sup>2</sup>	2.5 to 25 mm <sup>2</sup>	6 to 35 mm <sup>2</sup>	10 to 35 mm <sup>2</sup>	10 to 35 mm <sup>2</sup>
Section flexible cable or with ferrule	1.5 to 10 mm <sup>2</sup>	1.5 to 10 mm <sup>2</sup>	1.5 to 10 mm <sup>2</sup>	1.5 to 10 mm <sup>2</sup>	1.5 to 16 mm <sup>2</sup>	4 to 25 mm <sup>2</sup>	4 to 25 mm <sup>2</sup>	6 to 35 mm <sup>2</sup>
Tightening torque	2 N.m	2 N.m	2 N.m	2 N.m	2 N.m	2 N.m	2.5 N.m	2.5 N.m
Type	Hc screw							
Diameter	Ø 9.5 mm	Ø 10 mm	Ø 12 mm		Ø 15.3 mm			
Section rigid cable	10 to 35 mm <sup>2</sup>	1.5 to 50 mm <sup>2</sup>	25 to 70 mm <sup>2</sup>		35 to 120 mm <sup>2</sup>			
			 $\varnothing \leq 15 \text{ mm}$					
Section flexible cable or with ferrule	6 to 35 mm <sup>2</sup>	1.5 to 35 mm <sup>2</sup>	16 to 50 mm <sup>2</sup>		25 to 95 mm <sup>2</sup>			
Tightening torque	8 N.m	4 N.m	1P: 9 N.m	4P: 5 N.m	14 N.m			

### Dimensions (mm)

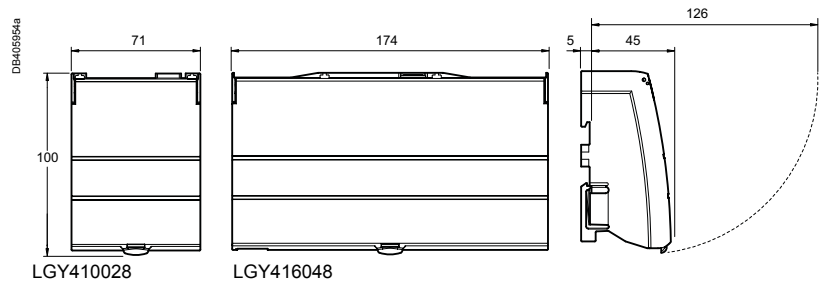





IEC 60947-7-1, IEC 61439-2

**Description**

- Downstream circuits are connected from the front, to spring terminals.
- Contact pressure automatically adapts to the size of the conductor.
- Contacts are insensitive to vibrations and thermal variations.
- Only one cable (flexible or rigid) can be inserted per terminal.

Quick distribution blocks		
Number of poles	4P, incomers from top	4P, incomers from bottom
	 <small>PB104600.6.eps</small>	 <small>PB104499.6.eps</small>
Rated operational current at 40 °C (Ie)	63 A	63 A
Rated conditional short-circuit current of an assembly (Isc)	The reinforced breaking capacity due to cascading in circuit breaker combinations is maintained. The worst-case situations have been tested.	The reinforced breaking capacity due to cascading in circuit breaker combinations is maintained. The worst-case situations have been tested.
Rated insulation voltage (Ui)	500 V AC	500 V AC
Rated operational voltage (Ue)	440 V AC	440 V AC
Rated impulse withstand voltage (Uimp)	6 kV	6 kV
Rated short-time withstand current (Icw)	-	-
Rated operational frequency	50/60 Hz	50/60 Hz
Degree of protection	IPxxB	IPxxB
Incoming terminals	1 tunnel terminal 25 <sup>2</sup> /phase	1 tunnel terminal 25 <sup>2</sup> /phase
Total connection capacity, outgoing terminals	24 connections: 4 x 6 <sup>2</sup> /phase 12 x 6 <sup>2</sup> /neutral	24 connections: 4 x 6 <sup>2</sup> /phase 12 x 6 <sup>2</sup> /neutral
Dimensions (H x W x D)	96.5 x 72 x 62 8 x 9 mm pitch	96.5 x 72 x 62 8 x 9 mm pitch
Installation	Clipped onto a DIN rail	Clipped onto a DIN rail
Other		
Standard for installation inside Prisma	IEC 61439-2	IEC 61439-2
Glow-wire 60695-2-11	960 °C	960 °C
Degree of pollution	3	3
<b>References</b>	<b>04040</b>	<b>04041</b>

**Advantages**

- A reliable electrical connection, no maintenance required (tightness guaranteed over time).
- Quick connection.
- Easy phase balancing.
- Ease of rewiring if the switchboard is expanded or modified.



IEC 60947-7-1, IEC 61439-2

PB104505-30.eps

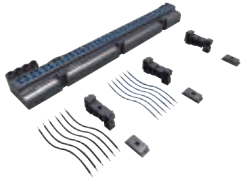

### Description





- Distribution over full rows of modular devices.
- The distribution block is generally supplied by busbars in enclosures and cubicles.
- Easy phase balancing.
- Mix of devices and functions in the same row.
- Installation  $\geq 160$  A: clipped onto the back of a modular rail or screwed onto a solid or pre-slotted plate.

### Distribution blocks

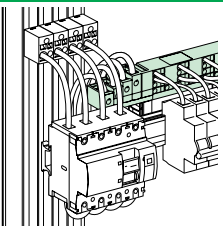
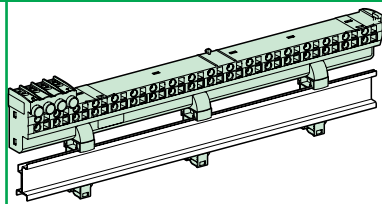
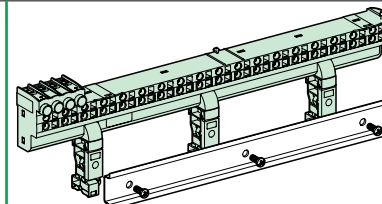



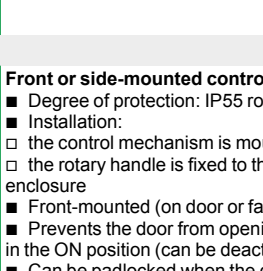

<b>Number of poles</b>		<b>4P</b>	
		PB104501-52-7.eps 	
		<b>80 A</b>	
Rated peak withstand current	(I <sub>pk</sub> )	15 kA	
Rated conditional short-circuit current of an assembly	(I <sub>sc</sub> )	The cascading reinforced breaking capacity when combining circuit breakers is maintained. The worst-case scenarios have been tested. The characteristics are exactly right for the connected devices. Circuit breakers and switches still have their temperature derating curves, and their whole performance is maintained.	
Rated insulation voltage	(U <sub>i</sub> )	500 V AC	
Rated operational voltage	(U <sub>e</sub> )	440 V AC	
Rated impulse withstand voltage	(U <sub>imp</sub> )	6 kV	
Rated operational frequency		50/60 Hz	
Degree of protection		IP20	
Length	In 9 mm modules	48	
	In 18 mm modules	24	
Upstream connection capacity		Tunnel terminals for cables up to 25 mm <sup>2</sup>	
Downstream connection capacity, cable to be used without ferrules	Max. 10 mm <sup>2</sup>	Phasesw	18
		Neutral	18
Accessories included	Pre-stripped copper connections		12 blue + 12 black
<b>References</b>		<b>04000</b>	







### Installation

<p>DD381662-LIN.eps </p> <p>Clipped onto the back of a modular rail, or screw fixing</p>	<p>DB124195-LIN.eps </p> <p>Clipped onto the back of a modular rail, or screw fixing</p>
	<p>DB124196-LIN.eps </p> <p>Can be mounted in Pragma Evolution enclosures and in Prisma Pack 160</p>

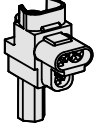
		Mounting						
Accessories	Rotary handle			Plug-in base				
								
								
<b>Function</b>								
	<p><b>Front or side-mounted control</b></p> <ul style="list-style-type: none"> <li>■ Degree of protection: IP55 rotary handle</li> <li>■ Installation: <ul style="list-style-type: none"> <li>□ the control mechanism is mounted on the device</li> <li>□ the rotary handle is fixed to the front or side of the enclosure</li> </ul> </li> <li>■ Front-mounted (on door or faceplate)</li> <li>■ Prevents the door from opening when the device is in the ON position (can be deactivated)</li> <li>■ Can be padlocked when the device is in the "open" position (can be padlocked with the device in the "closed" position subject to adaptation)</li> <li>■ Can be locked by padlock of (dia. 5 to 8 mm), not supplied with the device</li> <li>■ Pushbutton: iID test available in the front face of the rotary handle</li> </ul>			<ul style="list-style-type: none"> <li>■ The Laser Square tool brings the accuracy to align the circuit breaker and the rotary handle</li> </ul>		<p><b>Allows a breaker to be removed or replaced quickly, without handling the connections</b></p> <ul style="list-style-type: none"> <li>■ Degree of protection: IP20</li> <li>■ Consists of: <ul style="list-style-type: none"> <li>□ a base to be fastened on a rail (or panel)</li> <li>□ 2 "blades" to be fastened in the device's terminals</li> </ul> </li> <li>■ Connection: tunnel terminals for cable up to 35 mm<sup>2</sup> rigid, 25 mm<sup>2</sup> flexible,</li> <li>■ Installation: <ul style="list-style-type: none"> <li>□ in universal enclosure</li> <li>□ on horizontal rail</li> </ul> </li> <li>■ Height: 178 mm</li> <li>■ Not compatible with Vigi iC60 and auxiliaries</li> <li>■ Can be locked by padlock of (dia. 6 mm), not supplied with the device</li> </ul>		
<b>Catalogue numbers</b>	<b>A9A27005</b>	<b>A9A27006</b>	<b>A9A27008</b>	<b>GVAPL01</b>	<b>A9A27003 (1 per pole)</b>			
	Operating sub-assembly							
	+	+						
	Black handle	Red handle	No handle					
<b>Set of</b>	<b>1</b>	<b>1</b>	<b>1</b>	<b>1</b>	<b>1</b>			
<b>Suitability</b>								
<b>iC60</b>	■ 2P, 3P, 4P				■			
<b>iSW Acti 9</b>	■ 2P, 3P, 4P				■			
<b>iC60 + Vigi iC60</b>	■ 2P, 3P, 4P				-			
<b>iID</b>	■				■ ≤ 63 A			
<b>iDPN Vigi</b>	-				-			
<b>iSW-NA</b>	■				■			

Padlocking device				Wall mounting	Spare part Locking clips
Front		Side			
PE104492-15  DB123599			A9A26380-40  A9A26381-40	P135159-40  	A9A27052-25  
<b>Used to padlock breaker in open or closed position</b> <ul style="list-style-type: none"> <li>■ Padlock diameter: 3 to 6 mm</li> <li>■ Sealable (max. diameter: 1.2 mm)</li> <li>■ Locking in ON position does not prevent tripping of the breaker in the event of faults</li> <li>■ Suitable for IEC/EN 60947-2 compliant disconnection</li> </ul>		<b>Can be used to padlock a circuit breaker in open position</b> <ul style="list-style-type: none"> <li>■ Attached directly to the circuit breaker, it cannot be lost</li> <li>■ Padlock diameter: 6 mm</li> </ul>		<b>Can be used for wall mounted installation of any 18 mm DIN rail devices</b> <ul style="list-style-type: none"> <li>■ Degree of protection: IP40</li> <li>■ Sealable: (max. diameter: 1.5 mm)</li> </ul>	<b>Top and bottom locking clips for monoconnect iC60</b>
A9A26970		A9A26380 Left-hand mounting	A9A26381 Right-hand mounting	15359	A9A27052
10		1	1	1	10
■	■	■	■	<ul style="list-style-type: none"> <li>■ All products up to 18 mm</li> <li>■ Except iCT</li> </ul>	■
■	–	–	–		–
■	–	–	–		–
■	■	–	–		–
■	–	–	–		–

Security						
Accessories	Screw shield		Terminal shield		Inter-pole barrier	Spacer
						
<b>Function</b>	<b>Prevents any contact with the connecting screws</b> <ul style="list-style-type: none"> <li>Upgrades degree of protection to IP20D</li> <li>Sealable, max. diameter 1.2 mm</li> </ul>		<b>Prevents any contact with the terminals</b> <ul style="list-style-type: none"> <li>Upgrades degree of protection to IP20D</li> <li>Sealable, max. diameter 1.2 mm</li> <li>Set of two, for upstream and downstream terminals</li> <li>For 3 poles: <b>A9A26975 + A9A26976</b></li> <li>For 4 poles: 2 X <b>A9A26976</b></li> </ul>		<b>Enhances insulation between connections: cables, terminals, lugs, etc</b>	<ul style="list-style-type: none"> <li>Used to:               <ul style="list-style-type: none"> <li>complete rows</li> <li>separate devices.</li> </ul> </li> <li>Width: 1 x 9 mm module</li> <li>Allows cable routing from one row to another, (above and below), up to 6 mm<sup>2</sup></li> </ul>
<b>Catalogue numbers</b>	<b>A9A26982</b>	<b>A9A26981</b>	<b>A9A26975</b>	<b>A9A26976</b>	<b>A9A27001</b>	<b>A9A27062</b>
<b>Set of</b>	<b>12 x 1 pole</b>	<b>20 x 4 poles (splittable)</b>	<b>2 x 1 pole</b>	<b>2 x 2 poles</b>	<b>10</b>	<b>5</b>
<b>Suitability</b>						
iC60	-	■	■	■	■	■
iSW Acti 9	-	-	■	■	■	■
Vigi iC60	■	-	-	-	-	■
iID	-	■	-	■	■	■
iDPN Vigi	-	-	-	-	-	■
iSW-NA	-	■	-	■	■	■

		Connection			
Accessories	Multi-cable terminal		50 mm <sup>2</sup> terminal Al	Screw-on connection for ring terminal	
					
<b>Function</b>					
	For 3 copper cables: ■ Rigid up to 16 mm <sup>2</sup> ■ Flexible up to 10 mm <sup>2</sup>		For aluminium cables from 16 to 50 mm <sup>2</sup>	For lug tipped cables, front or rear mounting	
					
Catalogue numbers	19091	19096	27060	27053	
Set of	4	3	1	8	
<b>Suitability</b>					
iC60 ≤ 25 A	–	–	–	■	
iC60 > 25 A, iSW Acti 9	■	■	■	■	
Vigi iC60	–	–	–	–	
iID	■	■	■	■	
iDPN Vigi	–	–	–	■	
iSW-NA	■	■	■	■	
Tightening torque	2 N.m		10 N.m	2 N.m	
Length stripping	11 mm		13 mm	–	
Tools to use	Dia. 5 mm or PZ2		Hc 1/5" or 5 mm	Dia. 5mm	

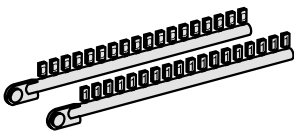
		Marking					
Accessories	Marker strip						
							
<b>Used for connection identification</b>							
Catalogue numbers	0: AB1-R0 1: AB1-R1 2: AB1-R2 3: AB1-R3 4: AB1-R4	5: AB1-R5 6: AB1-R6 7: AB1-R7 8: AB1-R8 9: AB1-R9	A: AB1-GA B: AB1-GB C: AB1-GC D: AB1-GD E: AB1-GE F: AB1-GF G: AB1-GG H: AB1-GH I: AB1-GI	J: AB1-GJ K: AB1-GK L: AB1-GL M: AB1-GM N: AB1-GN O: AB1-GO P: AB1-GP Q: AB1-GQ R: AB1-GR	S: AB1-GS T: AB1-GT U: AB1-GU V: AB1-GV W: AB1-GW X: AB1-GX Y: AB1-GY Z: AB1-GZ	+ : AB1-R12 - : AB1-R13 Blank: AB1-RV	
Set of	250						
<b>Suitability</b>							
iC60, iSW Acti 9	■ 4 markers max. per pole						
Vigi iC60	■ 4 markers max. per device						
iID	■ 4 markers max. per device						
iDPN Vigi	■ 4 markers max. per device						
iSW-NA	■ 4 markers max. per device						

## Dimensions (mm)

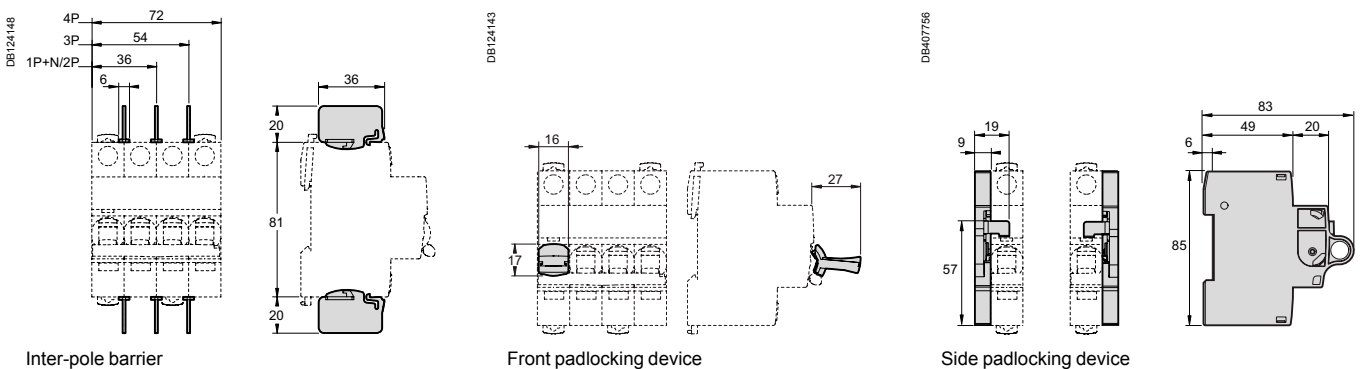
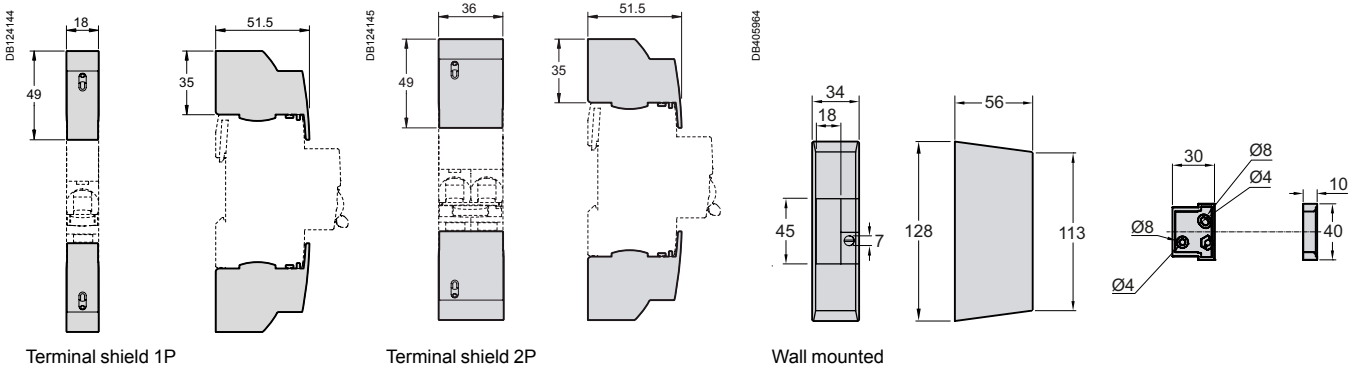
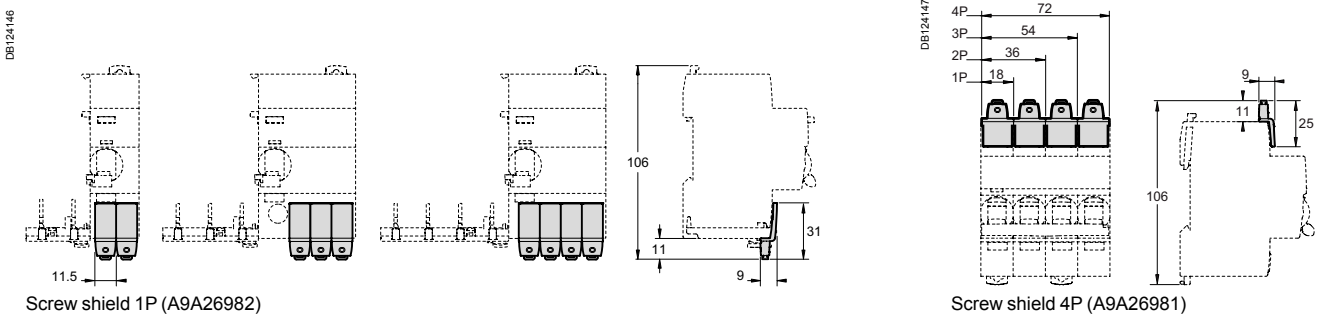
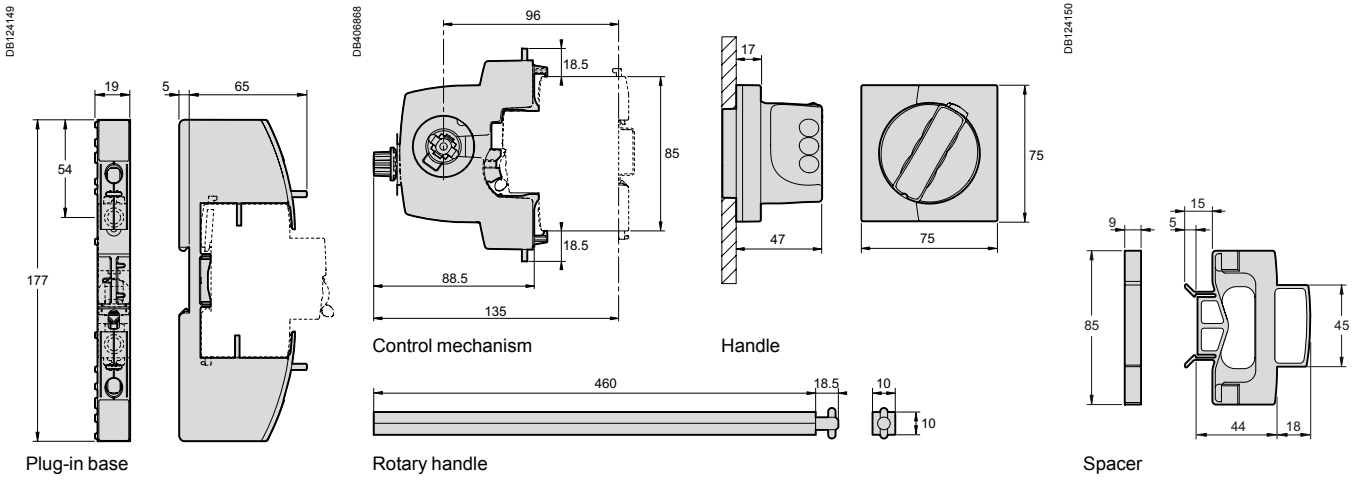

## Rotary handle installation

### Dimensions (mm)

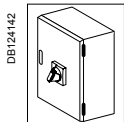

iC60	Z (mm)
2P	25.3
2P + Vigi	25.3
3P	25.3
3P + Vigi	43
4P	43
4P + Vigi	43

iID	Z (mm)
2P	25.3
4P	25.3

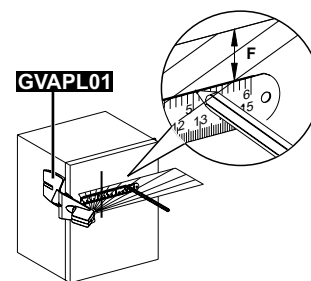
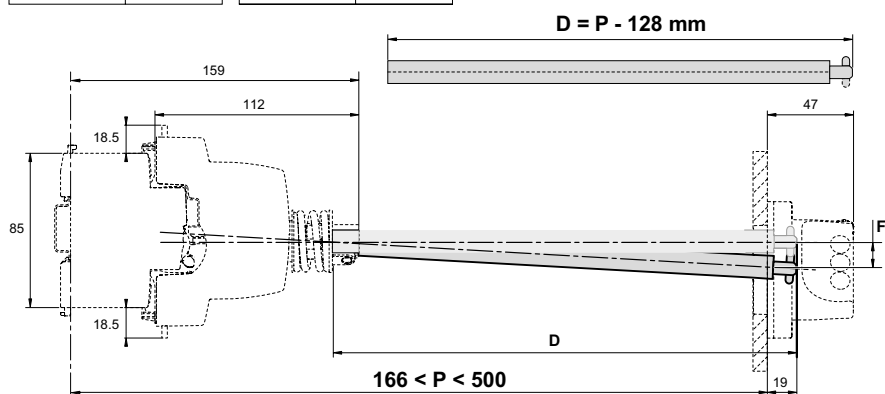
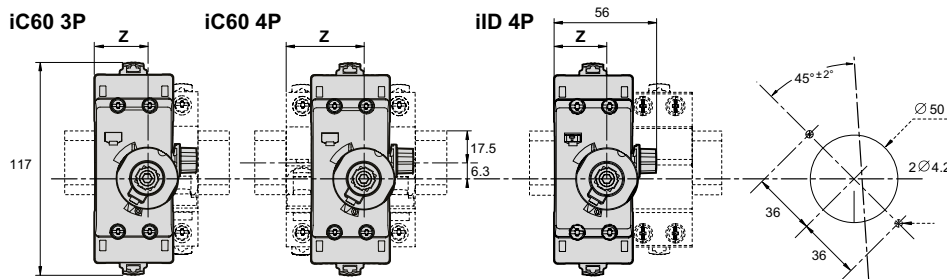

P (mm)	F (mm)
300	5
500	11

Rotary handle: front mounted control

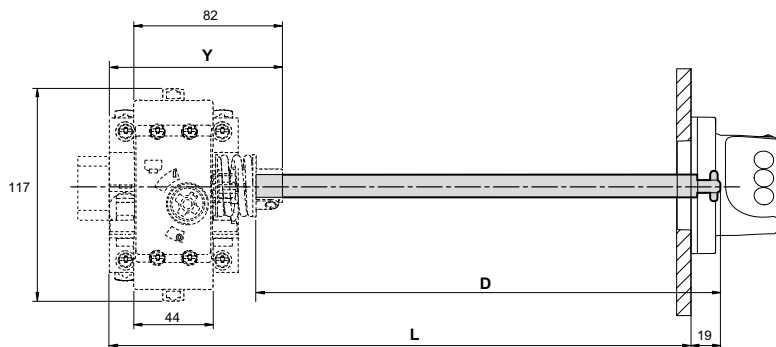
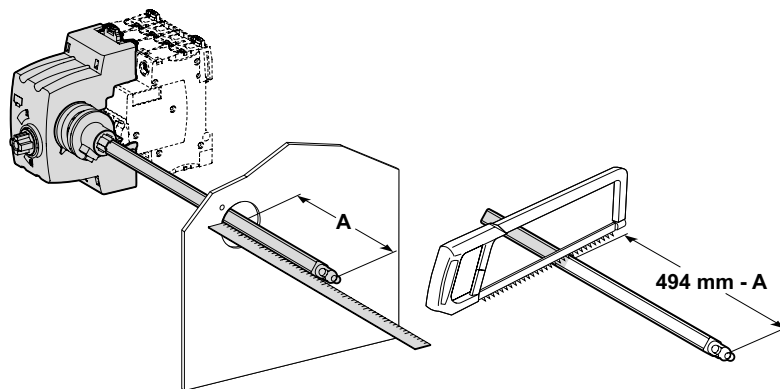
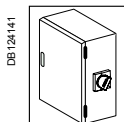



iC60	X (mm)	Y (mm)
2P	44.5	76.8
2P + Vigi	44.5	76.8
3P	44.5	76.8
3P + Vigi	62	94.5
4P	62	94.5
4P + Vigi	62	94.5

iID/iSW-NA	X (mm)	Y (mm)
2P	44.5	76.8
4P	44.5	76.8







Rotary handle: side mounted control

# Accessories for C120, C60H- DC, iSW, DPN N Vigi devices











		Installation					
Accessories		Rotary handle		Plug-in base		Padlocking device	
							
<b>Function</b>		<p><b>Front or side control of 2, 3 and 4-pole circuit breakers</b></p> <ul style="list-style-type: none"> <li>■ Degree of protection: IP40</li> <li>■ A complete rotary handle consists of:               <ul style="list-style-type: none"> <li>□ a circuit-breaker operating sub-assembly, cat. no. <b>27046</b>,</li> <li>□ a handle cat. no. <b>27047</b> or a handle cat. no. <b>27048</b></li> </ul> </li> <li>■ Installation:               <ul style="list-style-type: none"> <li>□ the circuit-breaker operating sub-assembly cat. no. <b>27046</b> is fixed to the circuit breaker</li> <li>□ the removable handle cat. no. <b>27047</b> is mounted on the removable front panel or on the enclosure door</li> <li>□ the fixed handle cat. no. <b>27048</b> is fixed to the front or side panel of the enclosure</li> </ul> </li> </ul>		<p><b>Allows a circuit breaker to be quickly removed or replaced, without touching the connections</b></p> <ul style="list-style-type: none"> <li>■ Degree of protection: IP20</li> <li>■ It consists of:               <ul style="list-style-type: none"> <li>□ a base to be fixed to a rail (or panel)</li> <li>□ 2 "blades" to be fixed in the device terminals</li> </ul> </li> <li>■ Connection: tunnel terminals for cables up to 50 mm<sup>2</sup> (rigid) or 35 mm<sup>2</sup> (flexible)</li> <li>■ Installation:               <ul style="list-style-type: none"> <li>□ on backplate</li> <li>□ on a horizontal rail</li> <li>■ Centreline between two rows: 200 mm</li> <li>■ Only on the circuit breaker, without a Vigi device or auxiliary</li> <li>■ Padlocking option (8 mm dia. padlock not supplied)</li> </ul> </li> </ul>		<p><b>Used to padlock a circuit breaker in the "open" or "closed" position</b></p> <ul style="list-style-type: none"> <li>■ Diameter of the padlock: 8 mm max.</li> <li>■ Locking in the ON position does not prevent the circuit breaker from tripping in the event of a fault</li> <li>■ Isolation: in conformity with IEC/EN 60947-2.</li> </ul>	
<b>Cat. numbers</b>	<b>27047</b> Removable extended handle	<b>27048</b> Fixed handle	<b>27046</b> Operating sub-assembly	<b>26996</b> (1 per pole)	<b>26997</b> (1 per pole)	<b>27145</b>	<b>26970</b>
<b>Set of</b>	1	1	1	1	1	4	2
<b>Suitable for the following devices:</b>							
<b>C120</b>	■ 2P, 3P, 4P			–	■ ≤ 63 A	■	–
<b>C120 + Vigi C120</b>	■ 2P, 3P, 4P			–	–	■	–
<b>C60H-DC</b>	■ 2P			■	–	–	■
<b>iSW</b>	■ iSW ≥ at 4 modules of 9 mm			■ iSW 40 to 63 A	–	–	■
<b>DPN N Vigi</b>	■			–	–	–	■



# Accessories for C120, C60H- DC, iSW, DPN N Vigi devices (cont.)

Safety								
Accessories	Screw shield		Terminal shield			Interpole barrier	Spacer	
								
<b>Function</b>	<b>Prevents all contact with the fixing screws</b> <ul style="list-style-type: none"> <li>■ The degree of protection becomes IP40</li> <li>■ Sealable, max. diameter 1.2 mm</li> <li>■ Dividable</li> </ul>		<b>Prevents all contact with the terminals</b> <ul style="list-style-type: none"> <li>■ Degree of protection becomes IP40</li> <li>■ Sealable, max. diameter 1.2 mm</li> </ul>			<b>Improves the insulation between the connections: cables, terminals, lugs, etc.</b>		<ul style="list-style-type: none"> <li>■ Used to:               <ul style="list-style-type: none"> <li>□ complete the rows</li> <li>□ separate the devices</li> </ul> </li> <li>■ Width: 1 x 9 mm module</li> <li>■ Allows that 2 cables are routed from one row to another (above and below), up to 6 mm<sup>2</sup></li> </ul>
<b>Cat. numbers</b>	18527	26981	18526	26975	26976	27001	A9N27062	
<b>Set of</b>	2 (4P dividable)		2 (for upstream/downstream terminal)			10	1	
<b>Suitable for the following devices:</b>								
<b>C120</b>	■	–	■	–	–	■	■	
<b>Vigi C120</b>	–	–	–	–	–	–	■	
<b>C60H-DC</b>	–	■	–	■	■	■	■	
<b>iSW</b>	–	■ iSW 40 to 125 A	–	■ iSW 40 to 125 A	■ iSW 40 to 125 A	■ iSW 40 to 125 A	■	
	–	–	–	–	–	–	■	

# Accessories for C120, C60H- DC, iSW, DPN N Vigi devices (cont.)

		Connection				
Accessories	Multi-cable terminal	50 mm <sup>2</sup> Al terminal	Screw-on connection for ring terminal	Connection kit for ring terminals	Terminal for rear connector	
						
Function		<b>For 3 copper cables:</b> ■ Rigid up to 16 mm <sup>2</sup> ■ Flexible up to 10 mm <sup>2</sup>	<b>For 16 to 50 mm<sup>2</sup> aluminium cables</b>  Al	<b>For lug tipped cables, front or rear mounting</b>  Ø 5 mm	<b>For terminal up to 63 A, front or rear access (screw Ø 5 mm)</b> ■ It incorporates a "conductive" part and an "insulating" part which ensures the phase-to-phase clearance	<b>For cable up to 50 mm<sup>2</sup> or by terminal</b> ■ Supplied with a 1P terminal shield
						
<b>Cat. numbers</b>	19091	19096	27060	27053	17400	18528
<b>Set of</b>	4	3	1	8	2	2
<b>Suitable for the following devices:</b>						
<b>C120</b>	■	■	■	■	-	■
<b>Vigi C120</b>	■	■	■	-	-	-
<b>C60H-DC, iSW 40 to 125 A</b>	■	■	■	■	■	-
<b>C60NA-DC</b>	■	■	■	■	-	-
<b>DPN N Vigi</b>	-	-	-	■	-	-
<b>Tightening torque</b>	2 N.m		10 N.m	2 N.m	-	-
<b>Stripping length</b>	11 mm		13 mm	-	-	-
<b>Tools to be used</b>	Diameter 5 mm or PZ2		Hc 1/5" or 5 mm	Diameter 5 mm	Diameter 5 mm	13 mm spanner

		Identification	
Accessories	Clip-on terminal marker strip		
			
Function		<b>For connection identification</b>	
<b>Cat. numbers</b>		0: AB1-R0 1: AB1-R1 2: AB1-R2 3: AB1-R3 4: AB1-R4 5: AB1-R5 6: AB1-R6 7: AB1-R7 8: AB1-R8 9: AB1-R9	A: AB1-GA B: AB1-GB C: AB1-GC D: AB1-GD E: AB1-GE F: AB1-GF G: AB1-GG H: AB1-GH I: AB1-GI J: AB1-GJ
		K: AB1-GK L: AB1-GL M: AB1-GM N: AB1-GN O: AB1-GO P: AB1-GP Q: AB1-GQ R: AB1-GR S: AB1-GS T: AB1-GT	U: AB1-GU V: AB1-GV W: AB1-GW X: AB1-GX Y: AB1-GY Z: AB1-GZ +: AB1-R12 -: AB1-R13 Blank: AB1-RV
<b>Set of</b>		250	
<b>Suitable for the following devices:</b>			
<b>C120</b>	■ 4 markers max. per pole		
<b>Vigi C120</b>	■ 4 markers max. per device		
<b>C60H-DC</b>	■ 4 markers max. per pole		
<b>iSW</b>	-		
<b>DPN N Vigi</b>	■ 4 markers max. per pole		



04000	97	A9A26982	100
04040	96	A9A27001	100
04041	96	A9A27003	98
10405	93	A9A27005	98
15111	63	A9A27006	98
15228	88	A9A27008	98
15229	88	A9A27052	98
15359	98	A9A27062	75, 76, 80, 100
15668	69	A9C20731	74
15669	69	A9C20732	74
16315	47, 48	A9C20834	74
16316	47, 48	A9C20842	74
16317	47, 48	A9C21732	74
16329	47, 48	A9C21833	74
16330	47, 48	A9C21834	74
16331	47, 48	A9C22712	74
16332	47, 48	A9C30811	78
16905	7	A9C30812	78
16907	7	A9C70112	26
16940	7	A9C70114	26
17400	106	A9D31606	18
18526	104	A9D31610	18
18527	104	A9D31616	18
18528	106	A9D31620	18
19091	101, 106	A9D31625	18
19096	101, 106	A9D31632	18
19512	93	A9D31640	18
19516	93	A9D31716	18
21089	93	A9D31720	18
21093	93	A9D31725	18
21094	93	A9D31732	18
21095	93	A9D31740	18
21096	93	A9D33610	18
21098	93	A9D33616	18
21501	93	A9D33620	18
21503	93	A9D33716	18
21505	93	A9D33720	18
21507	93	A9D33725	18
26970	104	A9D33732	18
26975	104	A9D33740	18
26976	104	A9E15535	83
26981	104	A9E16065	82
26996	104	A9E18032	91
26997	104	A9E18070	65
27001	104	A9E18071	65
27046	104	A9E18072	65
27047	104	A9E18073	65
27048	104	A9E18074	65
27053	69, 101, 106	A9E18320	86
27060	101, 106	A9E21180	84
27145	104	A9F74102	9
A		A9F74103	9
A9A15096	63	A9F74104	9
A9A15215	88, 89	A9F74106	9
A9A15216	88, 89	A9F74110	9
A9A15222	88, 89	A9F74116	9
A9A15306	90	A9F74120	9
A9A15310	90	A9F74125	9
A9A15320	87	A9F74132	9
A9A15921	75, 76	A9F74140	9
A9A15922	75, 76	A9F74150	9
A9A26380	98	A9F74163	9
A9A26381	98	A9F74201	9
A9A26476	22	A9F74202	9
A9A26477	22	A9F74203	9
A9A26478	22	A9F74204	9
A9A26500	22	A9F74206	9
A9A26924	24, 59	A9F74210	9
A9A26927	24	A9F74216	9
A9A26929	24	A9F74220	9
A9A26946	22	A9F74225	9
A9A26948	22	A9F74232	9
A9A26960	22	A9F74240	9
A9A26969	22	A9F74250	9
A9A26970	98	A9F74263	9
A9A26975	100	A9F74301	9
A9A26976	100	A9F74302	9
A9A26981	100	A9F74303	9

A9F74304	9	A9F84106	10
A9F74306	9	A9F84110	10
A9F74310	9	A9F84116	10
A9F74316	9	A9F84120	10
A9F74320	9	A9F84125	10
A9F74325	9	A9F84132	10
A9F74332	9	A9F84140	10
A9F74340	9	A9F84150	10
A9F74350	9	A9F84163	10
A9F74363	9	A9F84301	10
A9F74401	9	A9F84302	10
A9F74402	9	A9F84303	10
A9F74403	9	A9F84304	10
A9F74404	9	A9F84306	10
A9F74406	9	A9F84310	10
A9F74410	9	A9F84316	10
A9F74416	9	A9F84320	10
A9F74420	9	A9F84325	10
A9F74425	9	A9F84332	10
A9F74432	9	A9F84340	10
A9F74440	9	A9F84350	10
A9F74450	9	A9F84363	10
A9F74463	9	A9F94101	11
A9F75101	9	A9F94102	11
A9F75102	9	A9F94103	11
A9F75103	9	A9F94104	11
A9F75104	9	A9F94106	11
A9F75106	9	A9F94110	11
A9F75110	9	A9F94116	11
A9F75116	9	A9F94120	11
A9F75120	9	A9F94125	11
A9F75125	9	A9F94132	11
A9F75132	9	A9F94140	11
A9F75140	9	A9F94150	11
A9F75150	9	A9F94163	11
A9F75163	9	A9F94201	11
A9F75201	9	A9F94202	11
A9F75202	9	A9F94203	11
A9F75203	9	A9F94204	11
A9F75204	9	A9F94206	11
A9F75206	9	A9F94210	11
A9F75210	9	A9F94216	11
A9F75216	9	A9F94220	11
A9F75220	9	A9F94225	11
A9F75225	9	A9F94232	11
A9F75232	9	A9F94240	11
A9F75240	9	A9F94250	11
A9F75250	9	A9F94263	11
A9F75263	9	A9F94301	11
A9F75301	9	A9F94302	11
A9F75302	9	A9F94303	11
A9F75303	9	A9F94304	11
A9F75304	9	A9F94306	11
A9F75306	9	A9F94310	11
A9F75310	9	A9F94316	11
A9F75316	9	A9F94320	11
A9F75320	9	A9F94325	11
A9F75325	9	A9F94332	11
A9F75332	9	A9F94340	11
A9F75340	9	A9F94350	11
A9F75350	9	A9F94363	11
A9F75363	9	A9F94401	11
A9F75401	9	A9F94402	11
A9F75402	9	A9F94403	11
A9F75403	9	A9F94404	11
A9F75404	9	A9F94406	11
A9F75406	9	A9F94410	11
A9F75410	9	A9F94416	11
A9F75416	9	A9F94420	11
A9F75420	9	A9F94425	11
A9F75425	9	A9F94432	11
A9F75432	9	A9F94440	11
A9F75440	9	A9F94450	11
A9F75450	9	A9F94463	11
A9F75463	9	A9K24102	31
A9F84102	10	A9K24106	31
A9F84103	10	A9K24110	31
A9F84104	10	A9K24116	31

A9K24320.....	31	A9N61504.....	38
A9K24325.....	31	A9N61505.....	38
A9K24332.....	31	A9N61506.....	38
A9L00002.....	51	A9N61508.....	38
A9L08100.....	51	A9N61509.....	38
A9L08102.....	51	A9N61510.....	38
A9L08300.....	51	A9N61511.....	38
A9L08501.....	51	A9N61512.....	38
A9L08601.....	51	A9N61513.....	38
A9L15597.....	55	A9N61514.....	38
A9L15691.....	55	A9N61515.....	38
A9L15692.....	55	A9N61517.....	38
A9L15693.....	55	A9N61518.....	38
A9L16434.....	56	A9N61519.....	38
A9L16436.....	56	A9N61520.....	38
A9L16632.....	47, 48	A9N61521.....	38
A9L16633.....	47, 48	A9N61522.....	38
A9L16634.....	47, 48	A9N61523.....	38
A9L16683.....	56	A9N61524.....	38
A9L16690.....	56	A9N61525.....	38
A9L16692.....	56	A9N61526.....	38
A9L40101.....	51	A9N61528.....	38
A9L40102.....	51	A9N61529.....	38
A9L40301.....	51	A9N61530.....	38
A9L40500.....	51	A9N61531.....	38
A9L40601.....	51	A9N61532.....	38
A9L65101.....	51	A9N61533.....	38
A9L65102.....	51	A9N61534.....	38
A9L65301.....	51	A9N61535.....	38
A9L65501.....	51	A9N61537.....	38
A9L65601.....	51	A9N61538.....	38
A9N15635.....	68	A9N61539.....	38
A9N15636.....	68	A9R11280.....	4
A9N15646.....	68	A9R11291.....	4
A9N15651.....	68	A9R11480.....	4
A9N15656.....	68	A9R11491.....	4
A9N15658.....	68	A9R14280.....	4
A9N18446.....	33	A9R14291.....	4
A9N18447.....	33	A9R14480.....	4
A9N18448.....	33	A9R14491.....	4
A9N18457.....	33	A9R15263.....	4
A9N18458.....	33	A9R15280.....	4
A9N18459.....	33	A9R15291.....	4
A9N18468.....	33	A9R15463.....	4
A9N18469.....	33	A9R15480.....	4
A9N18470.....	33	A9R15491.....	4
A9N18479.....	33	A9R50225.....	29
A9N18480.....	33	A9R50240.....	29
A9N18481.....	33	A9R50425.....	29
A9N18490.....	33	A9R50440.....	29
A9N18491.....	33	A9R70463.....	29
A9N18492.....	33	A9R71225.....	4
A9N18501.....	33	A9R71240.....	4
A9N18502.....	33	A9R71263.....	4
A9N18503.....	33	A9R71425.....	4
A9N18512.....	33	A9R71440.....	4
A9N18513.....	33	A9R71463.....	4
A9N18514.....	33	A9R74263.....	4
A9N18523.....	33	A9R74463.....	4
A9N18524.....	33	A9R91263.....	4
A9N18525.....	33	A9R91463.....	4
A9N18563.....	36	A9S60120.....	62
A9N18564.....	36	A9S60132.....	62
A9N18566.....	36	A9S60220.....	62
A9N18567.....	36	A9S60232.....	62
A9N18569.....	36	A9S60320.....	62
A9N18570.....	36	A9S60332.....	62
A9N26476.....	42	A9S60420.....	62
A9N26924.....	43	A9S60432.....	62
A9N26927.....	43	A9S61120.....	63
A9N26929.....	43	A9S61132.....	63
A9N26946.....	42	A9S61220.....	63
A9N26960.....	42	A9S61232.....	63
A9N27062.....	104	A9S65140.....	59
A9N61500.....	38	A9S65340.....	59
A9N61501.....	38	A9S65363.....	59
A9N61502.....	38	A9S65440.....	59
A9N61503.....	38	A9S70740.....	66

A9V01225.....	14	AB1-R7.....	101, 106
A9V01263.....	14	AB1-R8.....	101, 106
A9V04225.....	14	AB1-R9.....	101, 106
A9V04263.....	14	AB1-R12.....	101, 106
A9V15263.....	14	AB1-R13.....	101, 106
A9V15363.....	14	AB1-RV.....	101, 106
A9V15463.....	14	DF2BA0200.....	68
A9V41225.....	14	DF2BA0400.....	68
A9V41263.....	14	DF2BA0600.....	68
A9V41325.....	14	DF2BA0800.....	68
A9V41363.....	14	DF2BA1000.....	68
A9V41425.....	14	DF2BN0200.....	68
A9V41463.....	14	DF2BN0400.....	68
A9V44225.....	14	DF2BN0600.....	68
A9V44263.....	14	DF2BN0800.....	68
A9V44325.....	14	DF2BN1000.....	68
A9V44363.....	14	DF2CA02.....	68
A9V44425.....	14	DF2CA04.....	68
A9V44463.....	14	DF2CA06.....	68
A9V61263.....	15	DF2CA10.....	68
A9V61363.....	15	DF2CA16.....	68
A9V61463.....	15	DF2CN02.....	68
A9V65263.....	15	DF2CN04.....	68
A9V65363.....	15	DF2CN06.....	68
A9V65463.....	15	DF2CN10.....	68
A9XPCM04.....	92	DF2CN16.....	68
A9XPE110.....	92	DF2CN20.....	68
A9XPE210.....	92	DF2CN25.....	68
A9XPE310.....	92	DF2EA10.....	71
A9XPE410.....	92	DF2EA12.....	71
A9XPH106.....	92	DF2EA16.....	71
A9XPH112.....	92	DF2EA20.....	71
A9XPH124.....	92	DF2EA25.....	71
A9XPH157.....	92	DF2EA32.....	71
A9XPH212.....	92	DF2EA40.....	71
A9XPH224.....	92	DF2EA50.....	71
A9XPH257.....	92	DF2EN10.....	71
A9XPH306.....	92	DF2EN16.....	71
A9XPH312.....	92	DF2EN20.....	71
A9XPH324.....	92	DF2EN25.....	71
A9XPH357.....	92	DF2EN32.....	71
A9XPH412.....	92	DF2EN40.....	71
A9XPH424.....	92	DF2EN50.....	71
A9XPH457.....	92	DF2FA32.....	71
A9XPT920.....	92	DF2FA40.....	71
AB1-GA.....	101, 106	DF2FA50.....	71
AB1-GB.....	101, 106	DF2FA63.....	71
AB1-GC.....	101, 106	DF2FA80.....	71
AB1-GD.....	101, 106	DF2FA100.....	71
AB1-GE.....	101, 106	DF2FA125.....	71
AB1-GF.....	101, 106	DF2FN32.....	71
AB1-GG.....	101, 106	DF2FN40.....	71
AB1-GH.....	101, 106	DF2FN50.....	71
AB1-GI.....	101, 106	DF2FN63.....	71
AB1-GJ.....	101, 106	DF2FN80.....	71
AB1-GK.....	101, 106	DF2FN100.....	71
AB1-GL.....	101, 106	G.....	
AB1-GM.....	101, 106	GVAPL01.....	98
AB1-GN.....	101, 106	L.....	
AB1-GO.....	101, 106	LGY410028.....	94
AB1-GP.....	101, 106	LGY416048.....	94
AB1-GQ.....	101, 106	M.....	
AB1-GR.....	101, 106	MGN15707.....	71
AB1-GS.....	101, 106	MGN15709.....	71
AB1-GT.....	101, 106	MGN15710.....	71
AB1-GU.....	101, 106	MGN15711.....	71
AB1-GV.....	101, 106	MGN15713.....	71
AB1-GW.....	101, 106	MGN15715.....	71
AB1-GX.....	101, 106	MGN15716.....	71
AB1-GY.....	101, 106	MGN15717.....	71
AB1-GZ.....	101, 106		
AB1-R0.....	101, 106		
AB1-R1.....	101, 106		
AB1-R2.....	101, 106		
AB1-R3.....	101, 106		
AB1-R4.....	101, 106		
AB1-R5.....	101, 106		
AB1-R6.....	101, 106		

Schneider Electric Industries SAS  
35, rue Joseph Monier - CS 30323  
F-92506 Rueil-Malmaison - FRANCE  
Phone: + 33 (0) 1 41 29 70 00  
Fax: + 33 (0) 1 41 29 71 00  
[www.schneider-electric.com](http://www.schneider-electric.com)

08-2017  
Document Number CA909006EN

©2017 Schneider Electric. All Rights Reserved.  
All trademarks are owned by Schneider Electric Industries SAS or its affiliated companies.

This document has been  
printed on recycled paper

