

Product data sheet Spirotech

Product name

Secondary vessel 5000L for EMCM, ETCM

Product properties

Secondary expansion vessels for EMCM and ETCM, P max. 0,5 bar / T max. 70°C, without level measurement

Article number

EP5000RS

Product image



Product dimensions

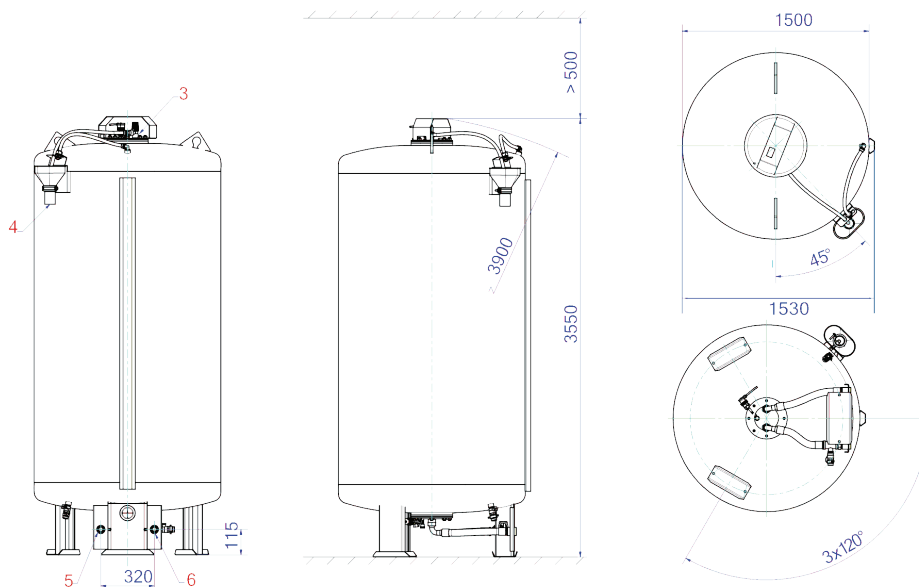

Product data sheet Spirotech

ETIM product data

Height	3550 mm
Volume	5000 l
Colour	Other
Diameter	1500 mm
Medium temperature (continuous)	0 - 70 °C
Max. operating pressure	0.5 bar
With pressure gauge	No
With exchangeable membrane	Yes
Nominal diameter expansion connection	1 1/2 inch (40)
Horizontal positioning	No
Suitable for central heating	Yes
Vertical positioning	Yes
With legs	Yes

Material membrane/bladder	Other
Flange compression class	Other
With drain	Yes
Tilting height	3720 mm
With safety valve	Yes
Max. glycol mixture	60 %
Suitable for tap water	No
Max. ethanol mixture	60 %
Suitable for solar collector circuit	Yes
Pre-pressure	0 bar
With fixed wall support	No
Suitable for cooling	No

Disclaimer

This product sheet has been compiled with the greatest possible care. Nevertheless, it may contain errors or omissions. For the most current and correct information we refer you to our website

