















20 713 892 Product version from 6/30/2009



- 165mm projection
- pivotable spout 360°
- circular, air-enriched flow
- height of mixer 285 mm
- height up to aerator 163 mm
- hole diameter valve 32 mm
- hole diameter spout 35 mm
- rosette Ø 55 mm
- 2x screw-in M 10 x 1 pressure hose, leak-tested
- max. flow 7 l/min
- lead-free
- WRAS
- This product can help a building meet the requirements of Green Building Rating Systems, e.g. LEED®, BREEAM®, DGNB

Only suitable for basins with an overflow.

	Brushed Dark Platinum	20 713 892-99
	Chrome	20 713 892-00
	Brushed Platinum	20 713 892-06
	Platinum	20 713 892-08
	Dark Chrome	20 713 892-19
	Brushed Durabronze (23kt Gold)	20 713 892-28
	Matte Black	20 713 892-33
	Brushed Gold (PVD)	20 713 892-37
	Brushed Dark Brass (PVD)	20 713 892-39
	Brushed Bronze (PVD)	20 713 892-42
	Brushed Dark Bronze (PVD)	20 713 892-43
	Brushed Champagne (22kt Gold)	20 713 892-46
	Champagne (22kt Gold)	20 713 892-47
	Brushed Chrome	20 713 892-93

Recommended miscellaneous



High pressure hoses - 12 506 970 90
 • 2x 3/8" x 1/2" x 500mm high pressure hose

20 713 892 Product version from 6/30/2009

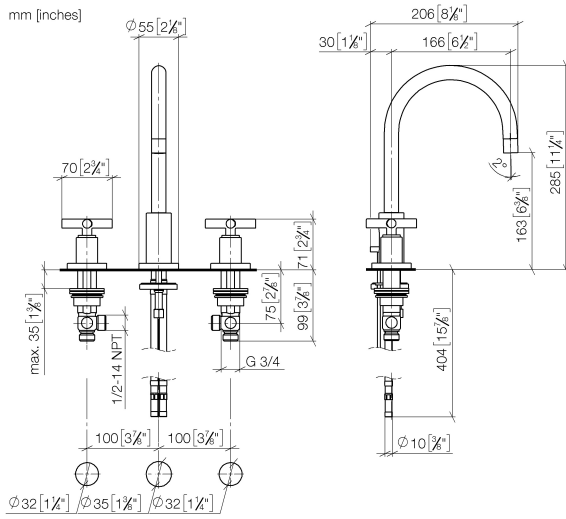

Flow rate chart

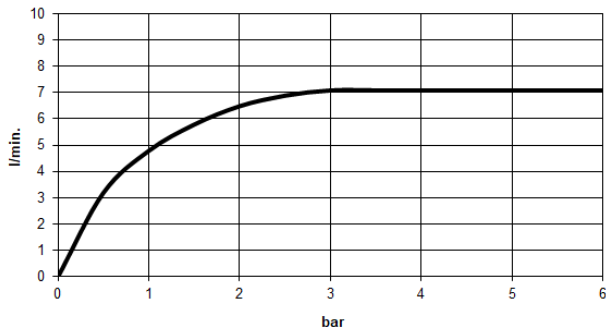

Codes & Standards

DIN 4109	EN 200	Executive Order no. 1007	ISO 3822
Scottish Water Byelaws	UK Water Supply Regulations	Ü-Zeichen	VA-Zeichen
XP P 41-280			



TARA Three-hole basin mixer with pop-up waste - Brushed Dark Platinum

TARA

20 713 892 Product version from 6/30/2009

Certificates and sustainability

LGA_18

ETA_18

WRAS_2212

ACS_20 ACC LY

GDV_0400

EPD-DOR-20230287

-IBA1-EN

Environmental.prod

uct-declarat

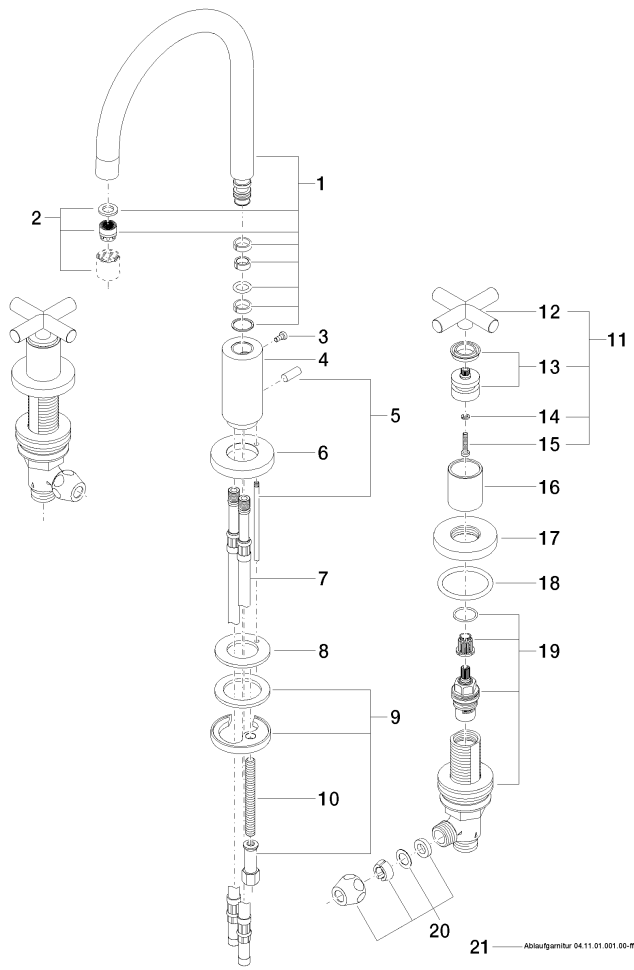

Spare parts list

No.	Item Number	Name	Quantity used	Delivery time
20	90 23 30 040 00-99	Union piece - Brushed Dark Platinum	2.00	40
15	90 30 30 075 00 90	Mounting Cylinder head screw with hexagon socket Low profile M4 x 20 mm -	2.00	14
18	90 14 10 043 00 90	O-Ring 40,0 x 4,0 mm -	2.00	14
10	09 31 11 011 90	Mounting Threaded bolt M8 x 80 mm -	1.00	14
9	04 30 11 038 00 90	Mounting with O-ring Ø40 x 4mm Ø 52 x 1,5 mm -	1.00	14
7	04 30 04 019 00 90	High pressure hose with sleeve nut M10x1 x 1/2" x 420 mm -	2.00	14
17	09 27 89 105-99	Rosette Ø 55 x Ø 47,3 x 9 mm - Brushed Dark Platinum	2.00	40
2	90 23 01 028 02-99	Aerator low pressure M18xIG - Brushed Dark Platinum	1.00	-
Spare part can no longer be ordered, please order the replacement item				
11	90 20 89 010 10-99	Handle TARA - Brushed Dark Platinum	2.00	40
1	90 28 22 213 00-99	Spout 165 mm, 8,33 l/min. - Brushed Dark Platinum	1.00	-
Spare part can no longer be ordered, please order the replacement item				
5	04 20 89 030 80-99	Pull rod for pop-up waste with button 17 x 158 x 7 mm - Brushed Dark Platinum	1.00	40
19	90 17 11 040 51 90	Deck valve clockwise closing 1/2" -	2.00	14
13	90 12 12 007 00-99	Handle Socket retainer Ø 29 x 26 mm - Brushed Dark Platinum	2.00	40
4	09 11 10 087 10-99	Connection Ø 35 x 79 mm - Brushed Dark Platinum	1.00	40
21	90 11 01 001 00-99	Basin Waste - Brushed Dark Platinum	1.00	40
6	09 28 10 133-99	Rosette Ø 59 x Ø 27,5 x 9 mm - Brushed Dark Platinum	1.00	40
3	09 30 30 057 90	Mounting Cylinder head screw with hexagon socket with low profile M4 x 8 mm -	1.00	14
14	90 30 11 029 00 90	Connection Spring lock washer Ø 4 -	2.00	14
16	09 21 02 140-99	Cover Ø 30 x 36 mm - Brushed Dark Platinum	2.00	40
8	09 14 05 047 90	Washer with drill hole Ø 48 x 27,2 x 3 mm -	1.00	14
12	09 20 89 010-99	Handle 70 x 70 x 22,5 mm - Brushed Dark Platinum	2.00	-
Spare part can no longer be ordered, please order the replacement item				
	90208901010-99	Handle TARA - Brushed Dark Platinum		