

## Data Sheet | Item Number: 2050-1206

2-conductor miniature through terminal block; with operating slots; 1 mm<sup>2</sup>; with test port; side and center marking; for DIN-15 rail; Push-in CAGE CLAMP®; 1,00 mm<sup>2</sup>; yellow

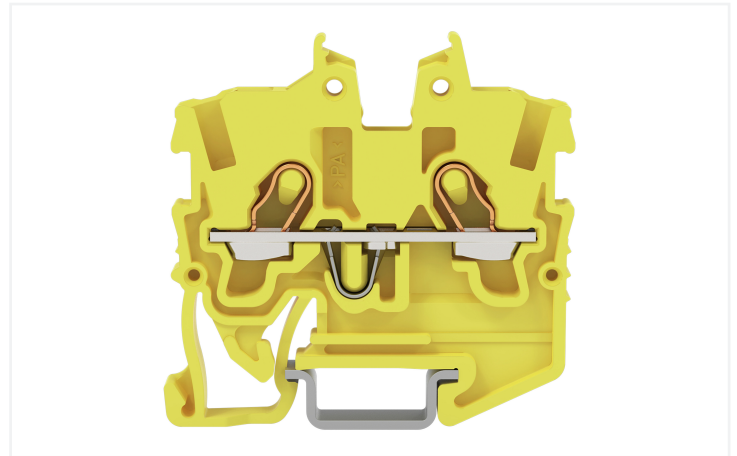

<https://www.wago.com/2050-1206>

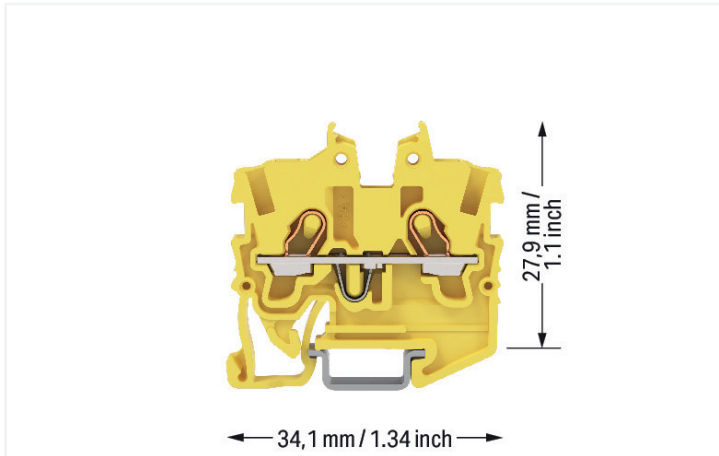

Color: ■ yellow

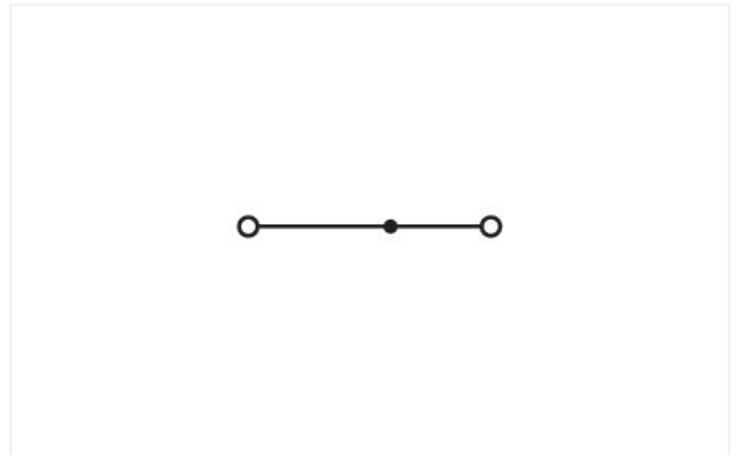
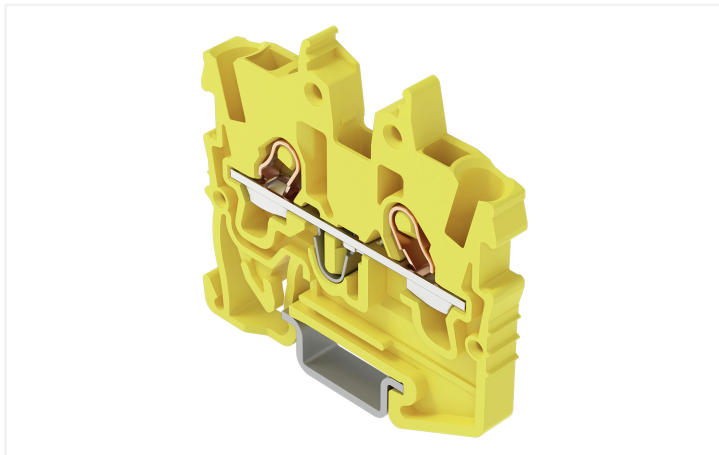

Similar to illustration

### Through terminal block, 2050 Series, Push-in CAGE CLAMP®

This through terminal block (item number 2050-1206) is designed for easy and secure connections. Strip lengths must be between 9 and 11 mm when connecting conductors to this through terminal block. Our mini rail-mount terminal blocks are perfect for tight spaces thanks to their compact design. You can also choose from a range of mounting and actuation variants, making it easy to select the ideal mini terminal block for each use. This product incorporates conductor terminals and utilizes Push-in CAGE CLAMP®. Push-in CAGE CLAMP® connection technology is ideal for connecting all conductor types. Both solid and fine-stranded conductors with ferrules can be plugged in without the need for tools—all thanks to its pluggable design. Depending on the conductor type, this through terminal block is suitable for conductor cross sections ranging from 0.14 mm<sup>2</sup> to 1.5 mm<sup>2</sup>.

This mini rail-mount terminal block is operated with an operating tool. Our TOPJOB® S rail-mount terminal blocks offer more than just secure electrical connections in various industrial applications and modern building installations. They also offer the perfect solution for every use: lever, push-button, or operating slot. This product is designed for specific Ex applications (please refer to the product datasheet).

## Electrical data

Ratings per	IEC/EN 60947-7-1		
Overvoltage category	III	III	II
Pollution degree	3	2	2
Nominal voltage	500 V	-	-
Rated impulse withstand voltage	6 kV	-	-
Rated current	13.5 A	-	-
Current at conductor cross-section (max.) mm <sup>2</sup>	17.5 A	-	-

Approvals per	UL 1059		
Use group	B	C	D
Rated voltage	300 V	300 V	-
Rated current	10 A	10 A	-

Approvals per	CSA 22.2 No 158		
Use group	B	C	D
Rated voltage	300 V	300 V	-
Rated current	10 A	10 A	-

Ex information	
Reference to hazardous areas	See "Downloads – Documentation – Additional Information: Technical Section; Technical Explanations"
Ratings per	ATEX: PTB 19 ATEX 1019 U / IECEx: PTB 19.0050U (Ex eb IIC Gb)
Rated voltage EN (Ex e II)	352 V
Rated current (Ex e II)	13.5 A
Rated current (Ex e II) with jumper	12 A

## Power Loss

Power loss, per pole (potential)	0.4338 W
Rated current $I_N$ for power loss specification	13.5 A
Resistance value for specified, current-dependent power loss	0.00238 $\Omega$

## General information

Wiring direction	Front-entry wiring
------------------	--------------------

## Connection Data

Clamping units	2
Total number of potentials	1
Number of levels	1
Number of jumper slots	1

Connection 1	
Connection technology	Push-in CAGE CLAMP®
Actuation type	Operating tool
Connectable conductor materials	Copper
Nominal cross-section	1 mm <sup>2</sup>
Solid conductor	0.14 ... 1.5 mm <sup>2</sup> / 24 ... 16 AWG
Solid conductor; push-in termination	0.5 ... 1.5 mm <sup>2</sup> / 20 ... 16 AWG
Fine-stranded conductor	0.14 ... 1.5 mm <sup>2</sup> / 24 ... 16 AWG
Fine-stranded conductor; with insulated ferrule	0.14 ... 1 mm <sup>2</sup> / 24 ... 18 AWG
Fine-stranded conductor; with uninsulated ferrule	0.14 ... 1 mm <sup>2</sup> / 24 ... 18 AWG
Fine-stranded conductor; with ferrule; push-in termination	0.5 ... 1 mm <sup>2</sup> / 20 ... 18 AWG
Note (conductor cross-section)	Depending on the conductor characteristic, a conductor with a smaller cross-section can also be inserted via push-in termination.
Strip length	9 ... 11 mm / 0.35 ... 0.43 inches
Wiring direction	Front-entry wiring

### Physical data

Width	3.5 mm / 0.138 inches
Height	34.1 mm / 1.343 inches
Depth from upper-edge of DIN-rail	27.9 mm / 1.098 inches

### Mechanical data

Mounting type	DIN-15 rail
Marking level	Center/side marking

### Material data

Note (material data)	<a href="#">Information on material specifications can be found here</a>
Color	yellow
Material group	I
Insulation material (main housing)	Polyamide (PA66)
Flammability class per UL94	V0
Fire load	0.049 MJ
Weight	2.4 g

### Environmental requirements

Processing temperature	-35 ... +85 °C
Continuous operating temperature	-60 ... +105 °C

### Commercial data

PU (SPU)	100 pcs
Packaging type	Box
Country of origin	IN
GTIN	4066966312737
Customs tariff number	85369010000

### Product Classification

UNSPSC	39121410
ETIM 9.0	EC000897
ETIM 10.0	EC000897
ECCN	NO US CLASSIFICATION

### Environmental Product Compliance

RoHS Compliance Status	Compliant, No Exemption
------------------------	-------------------------

### Approvals / Certificates

#### Approvals for marine applications



Approval	Standard	Certificate Name
DNV DNV GL SE	-	TAE00003JT

#### Approvals for hazardous areas



Approval	Standard	Certificate Name
ATEX Physikalisch Technische Bundesanstalt	EN 60079	PTB 19 ATEX 1019 U
IECEx Physikalisch Technische Bundesanstalt	IEC 60079	IECEx PTB 19.0050U

### Approvals for hazardous areas

INMETRO IEC 60079 TÜV 22.0014 U  
TÜV Rheinland do Brasil  
Ltda.

## Downloads

### Environmental Product Compliance

#### Compliance Search

Environmental Product Compliance 2050-1206

## CAD/CAE-Data

#### CAD data

2D/3D Models 2050-1206

## 1 Compatible Products

### 1.1 Required Accessories

#### 1.1.1 End plate

##### 1.1.1.1 End plate



[Item No.: 2050-1291](#)  
End and intermediate plate; 1.1 mm thick; gray

### 1.2 Optional Accessories

#### 1.2.1 DIN-rail

##### 1.2.1.1 Mounting accessories



[Item No.: 210-111](#)  
Steel carrier rail; 15 x 5.5 mm; 1 mm thick; 2 m long; slotted; according to EN 60715; silver-colored



[Item No.: 210-295](#)  
Steel carrier rail; 15 x 5.5 mm; 1 mm thick; 2 m long; unslotted; according to EN 60715; silver-colored

## 1.2.2 Ferrule

### 1.2.2.1 Ferrule



**Item No.: 216-241**

Ferrule; Sleeve for 0.5 mm<sup>2</sup> / 20 AWG; insulated; electro-tin plated; electrolytic copper; gastight crimped; acc. to DIN 46228, Part 4/09.90; white



**Item No.: 216-242**

Ferrule; Sleeve for 0.75 mm<sup>2</sup> / 18 AWG; insulated; electro-tin plated; electrolytic copper; gastight crimped; acc. to DIN 46228, Part 4/09.90; gray



**Item No.: 216-243**

Ferrule; Sleeve for 1 mm<sup>2</sup> / AWG 18; insulated; electro-tin plated; electrolytic copper; gastight crimped; acc. to DIN 46228, Part 4/09.90; red

## 1.2.3 Installation

### 1.2.3.1 Cover



**Item No.: 709-156**

Cover; Type 3; suitable for cover carrier, type 3; 1 m long; transparent

### 1.2.3.2 Cover carrier



**Item No.: 709-169**

Cover carrier; Type 3; incl. fixing/retaining screws and knurled nut; suitable for 279 to 282 and 880 Series rail-mounted terminal blocks; suitable for 264 Series miniature rail-mounted terminal blocks; suitable for 270 Series sensor and actuator terminal blocks; gray

### 1.2.3.3 Mounting accessories



**Item No.: 249-101**

Screwless end stop; 6 mm wide; for WMB markers; gray

## 1.2.4 Jumper

### 1.2.4.1 Jumper



**Item No.: 2000-406/020-000**

Delta jumper; insulated; light gray



**Item No.: 2000-410/000-006**

Jumper; 10-way; insulated; blue



**Item No.: 2000-410**

Jumper; 10-way; insulated; light gray



**Item No.: 2000-410/000-005**

Jumper; 10-way; insulated; red



**Item No.: 2000-402/000-006**

Jumper; 2-way; insulated; blue



**Item No.: 2000-402**

Jumper; 2-way; insulated; light gray



**Item No.: 2000-402/000-005**

Jumper; 2-way; insulated; red



**Item No.: 2000-402/000-018**

Jumper; 2-way; insulated; yellow-green



**Item No.: 2000-403/000-006**

Jumper; 3-way; insulated; blue



**Item No.: 2000-403**

Jumper; 3-way; insulated; light gray



**Item No.: 2000-403/000-005**

Jumper; 3-way; insulated; red



**Item No.: 2000-404/000-006**

Jumper; 4-way; insulated; blue



**Item No.: 2000-404**

Jumper; 4-way; insulated; light gray



**Item No.: 2000-404/000-005**

Jumper; 4-way; insulated; red



**Item No.: 2000-405/000-006**



























Jumper; 5-way; insulated; blue



**Item No.: 2000-405**

Jumper; 5-way; insulated; light gray

1.2.4.1 Jumper











 <b>Item No.: 2000-405/000-005</b> Jumper; 5-way; insulated; red	 <b>Item No.: 2000-406/000-006</b> Jumper; 6-way; insulated; blue	 <b>Item No.: 2000-406</b> Jumper; 6-way; insulated; light gray	 <b>Item No.: 2000-406/000-005</b> Jumper; 6-way; insulated; red
 <b>Item No.: 2000-407/000-006</b> Jumper; 7-way; insulated; blue	 <b>Item No.: 2000-407</b> Jumper; 7-way; insulated; light gray	 <b>Item No.: 2000-407/000-005</b> Jumper; 7-way; insulated; red	 <b>Item No.: 2000-408/000-006</b> Jumper; 8-way; insulated; blue
 <b>Item No.: 2000-408</b> Jumper; 8-way; insulated; light gray	 <b>Item No.: 2000-408/000-005</b> Jumper; 8-way; insulated; red	 <b>Item No.: 2000-409/000-006</b> Jumper; 9-way; insulated; blue	 <b>Item No.: 2000-409</b> Jumper; 9-way; insulated; light gray
 <b>Item No.: 2000-409/000-005</b> Jumper; 9-way; insulated; red	 <b>Item No.: 2000-440</b> Jumper; from 1 to 10; insulated; light gray	 <b>Item No.: 2000-433/000-006</b> Jumper; from 1 to 3; insulated; blue	 <b>Item No.: 2000-433</b> Jumper; from 1 to 3; insulated; light gray
 <b>Item No.: 2000-433/000-005</b> Jumper; from 1 to 3; insulated; red	 <b>Item No.: 2000-434</b> Jumper; from 1 to 4; insulated; light gray	 <b>Item No.: 2000-435</b> Jumper; from 1 to 5; insulated; light gray	 <b>Item No.: 2000-436</b> Jumper; from 1 to 6; insulated; light gray
 <b>Item No.: 2000-437</b> Jumper; from 1 to 7; insulated; light gray	 <b>Item No.: 2000-438</b> Jumper; from 1 to 8; insulated; light gray	 <b>Item No.: 2000-439</b> Jumper; from 1 to 9; insulated; light gray	 <b>Item No.: 2000-405/011-000</b> Star point jumper; 3-way; insulated; light gray
 <b>Item No.: 210-103</b> Wire commoning chain; insulated; black	 <b>Item No.: 210-123</b> Wire commoning chain; insulated; blue		

1.2.5 Marking

1.2.5.1 Group marker carrier

 <b>Item No.: 2009-191</b> Group marker carrier; gray
--

1.2.5.2 Marker

 <b>Item No.: 793-3501</b> WMB marking card; as card; plain; snap-on type; white	 <b>Item No.: 2009-113/000-006</b> WMB-Inline; for Smart Printer; 2300 pieces on roll; plain; snap-on type; blue	 <b>Item No.: 2009-113/000-007</b> WMB-Inline; for Smart Printer; 2300 pieces on roll; plain; snap-on type; gray	 <b>Item No.: 2009-113/000-023</b> WMB-Inline; for Smart Printer; 2300 pieces on roll; plain; snap-on type; green
 <b>Item No.: 2009-113/000-017</b> WMB-Inline; for Smart Printer; 2300 pieces on roll; plain; snap-on type; light green	 <b>Item No.: 2009-113/000-012</b> WMB-Inline; for Smart Printer; 2300 pieces on roll; plain; snap-on type; orange	 <b>Item No.: 2009-113/000-005</b> WMB-Inline; for Smart Printer; 2300 pieces on roll; plain; snap-on type; red	 <b>Item No.: 2009-113/000-024</b> WMB-Inline; for Smart Printer; 2300 pieces on roll; plain; snap-on type; violet
 <b>Item No.: 2009-113</b> WMB-Inline; for Smart Printer; 2300 pieces on roll; plain; snap-on type; white	 <b>Item No.: 2009-113/000-002</b> WMB-Inline; for Smart Printer; 2300 pieces on roll; plain; snap-on type; yellow		

### 1.2.5.3 Marking strip



**Item No.: 2009-110**

Marking strips; for Smart Printer; on reel; not stretchable; plain; snap-on type; white

### 1.2.6 Protective warning marker

#### 1.2.6.1 Cover



**Item No.: 2000-115**

Protective warning marker; for 5 terminal blocks; with high-voltage symbol, black; yellow

### 1.2.7 Push-in type wire jumper

#### 1.2.7.1 Jumper



**Item No.: 2009-404**

Push-in type wire jumper; 0.75 mm<sup>2</sup>; insulated; 110 mm long; gray



**Item No.: 2009-406**

Push-in type wire jumper; 0.75 mm<sup>2</sup>; insulated; 250 mm long; gray



**Item No.: 2009-402**

Push-in type wire jumper; 0.75 mm<sup>2</sup>; insulated; 60 mm long; gray

### 1.2.8 Test and measurement

#### 1.2.8.1 Testing accessories



**Item No.: 2009-174**

Test plug adapter; for 4 mm Ø test plugs; for testing TOPJOB®S rail-mounted terminal blocks; gray



**Item No.: 210-136**

Test plug; 2 mm Ø; with 500 mm cable; red



**Item No.: 2009-182**

Testing tap; for max. 2.5 mm<sup>2</sup>; tool-free connection for individual test wires 0.08 - 2.5 mm; gray

### 1.2.9 Tool

#### 1.2.9.1 Operating tool



**Item No.: 210-719**

Operating tool; Blade: 2.5 x 0.4 mm; with a partially insulated shaft



**Item No.: 210-648**

Operating tool; Blade: 2.5 x 0.4 mm; with a partially insulated shaft; angled; short



**Item No.: 210-647**

Operating tool; Blade: 2.5 x 0.4 mm; with a partially insulated shaft; multicoloured

## Installation Notes

### Installation

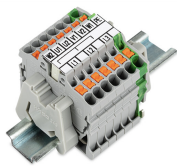

### Conductor termination



Insert solid conductors via push-in termination.



Insert ferruled conductors via push-in termination.



Insert fine-stranded conductors via operating tool.

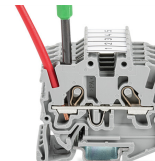

Remove all conductors via operating tool.

### Commoning

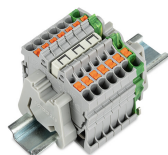

Insert a delta jumper and push down until it hits the backstop (example shows terminal blocks with push-buttons).

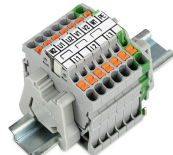

Marking strip (Item No. 2009-110) inserted in the marking slot with jumper symbols of the inserted jumper (delta jumper) (example shows terminal blocks with push-buttons)

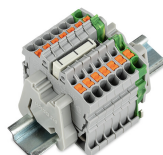

Insert a star point jumper and push down until it hits the backstop (example shows terminal blocks with push-buttons).

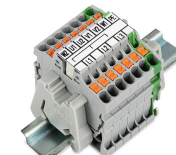

Marking strip (Item No. 2009-110) inserted in the marking slot with jumper symbols of the inserted jumper (2000-405/011-000 Delta Jumper) (example shows terminal blocks with push-buttons)

### Testing



Testing with a 2 mm Ø 210-136 Test Plug (max. 42 V).

### Marking



Snapping a marking strip into the marker slot.



Snapping a marking strip (Item No. 2009-110) into a marker slot.