

Data Sheet | Item Number: 250-709

Double-deck PCB terminal block; push-button; 1.5 mm²; Pin spacing 5 mm; 18-pole;
Push-in CAGE CLAMP®; agate gray

<https://www.wago.com/250-709>



Color: ■ agate gray

Similar to illustration

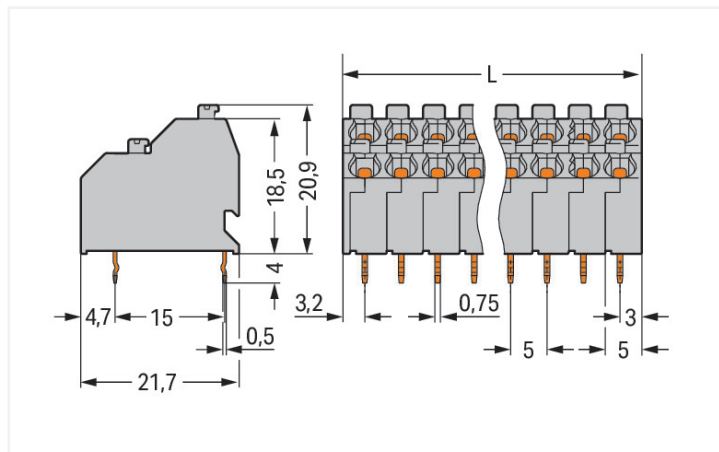

Dimensions in mm

$L = ((\text{Polzahl} / 2) \times \text{Rastermaß}) + 1,2 \text{ mm}$

PCB terminal block, 250 Series, with 5 mm pin spacing

Our PCB terminal block (item number 250-709) is designed for seamless electrical installations. It is ideal for custom installations with different mounting types. Our PCB terminal block is rated for 400 V and is designed to handle a rated current of up to 10 A. Conductors should only be connected to this PCB terminal block if their strip length is 9 mm. This product incorporates one conductor terminal and utilizes Push-in CAGE CLAMP®. Our Push-in CAGE CLAMP® is a universal, maintenance-free connection solution for all conductor types, offering a key advantage: both solid and fine-stranded conductors with ferrules can be directly inserted without the need for tools or any preparation, such as crimping the ferrule. The dimensions are 46.2 x 24.9 x 21.7 mm (width x height x depth). This PCB terminal block is suitable for conductor cross sections ranging from 0.5 mm² to 1.5 mm². Up to eighteen potentials / eighteen poles can be connected to this terminal strip using eighteen clamping points on two levels. The agate gray housing is made of polyamide (PA66) for insulation, the clamping spring is made of chrome-nickel spring steel (CrNi), and the contacts are made of electrolytic copper (ECu). Tin is used for coating the contact surfaces. A push-button is used to operate this PCB terminal block. THT is used to solder the PCB terminal block. The conductor is designed to be inserted into the board at a 45° angle. The solder pins, which are 0.5 x 0.75 mm in cross-section and 4 mm long, are laid out over the entire terminal strip (in-line). There are one solder pin per potential.

Notes

Variants:

Other pole numbers

Other colors

Direct marking

Other versions (or variants) can be requested from WAGO Sales or configured at <https://configurator.wago.com/>.

Electrical data

| Ratings per | IEC/EN 60664-1 | | |
|---------------------------------|----------------|-------|-------|
| Overvoltage category | III | III | II |
| Pollution degree | 3 | 2 | 2 |
| Nominal voltage | 320 V | 400 V | 630 V |
| Rated impulse withstand voltage | 4 kV | 4 kV | 4 kV |
| Rated current | 10 A | 10 A | 10 A |

| Approvals per | UL 1059 | | |
|---------------|---------|---|-------|
| Use group | B | C | D |
| Rated voltage | 300 V | - | 300 V |
| Rated current | 10 A | - | 10 A |

| Approvals per | CSA | | |
|---------------|-------|---|-------|
| Use group | B | C | D |
| Rated voltage | 300 V | - | 300 V |
| Rated current | 10 A | - | 10 A |

Connection data

| | |
|----------------------------|----|
| Clamping units | 18 |
| Total number of potentials | 18 |
| Number of connection types | 1 |
| Number of levels | 2 |

Connection 1

| | |
|---|---|
| Connection technology | Push-in CAGE CLAMP® |
| Actuation type | Push-button |
| Solid conductor | 0.5 ... 1.5 mm ² / 20 ... 16 AWG |
| Fine-stranded conductor | 0.75 ... 1.5 mm ² |
| Fine-stranded conductor; with insulated ferrule | 0.5 ... 1 mm ² |
| Fine-stranded conductor; with uninsulated ferrule | 0.5 ... 1 mm ² |
| Note (conductor cross-section) | Fine-stranded conductor 0.75 ... 1.5 mm ² (I max. 4 A) Fine-stranded conductor 0.5 mm ² (I max. 2 A) |
| Strip length | 9 mm / 0.35 inches |
| Conductor connection direction to PCB | 45 ° |
| Pole number | 18 |

Physical data

| | |
|--------------------------------------|-----------------------------------|
| Pin spacing | 5 mm / 0.197 inches |
| Width | 46.2 mm / 1.819 inches |
| Height | 24.9 mm / 0.98 inches |
| Height from the surface | 20.9 mm / 0.823 inches |
| Depth | 21.7 mm / 0.854 inches |
| Solder pin length | 4 mm |
| Solder pin dimensions | 0.5 x 0.75 mm |
| Drilled hole diameter with tolerance | 1.2 ^(-0.1 ... +0.1) mm |

PCB contact

| | |
|-------------------------------------|--|
| PCB contact | THT |
| Solder pin arrangement | over the entire terminal strip (in-line) |
| Number of solder pins per potential | 1 |

Material data

| | |
|------------------------------------|--|
| Note (material data) | Information on material specifications can be found here |
| Color | agate gray |
| Material group | I |
| Insulation material (main housing) | Polyamide (PA66) |
| Flammability class per UL94 | V0 |
| Clamping spring material | Chrome-nickel spring steel (CrNi) |
| Contact material | Electrolytic copper (E _{cu}) |
| Contact Plating | Tin |
| Fire load | 0.683 MJ |
| Weight | 17.3 g |

Environmental requirements

| | |
|-------------------------|-----------------|
| Limit temperature range | -60 ... +105 °C |
|-------------------------|-----------------|

Commercial data

| | |
|-----------------------|--------------------------------|
| Product Group | 4 (Printed Circuit Connectors) |
| PU (SPU) | 60 (15) pcs |
| Packaging type | Box |
| Country of origin | CH |
| GTIN | 4044918304528 |
| Customs tariff number | 85369010000 |

Product Classification

| | |
|-------------|----------------------|
| UNSPSC | 39121409 |
| eCl@ss 10.0 | 27-44-04-01 |
| eCl@ss 9.0 | 27-44-04-01 |
| ETIM 9.0 | EC002643 |
| ETIM 8.0 | EC002643 |
| ECCN | NO US CLASSIFICATION |

Environmental Product Compliance

| | |
|------------------------|-------------------------|
| RoHS Compliance Status | Compliant, No Exemption |
|------------------------|-------------------------|

Approvals / Certificates

General approvals



| Approval | Standard | Certificate Name |
|---------------------------------------|--------------|------------------|
| CCA DEKRA Certification B.V. | EN 60947 | NTR NL 7833/2 |
| CCA DEKRA Certification B.V. | EN 60998 | NTR NL-7705/1 |
| CSA DEKRA Certification B.V. | C22.2 | 1132097 |
| DEKRA DEKRA Certification B.V. | EN 60947-7-4 | 71-141963 |
| KEMA/KEUR DEKRA Certification B.V. | EN 60947 | 2160584.18 |
| KEMA/KEUR DEKRA Certification B.V. | EN 60998 | 71-124629 |
| UL UL International Germany GmbH | UL 1059 | E45172 |

Declarations of conformity and manufacturer's declarations

| Approval | Standard | Certificate Name |
|--|----------|------------------|
| EU-Declaration of Conformity WAGO GmbH & Co. KG | - | - |
| UK-Declaration of Conformity WAGO GmbH & Co. KG | - | - |

Approvals for marine applications



| Approval | Standard | Certificate Name |
|---|----------|------------------|
| ABS American Bureau of Ship- ping | - | 24-0095975-PDA |
| DNV DNV GL SE | - | TAE000016Z |

Downloads

Environmental Product Compliance

| Compliance Search | |
|---|-------------------|
| Environmental Product Compliance 250-709 | ↓ |

Documentation

| Additional Information | | | |
|------------------------|------------|-------------------|-------------------|
| Technical Section | 03.04.2019 | pdf 2027.26 KB | ↓ |

CAD/CAE-Data

| CAD data | |
|----------------------|-------------------|
| 2D/3D Models 250-709 | ↓ |

| CAE data | |
|----------------------|-------------------|
| ZUKEN Portal 250-709 | ↓ |

PCB Design

| | |
|--|-------------------|
| Symbol and Footprint via SamacSys 250-709 | ↓ |
| Symbol and Footprint via Ultra Librarian 250-709 | ↓ |

1 Compatible Products

1.1 Optional Accessories

1.1.1 Ferrule

1.1.1.1 Ferrule



Item No.: 216-241

Ferrule; Sleeve for 0.5 mm² / 20 AWG; insulated; electro-tin plated; electrolytic copper; gastight crimped; acc. to DIN 46228, Part 4/09.90; white

Item No.: 216-141

Ferrule; Sleeve for 0.5 mm² / 20 AWG; un-insulated; electro-tin plated; electrolytic copper; gastight crimped; acc. to DIN 46228, Part 1/08.92

Item No.: 216-242

Ferrule; Sleeve for 0.75 mm² / 18 AWG; insulated; electro-tin plated; electrolytic copper; gastight crimped; acc. to DIN 46228, Part 4/09.90; gray

Item No.: 216-262

Ferrule; Sleeve for 0.75 mm² / 18 AWG; insulated; electro-tin plated; electrolytic copper; gastight crimped; acc. to DIN 46228, Part 4/09.90; gray



Item No.: 216-142

Ferrule; Sleeve for 0.75 mm² / 18 AWG; uninsulated; electro-tin plated; electrolytic copper; gastight crimped; acc. to DIN 46228, Part 1/08.92

Item No.: 216-243

Ferrule; Sleeve for 1 mm² / AWG 18; insulated; electro-tin plated; electrolytic copper; gastight crimped; acc. to DIN 46228, Part 4/09.90; red

Item No.: 216-263

Ferrule; Sleeve for 1 mm² / AWG 18; insulated; electro-tin plated; electrolytic copper; gastight crimped; acc. to DIN 46228, Part 4/09.90; red

Item No.: 216-143

Ferrule; Sleeve for 1 mm² / AWG 18; uninsulated; electro-tin plated; electrolytic copper; gastight crimped; acc. to DIN 46228, Part 1/08.92

1.1.2 Marking

1.1.2.1 Marking strip



Item No.: 210-332/500-202

Marking strips; as a DIN A4 sheet; MARKED; 1-16 (160x); Height of marker strip: 3 mm; Strip length 182 mm; Horizontal marking; Self-adhesive; white

Item No.: 210-332/500-205

Marking strips; as a DIN A4 sheet; MARKED; 1-32 (80x); Height of marker strip: 3 mm; Strip length 182 mm; Horizontal marking; Self-adhesive; white

Item No.: 210-332/500-204

Marking strips; as a DIN A4 sheet; MARKED; 17-32 (160x); Height of marker strip: 3 mm; Strip length 182 mm; Horizontal marking; Self-adhesive; white

Item No.: 210-332/500-206

Marking strips; as a DIN A4 sheet; MARKED; 33-48 (160x); Height of marker strip: 3 mm; Strip length 182 mm; Horizontal marking; Self-adhesive; white

1.1.3 Test and measurement

1.1.3.1 Testing accessories



Item No.: 210-136

Test plug; 2 mm Ø; with 500 mm cable; red

1.1.4 Tool

1.1.4.1 Operating tool



Item No.: 210-719

Operating tool; Blade: 2.5 x 0.4 mm; with a partially insulated shaft

Item No.: 210-647

Operating tool; Blade: 2.5 x 0.4 mm; with a partially insulated shaft; multicoloured

Installation Notes

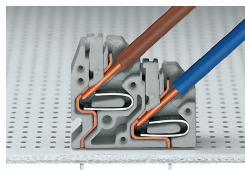

Space-saving wiring – push-in termination of solid conductors.

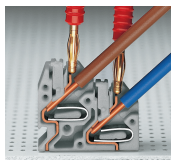

Testing with 2 mm Ø test plug – touch contact.

Conductor termination



Inserting solid conductors via push-in termination.
Inserting fine-stranded conductors via push-buttons, 250 Series – 3.5 mm pin spacing.

Conductor termination

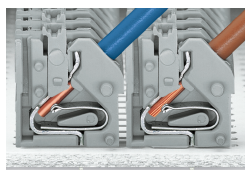

Space-saving wiring, 250 Series – 5 mm pin spacing.

Testing

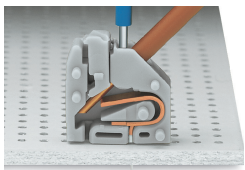

Testing with 11 mm Ø test pin, on the conductor, 250 Series – 2.5 ... 3.5 mm pin spacing.

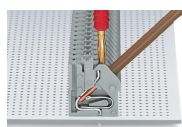

Testing with 2 mm Ø test plug, touch contact, 250 Series – 5 mm pin spacing.

Marking

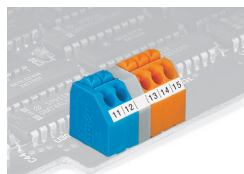
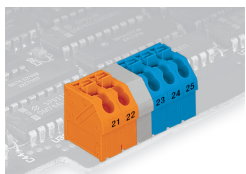

Labeling via self-adhesive strips or direct marking. Mixed-color terminal strips (with or without spacer) are available upon request.

Labeling via self-adhesive strips or direct marking. Mixed-color terminal strips (with or without spacer) are available upon request.