

Product: KLUDI LOGOFLEX-hose DN 15

Ref.: 6105505-00

Product description

LOGOFLEX-hose DN 15
 plastic coated
 with metal-effect
 with conical nuts
 G 1/2 x G 1/2 x 1250 mm

Finishes:
 05 chrome

Product picture

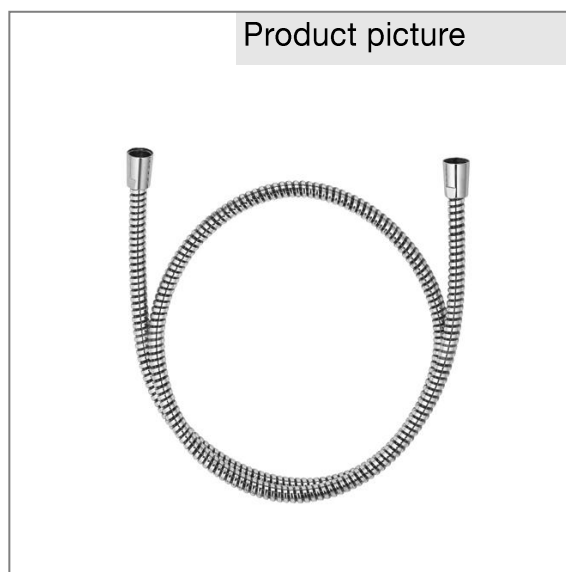

Advertisement

shower hose, manufacturer KLUDI GmbH & Co KG KLUDI LOGOFLEX hose item no. 6105505-00, DN 15, plastic coated with metal-effect, with conical nuts chrome plated 1/2 x 1/2 inch x 1250 mm, PN 5,

Dimensional drawing

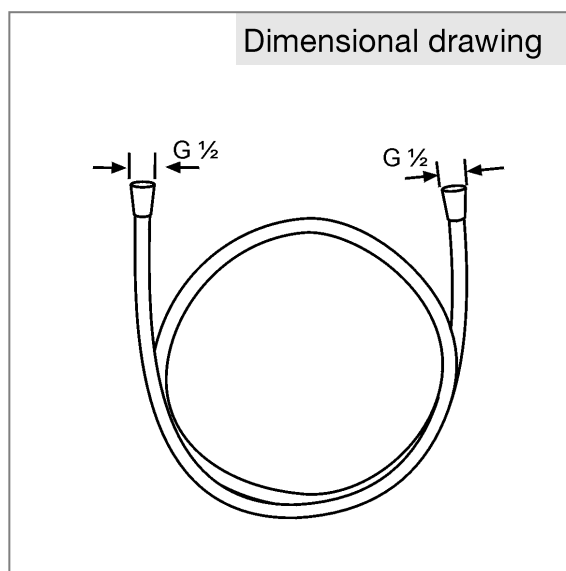

Flow rate diagram

