







CL.1 Deck-mounted basin spout without pop-up waste - Brushed Dark Platinum

CL.1

13 714 705 Product version from 7/1/2021 to 6/15/2021



- 160mm projection
- fixed spout
- rectangular spray pattern with 40 individual jets
- height of mixer 108 mm
- height up to aerator 94 mm
- hole diameter 35 mm
- 2x screw-in M 10 x 1 pressure hose, leak-tested
- 1/2" connection
- max. flow 4 l/min
- lead-free
- This product can help a building meet the requirements of Green Building Rating Systems, e.g. LEED®, BREEAM®, DGNB
- WRAS

	Brushed Dark Platinum	13 714 705-99
	Chrome	13 714 705-00
	Brushed Platinum	13 714 705-06
	Dark Chrome	13 714 705-19
	Brushed Light Gold (PVD)	13 714 705-27
	Brushed Champagne (22kt Gold)	13 714 705-46
	Champagne (22kt Gold)	13 714 705-47

13 714 705 Product version from 7/1/2021 to 6/15/2021

mm [inches]

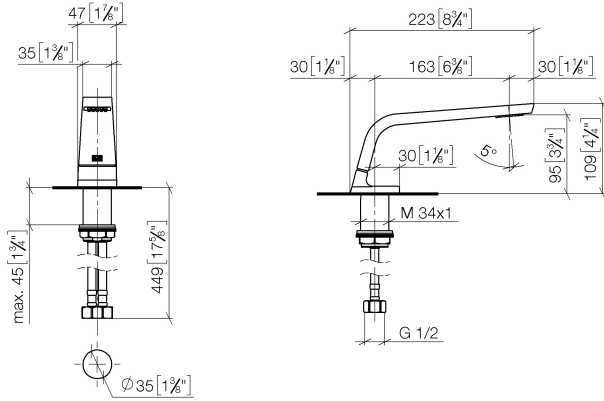

Flow rate chart

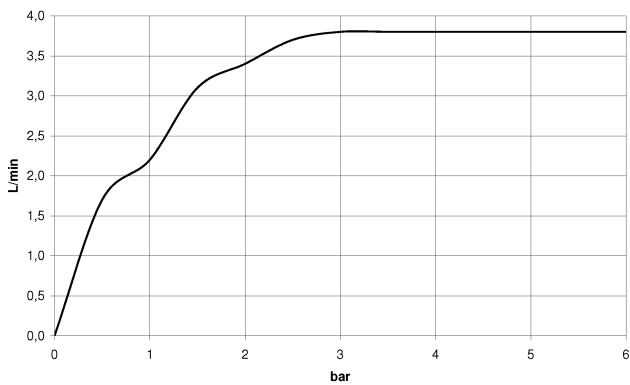

Codes & Standards

ASME A112.18.1	cUPC	DIN 4109	EPA WaterSense
Executive Order no. 1007	ISO 3822	NSF372	NSF61
Scottish Water Byelaws	UK Water Supply Regulations	Ü-Zeichen	WaterSense





CL.1 Deck-mounted basin spout without pop-up waste - Brushed Dark Platinum

CL.1

13 714 705 Product version from 7/1/2021 to 6/15/2021

Certificates and sustainability

GDV_0400	IAPMO_8834	IAPMO_N-4	LGA_28	IAPMO_4976
WRAS_1512	IAPMO_6	EPD-DOR-20230287 -IBA1-EN Environmental.prod uct-declarat		

13 714 705 Product version from 7/1/2021 to 6/15/2021

Parts for other finishes can be found here: [Chrome](#)

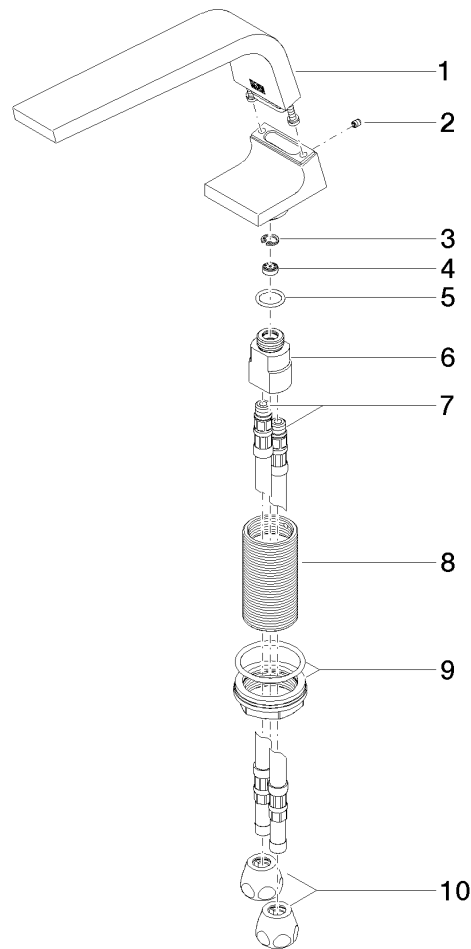

Spare parts list

No.	Item Number	Name	Quantity used	Delivery time
	6 09 11 10 055 10 90	Connection 19 x 35 x 26 mm -	1.00	14
	3 09 16 01 016 90	Ring Retaining ring Ø 10 x 1 mm -	1.00	14
	8 09 30 01 208 90	Connection Ø 34 x 65 mm -	1.00	14
	4 09 23 01 034 90	Flow limiter white 4 l/min. -	1.00	14
	9 04 23 10 044 06 90	Mounting with seals M34 x 1 -	1.00	14
	10 90 23 30 040 00-99	Union piece - Brushed Dark Platinum	2.00	40
	1 90 11 70 002 00-99	Spout 45 x 100 x 213 mm - Brushed Dark Platinum	1.00	40
	5 09 14 10 130 90	O-Ring EPDM 70 14,0 x 2,00 mm -	1.00	14
	7 04 30 04 016 00 90	High pressure hose M10x1 x 420 mm -	2.00	-
	Spare part can no longer be ordered, please order the replacement item			
	0430041040090	High pressure hose M10x1 x 3/8" x 420 mm -		
	2 09 31 11 044 90	Mounting Threaded pin with hexagon socket with cup point M4 x 5 mm -	1.00	14