

PRESTATIEVERKLARING

DoP 0337

voor fischer FAZ II Plus dynamic (Bevestigingen in gescheurd of ongescheurd beton)

NL

1. Unieke identificatiecode van het producttype: **DoP 0337**
2. Beoogde(e) gebruik(en): **Achteraf geïnstalleerde bevestigingsmiddelen voor gebruik in beton onder cyclische vermoeiingsbelasting, zie bijlage, met name de bijlagen B1- B4.**
3. Fabrikant: **fischerwerke GmbH & Co. KG, Klaus-Fischer-Str. 1, 72178 Waldachtal, Duitsland**
4. Gemachtigde: **-**
5. Het systeem of de systemen voor de beoordeling en verificatie van de prestatiebestendigheid: **1**
6. Europees beoordelingsdocument: **EAD 330250-00-0601, Edition 06/2021**
Europese technische beoordeling: **ETA-20/0897; 2023-05-22**
Technische beoordelingsinstantie: **DIBt- Deutsches Institut für Bautechnik**
Aangemelde instantie(s): **2873 TU Darmstadt**

7. Aangegeven prestatie(s):

EAD 330250-00-0601; Table 2.1

Mechanische weerstand en stabiliteit (BWR 1)

Kenmerkende weerstand tegen spanningsbelasting (statische en quasi-statische belasting) Methode A:

Weerstand tegen staalbreuk: Bijlage C1

Weerstand tegen uittrekken: Bijlage C1

Weerstand tegen betonnen kegelbreuk: Bijlage C1

Robuustheid Bijlage C1

Minimale rand- en hartafstand: Bijlages C5, C6

Randafstand om spleetbreuk onder belasting te voorkomen: Bijlage C1

Kenmerkende weerstand tegen schuifbelasting (statische en quasi-statische belasting), methode A:

Weerstand tegen staalbreuk (afschuifbelasting): Bijlage C2

Weerstand tegen uitbreken (pryout): Bijlage C2

Verplaatsingen:

Verplaatsingen onder statische en quasi-statische belasting: Bijlage C9

Kenmerkende weerstand en verplaatsingen voor de seismische prestatiecategorieën C1 en C2:

Trekkraachtweerstand, categorie C1: Bijlage C7

Trekkraachtweerstand, verplaatsingen categorie C2: Bijlages C8, C9

Weerstand afschuifbelasting, categorie C1: Bijlage C7

Weerstand afschuifbelasting, verplaatsingen categorie C2: Bijlages C8, C9

Factor ringvormige opening: Bijlages C7, C8

Veiligheid in geval van brand (BWR 2)

Reactie op brand: Klasse (A1)

Weerstand tegen vuur:

Weerstand bij brand, staalbreuk (trekbelasting): Bijlage C3

Weerstand bij brand, uittrekken, (trekbelasting): Bijlage C3

Weerstand bij brand, staalbreuk (afschuifbelasting): Bijlages C3, C4

Duurzaamheid:

Duurzaamheid: Bijlages A3, B1

EAD 330250-00-0601; Table 2.5

Beoordelingsmethode C: Lineaire functie

Mechanische weerstand en stabiliteit (BWR 1)

Karakteristieke staalmoeidingsweerstand onder trekbelasting: Bijlages C10, C11

Karakteristieke betonkegel, uittrek-, splijt- en uitblaasweerstand onder trekbelasting: Bijlages C10, C11

Karakteristieke uittrek- of gecombineerde uittrek-/betonconusmoeidingsweerstand onder trekbelasting: Bijlages C10, C11

Karakteristieke staalmoeidingsweerstand onder afschuifbelasting: Bijlages C10, C11

Karakteristieke weerstand van beton tegen vermoeidheid onder schuifbelasting: Bijlages C10, C11

Karakteristieke weerstand tegen uitbreukmoeidheid van beton onder schuifbelasting: Bijlages C10, C11

Karakteristieke staalmoeidingsweerstand onder spanning en afschuiving: Bijlages C10, C11

Belastingsoverdrachtsfactor voor trek- en schuifbelasting: Bijlages C10, C11



8. Geëigende technische documentatie en/of specifieke technische documentatie: -

De prestaties van het hierboven omschreven product zijn conform de aangegeven prestaties. Deze prestatieverklaring wordt in overeenstemming met Verordening (EU) nr. 305/2011 onder de exclusieve verantwoordelijkheid van de hierboven vermelde fabrikant verstrekt.

Ondertekend voor en namens de fabrikant door:

Dr. Oliver Geibig, Managing Director Business Units & Engineering
Tumlingen, 2023-06-05

Jürgen Grün, Managing Director Chemistry & Quality

Deze DoP is opgesteld in meerdere talen. In het geval van geschillen over de interpretatie zal de Engelse tekst altijd prevaleren.

Het aanhangsel bevat vrijwillige en aanvullende informatie in het Engels die de (taal-neutraal gespecificeerde) wettelijke vereisten overschrijdt.

Specific Part

1 Technical description of the product

The fischer Bolt Anchor FAZ II Plus dynamic is an anchor made of galvanised steel (FAZ II Plus dynamic) or stainless steel (FAZ II Plus dynamic R) which is placed into a drilled hole and anchored by torque-controlled expansion.

The fastener consists of an fischer Bolt Anchor FAZ II Plus with cone bolt, expansion clip, washer and hexagon nut and a Dynamic set with filling conical washer, spherical washer and lock nut.

The product description is given in Annex A.

2 Specification of the intended use in accordance with the applicable European Assessment Document

The performances given in Section 3 are only valid if the fastener is used in compliance with the specifications and conditions given in Annex B.

The verifications and assessment methods on which this European Technical Assessment is based lead to the assumption of a working life of the fastener of at least 50 years. The indications given on the working life cannot be interpreted as a guarantee given by the producer, but are to be regarded only as a means for choosing the right products in relation to the expected economically reasonable working life of the works.

3 Performance of the product and references to the methods used for its assessment

3.1 Mechanical resistance and stability (BWR 1)

Essential characteristic (static, quasi-static loading and seismic)	Performance
Characteristic resistance to tension load (static and quasi-static loading)	See Annexes C 1, C 5, C 6
Characteristic resistance to shear load (static and quasi-static loading)	See Annex C 2
Displacements (static and quasi-static loading)	See Annex C 9
Characteristic resistance and displacements for seismic performance categories C1 and C2	See Annexes C 7 to C 9

Essential characteristic (fatigue loading, Linearized function - Assessment method C)	Performance
Characteristic fatigue resistance under cyclic tension loading	See Annexes C 10 and C 11
Characteristic steel fatigue resistance $\Delta N_{Rk,s,0,n}$ ($n = 1$ to $n = \infty$)	
Characteristic concrete cone, pull-out, splitting and blow out fatigue resistance $\Delta N_{Rk,c,0,n}$ $\Delta N_{Rk,sp,0,n}$ $\Delta N_{Rk,cb,0,n}$ ($n = 1$ to $n = \infty$)	
Characteristic pull- out fatigue resistance $\Delta N_{Rk,p,0,n}$ ($n = 1$ to $n = \infty$)	

Essential characteristic (fatigue loading, Linearized function - Assessment method C)	Performance
Characteristic fatigue resistance under cyclic shear loading	
Characteristic steel fatigue resistance $\Delta V_{Rk,s,0,n}$ ($n = 1$ to $n = \infty$)	See Annexes C 10 and C 11
Characteristic concrete edge fatigue resistance $V_{Rk,c,0,n}$ ($n = 1$ to $n = \infty$)	
Characteristic concrete pry out fatigue resistance $\Delta V_{Rk,cp,0,n}$ ($n = 1$ to $n = \infty$)	
Characteristic fatigue resistance under cyclic combined tension and shear loading	
Characteristic steel fatigue resistance a_s ($n = 1$ to $n = \infty$)	See Annexes C 10 and C 11
Load transfer factor for cyclic tension and shear loading	
Load transfer factor ψ_{FN}, ψ_{FV}	See Annexes C 10 and C 11

3.2 Safety in case of fire (BWR 2)

Essential characteristic	Performance
Reaction to fire	Class A1
Resistance to fire	See Annex C 3 and C 4

3.3 Aspects of durability

Essential characteristic	Performance
Durability	See Annex B 1

4 Assessment and verification of constancy of performance (AVCP) system applied, with reference to its legal base

In accordance with European Assessment Document No. 330250-00-0601, the applicable European legal act is: [96/582/EC].

The system to be applied is: 1

Cone bolt manufactured by cold - forming:

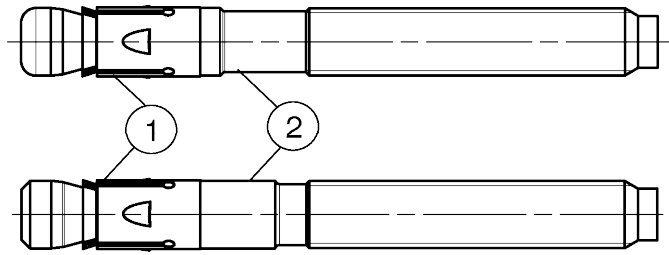

Cone bolt manufactured by turning:

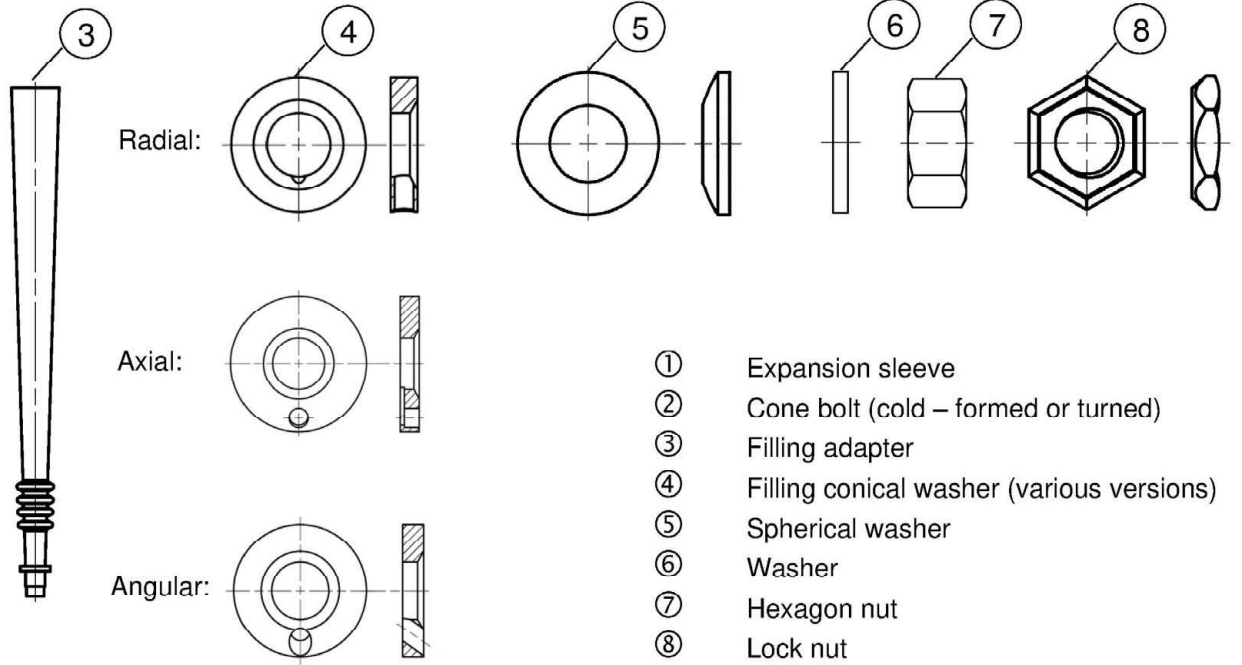

- ① Expansion sleeve
- ② Cone bolt (cold – formed or turned)
- ③ Filling adapter
- ④ Filling conical washer (various versions)
- ⑤ Spherical washer
- ⑥ Washer
- ⑦ Hexagon nut
- ⑧ Lock nut

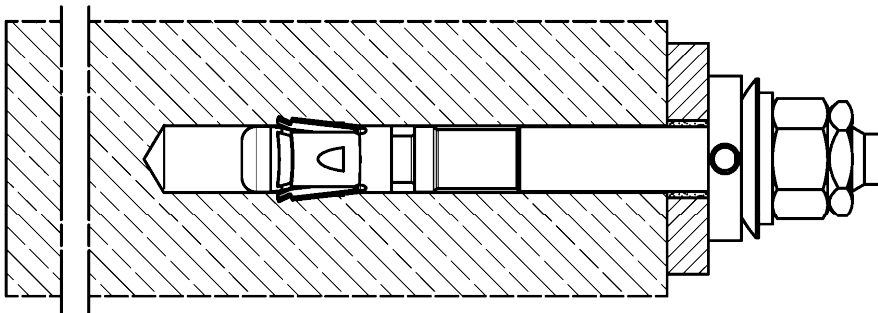

(Fig. not to scale)

fischer Bolt Anchor FAZ II Plus dynamic

Product description
Installed condition

Annex A 1

Appendix 3 / 20

Product marking and letter-code:

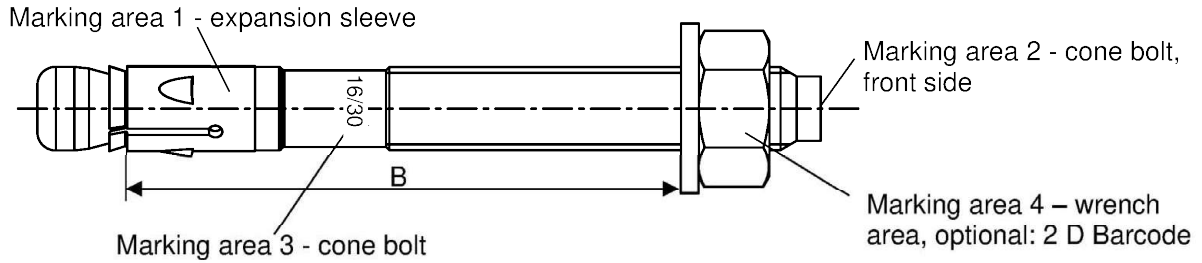

Product marking, example:

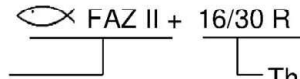

Brand | type of fastener
placed at marking area 1 or 3

Thread size / max. thickness of the fixture (t_{fix})
identification R placed at marking area 1 or 3

FAZ II Plus dynamic: carbon steel, galvanised
FAZ II Plus dynamic R: stainless steel

Table A2.1: Letter - code at marking area 2:

Marking	(a)	(b)	(c)	(d)	(A)	(B)	(C)	(D)	(E)	(F)	(G)	(H)	(I)	(K)	
Max. $t_{fix,ges}$ [mm]	5	10	15	20	5	10	15	20	25	30	35	40	45	50	
$B \geq$ [mm]	M16	70	75	80	85	90	95	100	105	110	115	120	125	130	135
	M20					105	110	115	120	125	130	135	140	145	150
	M24					130	135	140	145	150	155	160	165	170	175

Marking	(L)	(M)	(N)	(O)	(P)	(R)	(S)	(T)	(U)	(V)	(W)	(X)	(Y)	(Z)	
Max. $t_{fix,ges}$ [mm]	60	70	80	90	100	120	140	160	180	200	250	300	350	400	
$B \geq$ [mm]	M16	145	155	165	175	185	205	225	245	265	285	335	385	435	485
	M20	160	170	180	190	200	220	240	260	280	300	350	400	450	500
	M24	185	195	205	215	225	245	265	285	305	325	375	425	475	525

Calculation existing h_{ef} for installed fasteners:

existing $h_{ef} = B_{(according\ to\ table\ A2.1)} - existing\ t_{fix,ges}$

$t_{fix,ges}$ see Annex B2

(Fig. not to scale)

fischer Bolt Anchor FAZ II Plus dynamic

Product description
Product marking and letter code

Annex A 2

Appendix 4 / 20

Table A3.1: Materials FAZ II Plus dynamic

Part	Designation	Material	
		FAZ II Plus dynamic	FAZ II Plus dynamic R
	Steel grade	Steel	Stainless steel R
		Zinc plated $\geq 5 \mu\text{m}$, ISO 4042:2018	Acc. to EN 10088:2014 Corrosion resistance class CRC III acc. to EN 1993-1-4:2006+A1:2015
1	Expansion sleeve	Cold strip, EN 10139:2016 or stainless steel EN 10088:2014	Stainless steel EN 10088:2014
2	Cone bolt	Cold form steel or free cutting steel	
3	Filling adapter	Plastic	
4	Filling conical washer	Cold form steel or free cutting steel	Stainless steel EN 10088:2014
5	Spherical washer		
6	Washer	Cold strip, EN 10139:2016	Stainless steel EN 10088:2014; ISO 3506-2:2018; property class – min. 70
7	Hexagon nut	Steel, property class min. 8, EN ISO 898-2:2012	
8	Lock nut	Cold strip, EN 10139:2016	Stainless steel EN 10088:2014
	Injection cartridge	Mortar, hardener, filler (compressive strength $\geq 50 \text{ N/mm}^2$)	



fischer Bolt Anchor FAZ II Plus dynamic

Product description
Materials**Annex A 3**

Appendix 5 / 20

Specifications of intended use

Fastenings subject to:

Size	FAZ II Plus dynamic, FAZ II Plus dynamic R		
	M16	M20	M24
Hammer drilling with standard drill bit 			
Hammer drilling with hollow drill bit with automatic cleaning 		✓	
Static and quasi-static loading in cracked and uncracked concrete		✓	
Seismic actions category C1 and C2 – not in combination with fatigue loading		✓	
Fire exposure – not in combination with fatigue loading		✓	
Fatigue load in cracked and uncracked concrete – not in combination with seismic- or fire exposure		✓	

Base materials:

- Compacted reinforced and unreinforced normal weight concrete without fibres (cracked and uncracked) according to EN 206:2013+A2:2021
- Strength classes C20/25 to C50/60 according to EN 206:2013+A2:2021

Use conditions (Environmental conditions):

- Structures subject to dry internal conditions (FAZ II Plus dynamic, FAZ II Plus dynamic R)
- For all other conditions according to EN 1993-1-4:2006 + A1:2015 corresponding to corrosion resistance class CRC III: for FAZ II Plus dynamic R

Design:

- Fastenings are to be designed under the responsibility of an engineer experienced in fastenings and concrete work
- Verifiable calculation notes and drawings are to be prepared taking account of the loads to be anchored. The position of the fastener is indicated on the design drawings (e.g. position of the fastener relative to reinforcement or to supports, etc.)
- Design of fastenings according to EN 1992-4:2018 and EOTA Technical Report TR 061: 2020-08 "Design method for fasteners in concrete under fatigue cyclic loading"
- Fastenings in stand-off installation according to EN 1992-4:2018, 6.2.2.3 are not covered by this European Technical Assessment
- Fatigue design cannot be done in combination with seismic- or fire exposure

fischer Bolt Anchor FAZ II Plus dynamic

Intended use
Specifications

Annex B 1

Appendix 6 / 20

Table B2.1: Installation parameters

Size	FAZ II Plus dynamic, FAZ II Plus dynamic R		
	M16	M20	M24
Nominal drill hole diameter $d_0 =$	16	20	24
Maximum bit diameter with hammer or hollow drilling $d_{cut,max}$ [mm]	16,50	20,55	24,55
Effective embedment depth $h_{ef} \geq$	65 - 160	100 - 180	125
Length from h_{ef} to end of cone bolt L	17,5	20,0	23,5
Overall fastener embedment depth in the concrete $h_{nom} \geq$	$h_{ef} + L$		
Depth of drill hole to deepest point $h_1^{1)} \geq$	$h_{nom} + 5$	$h_{nom} + 10$	
Diameter of clearance hole in the fixture $d_f \leq$ [mm]	18	22	26
Required setting torque $T_{inst} =$ [Nm]	110	200	270
Minimum thickness of the fixture $t_{fix,min} \geq$	15	20	24
Thickness of the fixture $t_{fix,ges} =$ [mm]	$t_{fix} + 11$	$t_{fix} + 13$	$t_{fix} + 17$

¹⁾ For the application without drill hole cleaning: $h_{1,nc} = h_1 + 15$ mm

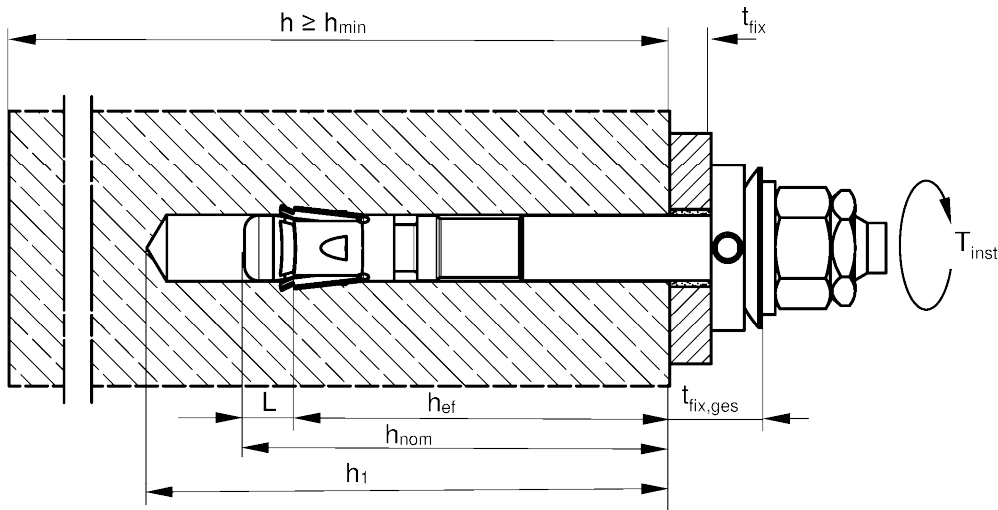

- h_{ef} = Effective embedment depth
- t_{fix} = Thickness of the fixture
- $t_{fix,ges}$ = Thickness of the fixture and the filling set
- h_1 = Depth of drill hole to deepest point
- $h_{1,nc}$ = Depth of drill hole to deepest point without cleaning
- h = Thickness of the concrete member
- h_{min} = Minimum thickness of concrete member
- h_{nom} = Overall fastener embedment depth in the concrete
- T_{inst} = Required setting torque
- L = Length from h_{ef} to end of cone bolt

(Fig. not to scale)

fischer Bolt Anchor FAZ II Plus dynamic

Intended use
Installation parameters

Annex B 2







Appendix 7 / 20

Installation instructions:

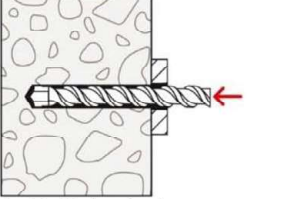
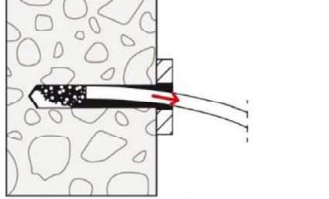
- Fastener installation carried out by appropriately qualified personnel according to the design drawings and under the supervision of the person responsible for technical matters on the site
- Use of the fastener only as supplied by the manufacturer without exchanging the components of the fastener
- Hammer- or hollow drilling according to Annex B 2
- Drill hole created perpendicular +/- 5° to concrete surface, positioning without damaging the reinforcement
- In case of aborted hole: new drilling at a minimum distance twice the depth of the aborted drill hole or smaller distance if the aborted drill hole is filled with high strength mortar and if under shear or oblique tension load it is not in the direction of load application

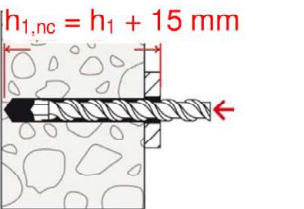
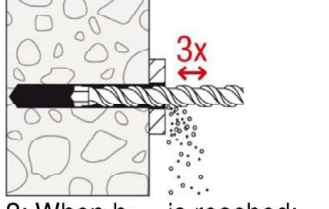
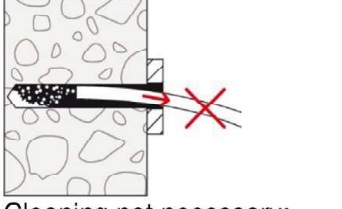
Installation instructions: Drilling and cleaning the hole

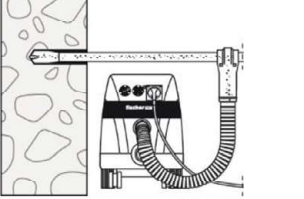
Types of drills and cleaning

<p>Hammer drill (e.g. fischer Quattric II) with cleaning</p>		 <p>1: Drill the hole</p>	 <p>2: Clean the hole</p>	<p>Continue with step 5</p>
<p>Hammer drill (e.g. fischer Quattric II) without cleaning</p>		 <p>1: Drill the hole</p> <p>$h_{1,nc} = h_1 + 15 \text{ mm}$</p>	 <p>2: When $h_{1,nc}$ is reached: Pull out drill 3 x</p>	 <p>Cleaning not necessary; Continue with step 5</p>
<p>Hollow drill (e.g. fischer FHD)</p>		 <p>1: Drill the hole with automatic cleaning (e.g. fischer FVC)</p>	 <p>Cleaning obsolete</p>	<p>Continue with step 5</p>

fischer Bolt Anchor FAZ II Plus dynamic

Intended use
Installation instructions

Annex B 3

Appendix 8 / 20

Installation instructions: Installation of the fastener

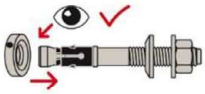

5: Check the position of the conical washer

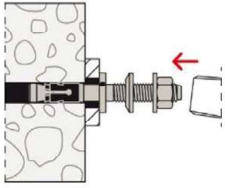

6: Set the fastener. E.g. with fischer FA-ST II setting tool:

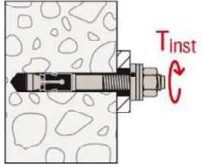
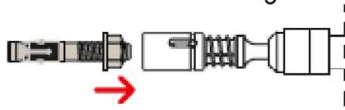

7: Apply T_{inst}

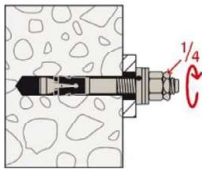

8: Tighten lock nut manually, then use wrench to give another quarter turn

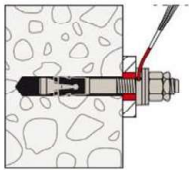

9: The gap between anchor and fixture (annular gap) must be filled with mortar (compressive strength $\geq 50 \text{ N/mm}^2$ e.g. fischer FIS HB, FIS V Plus, FIS EM Plus or FIS SB) via the fillable conical washer.

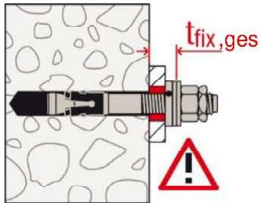

10: Correctly installed fastener

fischer Bolt Anchor FAZ II Plus dynamic

Intended use
Installation instructions

Annex B 4

Appendix 9 / 20

Table C1.1: Characteristic values of **tension** resistance under static and quasi-static action

Size		FAZ II Plus dynamic, FAZ II Plus dynamic R				
		M16	M20	M24		
Steel failure						
Characteristic resistance	FAZ II Plus dynamic	$N_{Rk,s}$ [kN]	78,7	108,4	180,0	
	FAZ II Plus dynamic R		83,0	127,6	187,0	
Partial factor for steel failure	FAZ II Plus dynamic	$\gamma_{Ms}^{1)}$ [-]	1,40	1,40	1,50	
	FAZ II Plus dynamic R		1,45			
Pullout failure						
Effective embedment depth for calculation	h_{ef} [mm]		65 - 160	100 - 180	125	
Characteristic resistance in cracked concrete C20/25	$N_{Rk,p}$ (C20/25) [kN]		27,0	34,4	48,1	
Characteristic resistance in uncracked concrete C20/25			38,6	49,2	68,8	
Increasing factor ψ_c for cracked or uncracked concrete	[-]	$N_{Rk,p} = \psi_c \cdot N_{Rk,p}$ (C20/25)	C25/30	1,12		
		C30/37	1,22			
		C35/45	1,32			
		C40/50	1,41			
		C45/55	1,50			
		C50/60	1,58			
Installation sensitivity factor	γ_{inst} [-]		1,0			
Concrete cone and splitting failure						
Factor for uncracked concrete	$k_{ucr,N}$ [-]		11,0 ²⁾			
Factor for cracked concrete	$k_{cr,N}$ [-]		7,7 ²⁾			
Characteristic spacing	$s_{cr,N}$ [mm]		$3 \cdot h_{ef}$			
Characteristic edge distance	$c_{cr,N}$ [mm]		$1,5 \cdot h_{ef}$			
Characteristic spacing for splitting failure	$s_{cr,sp}$ [mm]		$2 \cdot c_{cr,sp}$			
Characteristic edge distance for splitting failure	$c_{cr,sp}$ [mm]		$2 \cdot h_{ef}$	$2,4 \cdot h_{ef}$	$h \geq 140$	$2,2 \cdot h_{ef}$
		$h \geq 160$				
Characteristic resistance to splitting	$N^0_{Rk,sp}$ [kN]		$\min \{N^0_{Rk,c}; N_{Rk,p}\}^{3)}$			

1) In absence of other national regulations

2) Based on concrete strength as cylinder strength

3) $N^0_{Rk,c}$ according to EN 1992-4:2018

4) No performance assessed

fischer Bolt Anchor FAZ II Plus dynamic

Performances

Characteristic values of tension resistance under static and quasi-static action

Annex C 1

Appendix 10 / 20

Table C2.1: Characteristic values of shear resistance under static and quasi-static action

Size	FAZ II Plus dynamic, FAZ II Plus dynamic R			
	M16	M20	M24	
Steel failure without lever arm				
Characteristic resistance	FAZ II Plus dynamic with filling	69,8	85,6	128,3
	FAZ II Plus dynamic with filling R	73,6	117,9	158,1
Partial factor for steel failure	$\gamma_{Ms}^{1)}$	1,25		
Factor for ductility	k_7	1,0		
Steel failure with lever arm and Concrete pryout failure				
Effective embedment depth for calculation	h_{ef} [mm]	85 - 160	100 - 180	125
Characteristic bending resistance	FAZ II Plus dynamic	266	422	864
	FAZ II Plus dynamic R	256	519	898
Factor for pryout failure	k_8 [-]	3,2		
Effective embedment depth for calculation	h_{ef} [mm]	65 - < 85	..2)	
Characteristic bending resistance	FAZ II Plus dynamic	251		
	FAZ II Plus dynamic R	256		
Factor for pryout failure	k_8 [-]	3,2		
Partial factor for steel failure	$\gamma_{Ms}^{1)}$	1,25		
Factor for ductility	k_7	1,0		
Concrete edge failure				
Effective embedment depth for calculation	l_f [mm]	h_{ef}		
Outside diameter of a fastener	d_{nom}	16	20	24

1) In absence of other national regulations

2) No performance assessed

fischer Bolt Anchor FAZ II Plus dynamic

Performances

Characteristic values of shear resistance under static and quasi-static action

Annex C 2

Appendix 11 / 20

Table C3.1: Characteristic values of **tension** resistance under **fire exposure** – not in combination with fatigue loading

Size			FAZ II Plus dynamic, FAZ II Plus dynamic R			
			M16		M20	M24
$h_{ef} \geq$ [mm]			65 - < 85	85 - 160	100 - 180	125
Characteristic resistance steel failure	FAZ II Plus dynamic	$N_{Rk,s,fi}$	R30	9,4	14,7	21,1
			R60	7,7	12,0	17,3
			R90	6,0	9,4	13,5
			R120	5,2	8,1	11,6
	FAZ II Plus dynamic R	$N_{Rk,s,fi}$	R30	21,8	34,3	49,4
			R60	13,2	20,7	29,3
			R90	10,5	18,3	26,4
			R120 [kN]	8,6	17,3	25,0
Characteristic resistance Concrete cone failure	$N_{Rk,c,fi}$	R30 - R90	$7,7 \cdot h_{ef}^{1,5} \cdot (20)^{0,5} \cdot h_{ef} / 200 / 1000$			
		R120	$7,7 \cdot h_{ef}^{1,5} \cdot (20)^{0,5} \cdot h_{ef} / 200 / 1000 \cdot 0,8$			
Characteristic resistance pullout failure	$N_{Rk,p,fi}$	R30	4,5	6,8	8,6	12,0
		R60				
		R90	3,6	5,4	6,9	9,6
		R120				

Table C3.2: Characteristic values of **shear** resistance under **fire exposure** – not in combination with fatigue loading

FAZ II Plus dynamic			R30		R60		
			$V_{Rk,s,fi,30}$ [kN]	$M^0_{Rk,s,fi,30}$ [Nm]	$V_{Rk,s,fi,60}$ [kN]	$M^0_{Rk,s,fi,60}$ [Nm]	
M16	$h_{ef} \geq$	65	[mm]	11,7	19,9	9,1	16,3
M20		100		18,2	39,0	14,2	31,8
M24		125		26,3	67,3	20,5	55,0
FAZ II Plus dynamic			R90		R120		
			$V_{Rk,s,fi,90}$ [kN]	$M^0_{Rk,s,fi,90}$ [Nm]	$V_{Rk,s,fi,120}$ [kN]	$M^0_{Rk,s,fi,120}$ [Nm]	
M16	$h_{ef} \geq$	65	[mm]	6,6	12,6	5,3	11,0
M20		100		10,3	24,6	8,3	21,4
M24		125		14,8	42,6	11,9	37,0

Concrete pryout failure according to EN 1992-4:2018

fischer Bolt Anchor FAZ II Plus dynamic

Performances

Characteristic values of resistance under fire exposure

Annex C 3

Appendix 12 / 20

Table C4.1: Characteristic values of **shear** resistance under **fire exposure** – not in combination with fatigue loading

FAZ II Plus dynamic R		R30		R60				
		$V_{Rk,s,fi,30}$ [kN]	$M^0_{Rk,s,fi,30}$ [Nm]	$V_{Rk,s,fi,60}$ [kN]	$M^0_{Rk,s,fi,60}$ [Nm]			
M16	$h_{ef} \geq$ <table style="display: inline-table; vertical-align: middle;"><tr><td style="border: 1px solid black; padding: 2px;">65</td></tr><tr><td style="border: 1px solid black; padding: 2px;">100</td></tr><tr><td style="border: 1px solid black; padding: 2px;">125</td></tr></table> [mm]	65	100	125	21,8	46,2	13,2	27,9
65								
100								
125								
M20	34,3	90,9	20,7	54,9				
M24	49,4	157,2	29,3	93,1				

FAZ II Plus dynamic R		R90		R120				
		$V_{Rk,s,fi,90}$ [kN]	$M^0_{Rk,s,fi,90}$ [Nm]	$V_{Rk,s,fi,120}$ [kN]	$M^0_{Rk,s,fi,120}$ [Nm]			
M16	$h_{ef} \geq$ <table style="display: inline-table; vertical-align: middle;"><tr><td style="border: 1px solid black; padding: 2px;">65</td></tr><tr><td style="border: 1px solid black; padding: 2px;">100</td></tr><tr><td style="border: 1px solid black; padding: 2px;">125</td></tr></table> [mm]	65	100	125	10,5	22,1	8,6	18,3
65								
100								
125								
M20	18,3	48,6	17,3	45,9				
M24	26,4	84,0	25,0	79,4				

Concrete pryout failure according to EN 1992-4:2018

Table C4.2: Minimum spacings and minimum edge distances of fasteners under **fire exposure** for **tension** and **shear** load

Size	FAZ II Plus dynamic, FAZ II Plus dynamic R		
	M16	M20	M24
Spacing s_{min}	Annex C5		
Edge distance c_{min} [mm]	$c_{min} = 2 \cdot h_{ef}$, for fire exposure from more than one side $c_{min} \geq 300$ mm		

fischer Bolt Anchor FAZ II Plus dynamic

Performances
Characteristic values of resistance under fire exposure

Annex C 4

Appendix 13 / 20

Table C5.1: Minimum thickness of concrete members, minimum spacing and minimum edge distance

Size	FAZ II Plus dynamic, FAZ II Plus dynamic R			
	M16	M20	M24	
Minimum edge distance				
Uncracked concrete	65	95	135	
Cracked concrete c_{min}		85	100	
Corresponding spacing s	[mm] according to Annex C 6			
Minimum thickness of concrete member h_{min}	140	160	200	
Thickness of concrete member $h \geq$	max. $\{h_{min}; 1,5 \cdot h_{ef}; h_1^{(1)} + 30\}$			
Minimum spacing				
Uncracked concrete	65	95	100	
Cracked concrete s_{min}				
Corresponding edge distance c	[mm] according to Annex C 6			
Minimum thickness of concrete member h_{min}	140	160	200	
Thickness of concrete member $h \geq$	max. $\{h_{min}; 1,5 \cdot h_{ef}; h_1^{(1)} + 30\}$			
Minimum splitting area				
Uncracked concrete	$A_{sp,req}$ [$\cdot 1000$ mm ²]	67	100	117,5
Cracked concrete		50	77	87,5

¹⁾ Or $h_{1,nc}$ if borehole cleaning is omitted

Table C5.2: Calculated values for minimum spacing and minimum edge distances **for cracked concrete with one edge** (c_2 and $c_3 \geq 1,5 c_1$) in the cleaned borehole

Type of anchor / size	FAZ II Plus dynamic, FAZ II Plus dynamic R			
	M16	M20	M24	
Effective anchorage depth $h_{ef} \geq$ [mm]	65	85	100	125
Minimum thickness of concrete member $h \geq$ [mm]	140	180	160	200
Minimum spacing s_{min} [mm]	65		95	100
	for $c \geq$ [mm]	100	75	130
Minimum edge distance c_{min} [mm]	65		85	100
	for $s \geq$ [mm]	165	85	230

fischer Bolt Anchor FAZ II Plus dynamic

Performances

Minimum thickness of member, minimum spacings and edge distances

Annex C 5

Appendix 14 / 20

Determination of $A_{sp,ef}$ for each existing free edge

Splitting failure applied for minimum edge distance and spacing in depending on h_{ef}

Definition Index:

cal = calculatory

e.g.: $s_{x,y}$

x = load direction

y = number anchor plate

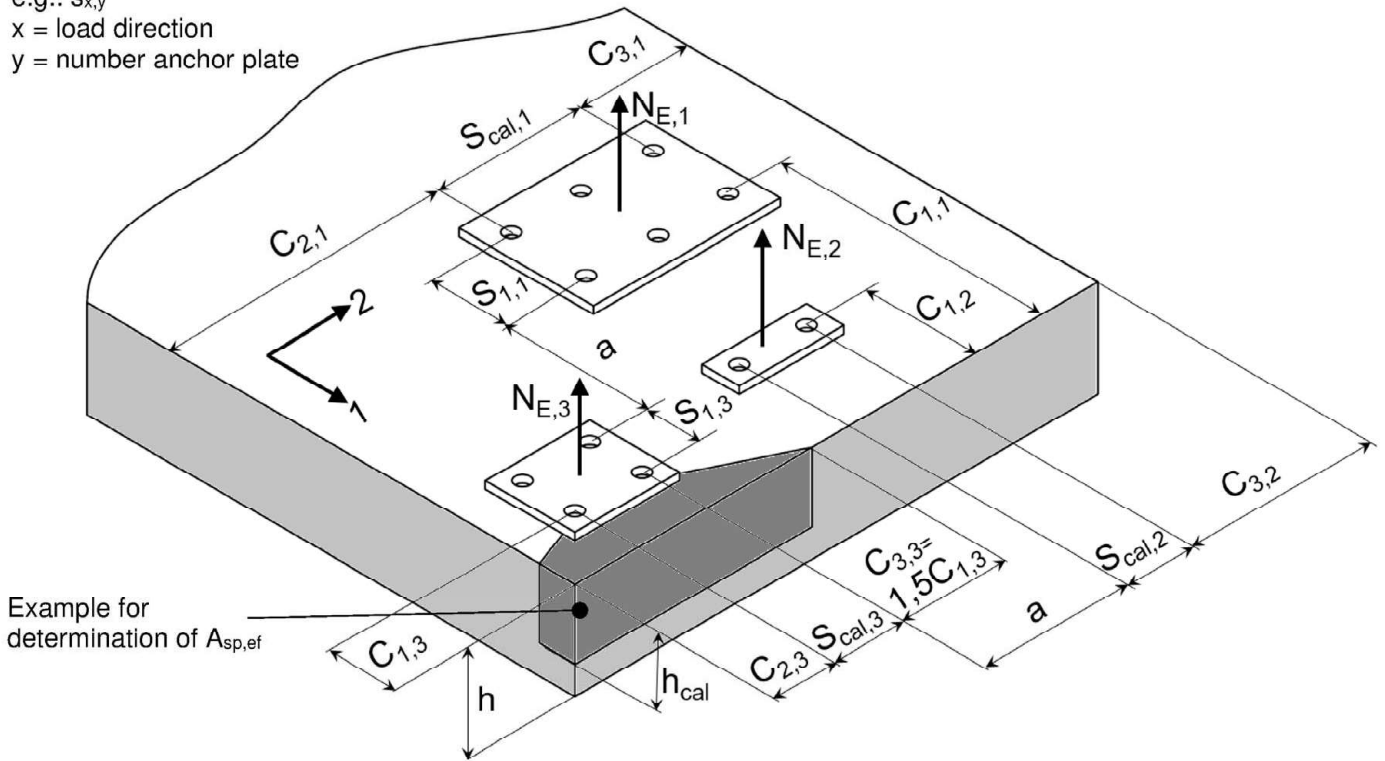

Example for different anchor plates: For considering all free edges the direction 1 and 2 must be swapped.

General formulation for each free edge: $A_{sp,ef} = (C_2 + S_{cal} + C_3) \cdot h_{cal} \geq (n/2) \cdot A_{sp,req}$

with:

Edge distance c_1 : $c_{min} \leq c_1$

Edge distance c_2 : $c_{min} \leq c_2 \leq 1,5 \cdot c_1$

Edge distance c_3 : $c_{min} \leq c_3 \leq 1,5 \cdot c_1$

Calculation spacing, distance between outer anchors s_{cal} : $s_{min} \leq s_{cal} \leq 3,0 \cdot c_1$

Distance between group of anchors a : For $a \geq 3,0 \cdot c_1$ no influence between the anchor groups is taken into account.

Number of anchors n of an anchor plate as well close and parallel to the edge

Effective member thickness h_{cal} : $h_{min} \leq h$; $h_{cal} \leq h$; $h_{cal} \leq (h_{ef} + 1,5 \cdot c_1)$

c_1 , c_2 , c_3 , h and s_{cal} have to be set in way that the requirement is fulfilled

For the calculation of minimum spacing and minimum edge distance of fasteners in combination with different embedment depths and thicknesses of concrete members the following equation shall be fulfilled:

$$A_{sp,req} < A_{sp,ef}$$

$A_{sp,req}$ = required splitting area (according to Annex C 5)

$A_{sp,ef}$ = effective splitting area

(Fig. not to scale)

fischer Bolt Anchor FAZ II Plus dynamic

Performances

Minimum thickness of member, minimum spacings and edge distances

Annex C 6

Appendix 15 / 20

Table C7.1: Characteristic values of **tension and shear** resistance under **seismic action category C1** – not in combination with fatigue loading

Size	FAZ II Plus dynamic, FAZ II Plus dynamic R			
	M16	M20	M24	
Effective embedment depth h_{ef} [mm]	85 - 160	100 - 180	125	
With filling of the annular gap α_{gap} [-]	1,0			
Steel failure $N_{Rk,s,C1} = N_{Rk,s}$; $\gamma_{Ms,C1} = \gamma_{Ms}$ (see Annex C1)				
Pullout failure				
Characteristic resistance in cracked concrete C1 $N_{Rk,p,C1}$ [kN]	27,0	34,4	48,1	
Installation sensitivity factor γ_{inst} [-]	1,0			
Concrete cone failure and splitting failure $N_{Rk,c,C1} = N^0_{Rk,c}$; $N_{Rk,sp,C1} = N^0_{Rk,sp}$ (see Annex C1)				
Steel failure without lever arm				
Characteristic resistance C1	FAZ II Plus dynamic			
	h_{ef} [mm]	85 - 160	100 - 180	125
	With filling $V_{Rk,s,C1}$ [kN]	59,3	85,6	102,6
	FAZ II Plus dynamic R			
	h_{ef} [mm]	85 - 160	100 - 180	125
	With filling $V_{Rk,s,C1}$ [kN]	62,6	94,3	126,5
Partial factor for steel failure $\gamma_{Ms,C1}^{1)}$ [-]	1,25			

¹⁾ In absence of other national regulations

fischer Bolt Anchor FAZ II Plus dynamic

Performances

Characteristic values of tension and shear resistance under seismic action category C1

Annex C 7

Appendix 16 / 20

Table C8.1: Characteristic values of tension and shear resistance under seismic action category C2 – not in combination with fatigue loading

Size	FAZ II Plus dynamic, FAZ II Plus dynamic R			
	M16	M20	M24	
With filling of the annular gap α_{gap} [-]	1,0			
Steel failure $N_{Rk,s,C2} = N_{Rk,s}$; $\gamma_{Ms,C2} = \gamma_{Ms}$ (see Annex C1)				
Pullout failure				
Characteristic resistance in cracked concrete C2	h_{ef} [mm]	85 - 160	100 - 180	125
	$N_{Rk,p,C2}$ [kN]	21,5	30,7	39,6
	h_{ef} [mm]	65 - <85	_2)	
	$N_{Rk,p,C2}$ [kN]	16,4		
Installation sensitivity factor γ_{inst} [-]	1,0			
Concrete cone failure and splitting failure $N_{Rk,c,C2} = N_{Rk,c}^0$; $N_{Rk,sp,C2} = N_{Rk,sp}^0$ (see Annex C1)				
Steel failure without lever arm				
Characteristic resistance C2	FAZ II Plus dynamic			
	h_{ef} [mm]	85 - 160	100 - 180	125
	With filling $V_{Rk,s,C2}$ [kN]	52,4	68,5	102,6
	h_{ef} [mm]	65 - <85	_2)	
	With filling $V_{Rk,s,C2}$ [kN]	52,4		
	FAZ II Plus dynamic R			
	h_{ef} [mm]	85 - 160	100 - 180	125
	With filling $V_{Rk,s,C2}$ [kN]	55,2	104,9	126,5
	h_{ef} [mm]	65 - <85	_2)	
	With filling $V_{Rk,s,C2}$ [kN]	55,2		
Partial factor for steel $\gamma_{Ms,C2}^{1)}$ [-]	1,25			

¹⁾ In absence of other national regulations

²⁾ No performance assessed

fischer Bolt Anchor FAZ II Plus dynamic

Performances

Characteristic values of tension and shear resistance under seismic action C2

Annex C 8

Appendix 17 / 20

Table C9.1: Displacements under static and quasi static **tension** loads

Size	FAZ II Plus dynamic, FAZ II Plus dynamic R		
	M16	M20	M24
Displacement – factor for tensile load¹⁾			
δ_{N0} - factor in cracked concrete	0,08	0,07	0,05
$\delta_{N\infty}$ - factor [mm/kN]	0,09		0,07
δ_{N0} - factor in uncracked concrete	0,06	0,05	0,04
$\delta_{N\infty}$ - factor	0,10	0,06	0,05

Table C9.2: Displacements under static and quasi static **shear** loads

Size	FAZ II Plus dynamic, FAZ II Plus dynamic R		
	M16	M20	M24
Displacement – factor for shear load²⁾			
FAZ II Plus dynamic			
δ_{V0} - factor	0,10	0,09	0,07
$\delta_{V\infty}$ - factor in cracked or uncracked concrete [mm/kN]	0,14	0,15	0,11
FAZ II Plus dynamic R			
δ_{V0} - factor	0,10	0,11	0,07
$\delta_{V\infty}$ - factor	0,15	0,17	0,11

¹⁾ Calculation of effective displacement:

$$\delta_{N0} = \delta_{N0} - \text{factor} \cdot N$$

$$\delta_{N\infty} = \delta_{N\infty} - \text{factor} \cdot N$$

N = Action tension loading

²⁾ Calculation of effective displacement:

$$\delta_{V0} = \delta_{V0} - \text{factor} \cdot V$$

$$\delta_{V\infty} = \delta_{V\infty} - \text{factor} \cdot V$$

V = Action shear loading

Table C9.3: Displacements under **tension** loads for **category C2** for all embedment depths

Size	FAZ II Plus dynamic, FAZ II Plus dynamic R		
	M16	M20	M24
DLS $\delta_{N,C2}$ (DLS) [mm]	4,4	5,6	4,8
ULS $\delta_{N,C2}$ (ULS)	12,3	14,4	15,2

¹⁾ No performance assessed

Table C9.4: Displacements under **shear** loads for **category C2** for all embedment depths

Size	FAZ II Plus dynamic, FAZ II Plus dynamic R		
	M16	M20	M24
DLS with filling $\delta_{V,C2}$ (DLS) [mm]	1,2	2,0	4,2
ULS with filling $\delta_{V,C2}$ (ULS)	3,1	4,4	7,4

¹⁾ No performance assessed

fischer Bolt Anchor FAZ II Plus dynamic

Performances

Displacements under tension and shear loads

Annex C 9

Appendix 18 / 20

Table C10.1: Essential characteristic values under tension and shear fatigue loads Design method I according to TR 061 – not in combination with seismic- or fire exposure

Required evidence

	Number of load cycles (n)			
	$n \leq 10^4$	$10^4 < n \leq 5 \cdot 10^6$	$5 \cdot 10^6 < n \leq 10^8$	$n > 10^8$

Tension load capacity¹⁾

$\Delta N_{Rk,s,0,n}$ FAZ II Plus dynamic [kN]	$N_{Rk,s}^{fat} \cdot 0,227$	$N_{Rk,s}^{fat} \cdot 10^{(-0,299-0,085 \cdot \log(n))}$	$N_{Rk,s}^{fat} \cdot 10^{(-0,544-0,048 \cdot \log(n))}$	$N_{Rk,s}^{fat} \cdot 0,11$
$\Delta N_{Rk,s,0,n}$ FAZ II Plus dynamic R	$N_{Rk,s}^{fat} \cdot 0,335$	$N_{Rk,s}^{fat} \cdot 10^{(0,427-0,226 \cdot \log(n))}$	$N_{Rk,s}^{fat} \cdot 10^{(-0,405-0,101 \cdot \log(n))}$	$N_{Rk,s}^{fat} \cdot 0,05$
$N_{Rk,s}^{fat} = N_{Rk,s}$ according to Annex C1				

Characteristic fatigue resistance for concrete cone and concrete splitting and pull-out

$\Delta N_{Rk,c,sp/p,0,n}$ FAZ II Plus dynamic; FAZ II Plus dynamic R [kN]	$N_{Rk,c,sp/p}^{fat} \cdot 0,68$	$N_{Rk,c,sp/p}^{fat} \cdot 10^{(0,055-0,055 \cdot \log(n))}$ $\geq N_{Rk,c,sp/p}^{fat} \cdot 0,5$	$N_{Rk,c,sp/p}^{fat} \cdot 0,5$	$N_{Rk,c,sp/p}^{fat} \cdot 0,5$
$N_{Rk,s}^{fat} = N_{Rk,s}$ according to Annex C1				

Shear load capacity

$\Delta V_{Rk,s,0,n}$ FAZ II Plus dynamic [kN]	$V_{Rk,s}^{fat} \cdot 0,26$	$V_{Rk,s}^{fat} \cdot 10^{(-0,15-0,108 \cdot \log(n))}$	$V_{Rk,s}^{fat} \cdot 10^{(-0,48-0,059 \cdot \log(n))}$	$V_{Rk,s}^{fat} \cdot 0,10$
$V_{Rk,s}^{fat} = 62,8 \text{ kN for M16; } V_{Rk,s}^{fat} = 82,9 \text{ kN for M20; } V_{Rk,s}^{fat} = 128,3 \text{ kN for M24}$				
$\Delta V_{Rk,s,0,n}$ FAZ II Plus dynamic R	$V_{Rk,s}^{fat} \cdot 0,26$	$V_{Rk,s}^{fat} \cdot 10^{(-0,242-0,084 \cdot \log(n))}$	$V_{Rk,s}^{fat} \cdot 10^{(-0,536-0,040 \cdot \log(n))}$	$V_{Rk,s}^{fat} \cdot 0,13$
$V_{Rk,s}^{fat} = 62,8 \text{ kN for M16; } V_{Rk,s}^{fat} = 98,0 \text{ kN for M20; } V_{Rk,s}^{fat} = 141,2 \text{ kN for M24}$				

Characteristic fatigue resistance for concrete edge and pryout failure

$\Delta V_{Rk,c,cp,0,n}$ FAZ II Plus dynamic; FAZ II Plus dynamic R [kN]	$V_{Rk,c,cp}^{fat} \cdot 0,58$	$V_{Rk,c,cp}^{fat} \cdot 10^{(0,08-0,08 \cdot \log(n))}$ $\geq V_{Rk,c,cp}^{fat} \cdot 0,5$	$V_{Rk,c,cp}^{fat} \cdot 0,5$	$V_{Rk,c,cp}^{fat} \cdot 0,5$
$V_{Rk,c,cp}^{fat} = V_{Rk,c,cp}$ according to EN 1992-4 with k_8 according to Annex C2				

Exponents and load-transfer factor

Exponent for combined load

$\alpha_s = \alpha_{sn}$ [-]	0,7
------------------------------	-----

Load-transfer factor

$\psi_{FN} = \psi_{Fv}$ [-]	0,5
-----------------------------	-----

Exponent for combined load, verification regarding failure modes other than steel failure

α_c [-]	1,5
----------------	-----

¹⁾ The annular gap filling can be omitted if there is a pure tension load

fischer Bolt Anchor FAZ II Plus dynamic

Performances

Essential characteristic values under tension and shear fatigue loads
Design method I according to TR 061

Annex C 10

Appendix 19 / 20

Table C11.1: Essential characteristic values under tension and shear fatigue loads Design method II according to TR 061 – not in combination with seismic- or fire exposure

Size		FAZ II Plus dynamic, FAZ II Plus dynamic R				
		M 16	M20	M24		
Tension load						
Effective embedment depth	h_{ef}	[mm]	65 - 160	100 - 180	125	
Steel failure						
Characteristic steel fatigue resistance	FAZ II Plus dynamic FAZ II Plus dynamic R	$\Delta N_{Rk,s,0,\infty}$	[kN]	8,7	11,9	19,8
				4,2	6,4	9,4
Concrete failure						
Characteristic concrete fatigue resistance		$\Delta N_{Rk,c,0,\infty}$ $\Delta N_{Rk,p,0,\infty}$ $\Delta N_{Rk,sp,0,\infty}$	[kN]	$0,5 \cdot N_{Rk,c}$		
				$0,5 \cdot N_{Rk,p}$		
				$0,5 \cdot N_{Rk,sp}$		
Shear load						
Shear load capacity, steel failure without lever arm						
Characteristic steel fatigue resistance	FAZ II Plus dynamic FAZ II Plus dynamic R	$\Delta V_{Rk,s,0,\infty}$	[kN]	6,3	8,3	12,8
				8,2	12,7	18,4
Concrete pryout failure						
Characteristic concrete fatigue resistance		$\Delta V_{Rk,cp,0,\infty}$	[kN]	$0,5 \cdot V_{Rk,cp}$		
Concrete edge failure						
Characteristic concrete fatigue resistance		$\Delta V_{Rk,c,0,\infty}$	[kN]	$0,5 \cdot V_{Rk,c}$		
Value of h_{ef} (=l _r) under shear load	h_{ef}	[mm]	65 - 160	100 - 180	125	
Effective outside diameter of the anchor	d_{nom}		16	20	24	
Exponents and load-transfer factor						
Exponent for combined load						
$\alpha_s = \alpha_{sn}$	[-]	0,7				
Load-transfer factor						
$\psi_{FN} = \psi_{Fv}$	[-]	0,5				
Exponent for combined load, verification regarding failure modes other than steel failure						
α_c	[-]	1,5				

fischer Bolt Anchor FAZ II Plus dynamic

Performances

Essential characteristic values under tension and shear fatigue loads
Design method II according to TR 061

Annex C 11

Appendix 20 / 20