

Wall elbow - Brushed Dark Platinum









SERIES SPECIFIC

28 450 980 Product version up to 7/6/2018



- 3/8" shower outlet
- rosette 60 x 60 mm
- 1/2" connection
- WRAS

Intrinsic protection against back flow.

	Brushed Dark Platinum	28 450 980-99
	Chrome	28 450 980-00
	Brushed Platinum	28 450 980-06
	Platinum	28 450 980-08
	Dark Chrome	28 450 980-19
	Light Gold (PVD)	28 450 980-26
	Brushed Light Gold (PVD)	28 450 980-27
	Brushed Durabrass (23kt Gold)	28 450 980-28
	Matte Black	28 450 980-33
	Brushed Gold (PVD)	28 450 980-37
	Brushed Dark Brass (PVD)	28 450 980-39
	Brushed Bronze (PVD)	28 450 980-42
	Brushed Dark Bronze (PVD)	28 450 980-43
	Brushed Champagne (22kt Gold)	28 450 980-46
	Champagne (22kt Gold)	28 450 980-47
	Brushed Chrome	28 450 980-93

Recommended miscellaneous



- Concealed wall elbow -** 35 085 970 90
- min. recess depth 90 mm
 - max. recess depth 163 mm

28 450 980 Product version up to 7/6/2018

mm [inches]

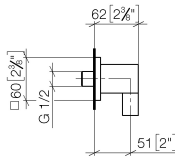

Flow rate chart

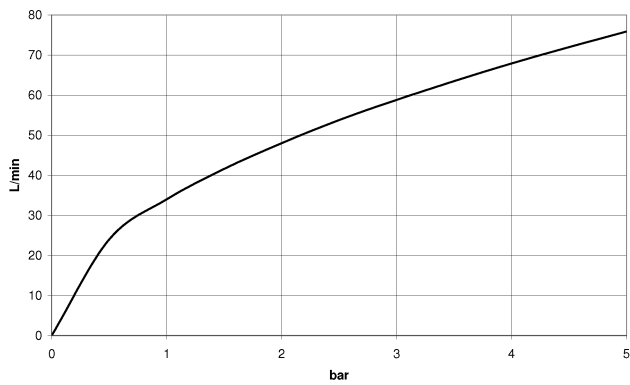

Codes & Standards

ASME A112.18.1

cUPC

EN 1717

Scottish Water
Byelaws

UK Water Supply
Regulations



Wall elbow - Brushed Dark Platinum

SERIES SPECIFIC

28 450 980 Product version up to 7/6/2018

Certificates and sustainability

Belgaqua_22_280_2 WRAS_2310

IAPMO_4976

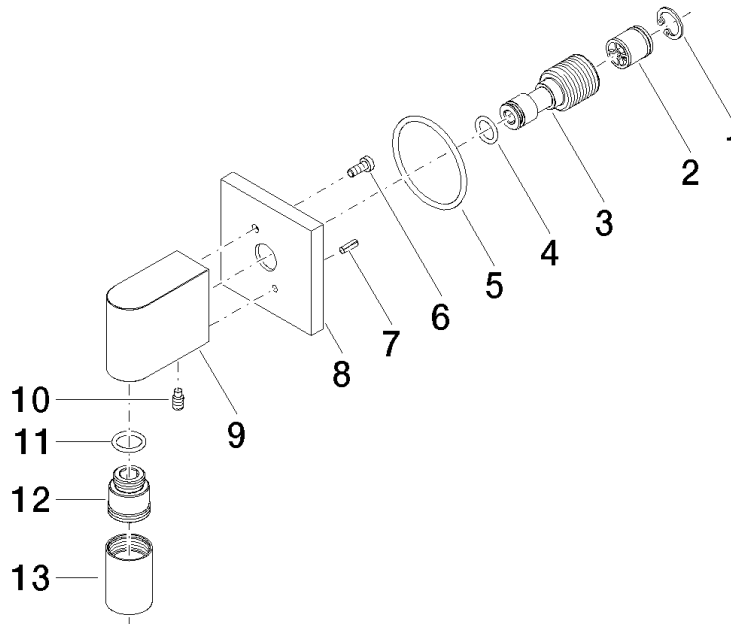

Spare parts list

No.	Item Number	Name	Quantity used	Delivery time
7	09 31 11 026 90	Grooved pin Ø 5 x12 mm -	1.00	14
13	90 21 02 069 00-99	Cover/sleeve M20 x 1 - Brushed Dark Platinum	1.00	40
5	09 14 10 142 90	O-Ring 47,3 x 1,78 mm -	1.00	14
8	09 27 82 006-99	Rosette for wall elbows 60 x 60 x 9 mm - Brushed Dark Platinum	1.00	40
10	09 31 11 005 90	Mounting Threaded pin with hexagon socket with pins M5 x 10 mm -	1.00	14
9	09 11 03 046-99	Wall elbow - Brushed Dark Platinum	1.00	40
3	09 24 03 116 20 90	Nipple Ø 21 x 50 mm -	1.00	14
6	09 30 30 054 90	Mounting Cylinder head screw with hexagon socket with low profile M4 x 10 mm -	1.00	14
4	09 14 10 008 90	O-Ring 10,0 x 2,0 mm -	1.00	14
2	90 23 01 141 00 90	Back-flow preventer -	1.00	14
12	09 24 03 107 20 90	Nipple Ø 20 x 21,5 mm -	1.00	14
11	90 14 10 077 00 90	O-Ring EPDM 70 12,0 x 2,0 mm -	1.00	14
1	09 16 01 014 90	Ring Retaining ring Ø 15 x 1 mm -	1.00	14