

Color: ■ light gray

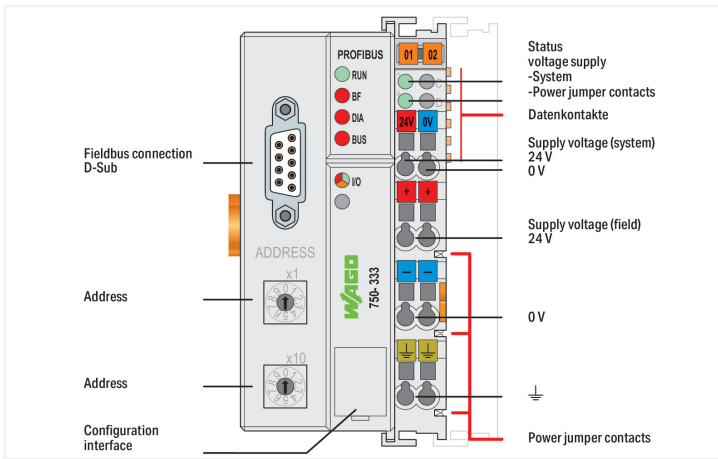

The 750-333 Fieldbus Coupler maps the peripheral data of all the WAGO I/O System's I/O modules on PROFIBUS DP. When initializing, the coupler determines the node's module structure and creates the process image of all inputs and outputs. Modules with a bit width smaller than eight are grouped in one byte for address space optimization. It is furthermore possible to deactivate I/O modules and to modify the image of the node according to the connected signals without having to modify the existing control application. The diagnostic concept is based on ID- and channel-related diagnostics according to EN 50170. This does away with the need for programming modules to evaluate manufacturer-specific diagnostic data.

Notes

Note **Note: Configuration files required (GSD)!**

Technical data

Communications	PROFIBUS
Number of fieldbus nodes on master (max.)	96
Number of I/O points	6000
Transmission rate	9.6 kBd ... 12 MBd
Bus segment length (max.)	1200 m
Transmission medium (communication/fieldbus)	Cu cable per EN 50170
Transmission time	typ. 1 ms (10 couplers; each 32 digital I/O and 12 Mbaud) max. 3.3 ms
Number of modules per node (max.)	63
Number of modules without a bus extension (max.)	63
Input and output process image (fieldbus) max.	244 bytes/244 bytes
Supply voltage (system)	24 VDC (-25 ... +30 %); via pluggable connector (CAGE CLAMP® connection)
Current consumption (5 V system supply)	200 mA
Total current (system supply)	1800 mA
Supply voltage (field)	24 VDC (-25 ... +30 %); via power jumper contacts
Input current (typ.) at nominal load (24 V)	500 mA
Power supply efficiency (typ.) at nominal load (24 V)	87 %
Isolation	500 VDC system/field
Number of outgoing power jumper contacts	3
Current carrying capacity (power jumper contacts)	10 A

Connection Data

Connection technology: communication/fieldbus	PROFIBUS: 1 x D-sub 9 socket
Connection technology: field supply	6 x CAGE CLAMP®
Connection technology: system supply	2 x CAGE CLAMP®
Connectable conductor materials	Copper
Connection type	System/field supply
Solid conductor	0.08 ... 2.5 mm ² / 28 ... 14 AWG
Fine-stranded conductor	0.08 ... 2.5 mm ² / 28 ... 14 AWG
Strip length	8 ... 9 mm / 0.31 ... 0.35 inches
Connection technology: device configuration	1 x Male connector; 4-pole

Physical data

Width	50.5 mm / 1.988 inches
Height	100 mm / 3.937 inches
Depth	71.1 mm / 2.799 inches
Depth from upper-edge of DIN-rail	63.9 mm / 2.516 inches

Mechanical data

Mounting type	DIN-35 rail
---------------	-------------

Material data

Color	light gray
Housing material	Polycarbonate; polyamide 6.6
Fire load	2.069 MJ
Weight	183.8 g
Conformity marking	CE

Environmental requirements

Ambient temperature (operation)	-20 ... +60 °C
Ambient temperature (storage)	-40 ... +85 °C
Protection type	IP20
Pollution degree	2 per IEC 61131-2
Operating altitude	0 ... 2000 m / 0 ... 6562 ft
Mounting position	Horizontal left, horizontal right, horizontal top, horizontal bottom, vertical top and vertical bottom
Relative humidity (without condensation)	95 %
Relative humidity (with condensation)	Short-term condensation per Class 3K6/IEC EN 60721-3-3 and E-DIN 40046-721-3, accounting for a temperature range of -20 to +60 °C (except for wind-driven precipitation, water and ice formation)
Vibration resistance	4g per IEC 60068-2-6
Shock resistance	15g per IEC 60068-2-27
EMC immunity to interference	per EN 61000-6-2, marine applications
EMC emission of interference	per EN 61000-6-4, marine applications
Exposure to pollutants	per IEC 60068-2-42 and IEC 60068-2-43
Permissible H ₂ S contaminant concentration at a relative humidity 75 %	10 ppm
Permissible SO ₂ contaminant concentration at a relative humidity 75 %	25 ppm

Commercial data

Product Group	15 (I/O System)
PU (SPU)	1 pcs
Packaging type	Box
Country of origin	DE
GTIN	4045454526887
Customs tariff number	85176200000

Product Classification

UNSPSC	32151705
eCl@ss 10.0	27-24-26-07
eCl@ss 9.0	27-24-26-07
ETIM 9.0	EC001603
ETIM 10.0	EC001603
ECCN	NO US CLASSIFICATION

Environmental Product Compliance

CAS-No.	12060-00-3 1303-86-2 1317-36-8 25550-51-0 7439-92-1 79-94-7
REACH Candidate List Substance	2,2',6,6'-tetrabromo-4,4'-isopropylidenediphenol 4-Methyl-1,2-cyclohexanedicarboxylic anhydride Diboron trioxide Lead Lead monoxide Lead titanium oxide (PbTiO ₃)
RoHS Compliance Status	Compliant,With Exemption
RoHS Exemption	6(c) 7(a) 7(c)-I 7(c)-II
SCIP notification number (Bulgaria)	7141b4f4-957e-4315-b10f-7d5a96919a93
SCIP notification number (Czech Republic)	3e128e36-6509-41bb-adac-a32cf2aaff97

Approvals / Certificates

General approvals



Approval	Standard	Certificate Name
EAC GZO Almaty Standart	TP TC 020/2011	EAC CoC 03083
KC National Radio Research Agency	Article 58-2, Clause 3	MSIP-REM-W43-FBC750
UL Underwriters Laboratories Inc. (ORDINARY LOCATIONS)	UL 508	E175199

Declarations of conformity and manufacturer's declarations

Approval	Standard	Certificate Name
EU-Declaration of Conformity WAGO GmbH & Co. KG	-	-
UK-Declaration of Conformity WAGO GmbH & Co. KG	-	-

Approvals for marine applications



Approval	Standard	Certificate Name
ABS American Bureau of Shipping	-	22-2227356-PDA
BSH Bundesamt fuer Seeschifffahrt und Hydrographie	-	1104
DNV DNV Germany GmbH	DNV-CG-0339, Aug. 2021	TAA00001J4
LR Lloyds Register	-	LR2475997TA
PRS Polski Rejestr Statków	-	TE/1102/880590/23

Approvals for hazardous areas



Approval	Standard	Certificate Name
ATEX TUEV Nord Cert GmbH	EN 60079-0	TUEV14ATEX148929X (II 3 G Ex ec IIC T4 Gc)
CCCEX CQST/CNEX	CNCA-C23-01	2020312310000213 (Ex ec IIC T4 Gc)
IECEX TUEV Nord Cert GmbH	IEC 60079-0	IECEX TUN 14.0035 X (Ex ec IIC T4 Gc)
INMETRO TUV Rheinland do Brasil Ltda.	IEC 60079-0	TUV 12.1297 X
UKEX WAGO GmbH & Co. KG	EN 60079-0	UKCA_WA GO22UKEX003X_ec
UL Underwriters Laboratories Inc. (HAZARDOUS LOCATIONS)	UL 121201	E198726

Downloads

Environmental Product Compliance

Compliance Search

Environmental Product Compliance 750-333/025-000	↓
---	---

Documentation

Manual			
Product Manual PROFIBUS DP/ V1 Fieldbus Coupler	V 1.3.1 10.06.2024	pdf 7569.93 KB	↓
System Manual Series 750/753			↓

System Description			
750/753 Series I/O-System – General Product Information		pdf 953.35 KB	↓
Overview on WAGO-I/O-SYSTEM 750 approvals		pdf 770.48 KB	↓

Bid Text			
750-333/025-000	19.02.2019	xml 6.04 KB	↓
750-333/025-000	21.07.2017	doc 28.50 KB	↓

Instruction Leaflet			
CCC Ex (Additional information)	26.04.2023	pdf 159.76 KB	↓

Application Notes

Application Note CoDeSys 2.3			
HART Tool Routing via PROFIBUS with 750-833 and 750-333 (a116140)	1.0.0 22.03.2019	pdf 5214.96 KB	↓

CAD/CAE-Data

CAD data			
2D/3D Models 750-333/025-000			↓

CAE data			
EPLAN Data Portal 750-333/025-000			↓
WSCAD Universe 750-333/025-000			↓
ZUKEN Portal 750-333/025-000			↓

Runtime Software

Firmware			
0750-0333, Feldbus-koppler PROFIBUS DP	V 25 07.07.2025	zip 422.32 KB	↓

Device Files

Device Driver			
WAGO USB Service Kabel Treiber / Serie 750 und 857	6.5.3.0 10.09.2014	zip 4721.96 KB	↓

Libraries

Device Description File			
750-910; GSD files for PROFIBUS / 750, 752, 755, 758 and 767 Series	6.8 15.01.2023	zip 5322.44 KB	↓

1 Compatible Products

1.1 Optional Accessories

1.1.1 Cables and connectors

1.1.1.1 Connector plug



Item No.: 750-960

Fieldbus Connector PROFIBUS; with D-sub male connector; 9-pole

1.1.2 Communication

1.1.2.1 Communication cable



Item No.: 750-923/000-001

Configuration cable; USB connector; Length: 5 m

1.1.3 DIN-rail

1.1.3.1 Mounting accessories



Item No.: 210-196

Aluminum carrier rail; 35 x 8.2 mm; 1.6 mm thick; 2 m long; unslotted; similar to EN 60715; silver-colored



Item No.: 210-198

Copper carrier rail; 35 x 15 mm; 2.3 mm thick; 2 m long; unslotted; according to EN 60715; copper-colored



Item No.: 210-197

Steel carrier rail; 35 x 15 mm; 1.5 mm thick; 2 m long; slotted; similar to EN 60715; silver-colored



Item No.: 210-114

Steel carrier rail; 35 x 15 mm; 1.5 mm thick; 2 m long; unslotted; similar to EN 60715; silver-colored



Item No.: 210-118

Steel carrier rail; 35 x 15 mm; 2.3 mm thick; 2 m long; unslotted; according to EN 60715; silver-colored



Item No.: 210-112

Steel carrier rail; 35 x 7.5 mm; 1 mm thick; 2 m long; slotted; according to EN 60715; "Hole width 25 mm; silver-colored



Item No.: 210-113

Steel carrier rail; 35 x 7.5 mm; 1 mm thick; 2 m long; unslotted; according to EN 60715; silver-colored

1.1.4 Marking

1.1.4.1 Group marker carrier



Item No.: 750-106

Group marker carrier

1.1.4.2 Marker



Item No.: 750-100

Marker card; as a DIN A4 sheet; plain



Item No.: 2009-145/000-006

Mini-WSB In-line; for Smart Printer; 1700 pieces on roll; stretchable 5 - 5.2 mm; plain; snap-on type; blue



Item No.: 2009-145/000-007

Mini-WSB In-line; for Smart Printer; 1700 pieces on roll; stretchable 5 - 5.2 mm; plain; snap-on type; gray



Item No.: 2009-145/000-023

Mini-WSB In-line; for Smart Printer; 1700 pieces on roll; stretchable 5 - 5.2 mm; plain; snap-on type; green



Item No.: 2009-145/000-012

Mini-WSB In-line; for Smart Printer; 1700 pieces on roll; stretchable 5 - 5.2 mm; plain; snap-on type; orange



Item No.: 2009-145/000-005

Mini-WSB In-line; for Smart Printer; 1700 pieces on roll; stretchable 5 - 5.2 mm; plain; snap-on type; red



Item No.: 2009-145/000-024











Mini-WSB In-line; for Smart Printer; 1700 pieces on roll; stretchable 5 - 5.2 mm; plain; snap-on type; violet



Item No.: 2009-145

Mini-WSB In-line; for Smart Printer; 1700 pieces on roll; stretchable 5 - 5.2 mm; plain; snap-on type; white

1.1.4.2 Marker

 <p>Item No.: 2009-145/000-002 Mini-WSB Inline; for Smart Printer; 1700 pieces on roll; stretchable 5 - 5.2 mm; plain; snap-on type; yellow</p>	 <p>Item No.: 248-501/000-006 Mini-WSB marking card; as card; not stretchable; plain; snap-on type; blue</p>	 <p>Item No.: 248-501/000-007 Mini-WSB marking card; as card; not stretchable; plain; snap-on type; gray</p>	 <p>Item No.: 248-501/000-023 Mini-WSB marking card; as card; not stretchable; plain; snap-on type; green</p>
 <p>Item No.: 248-501/000-017 Mini-WSB marking card; as card; not stretchable; plain; snap-on type; light green</p>	 <p>Item No.: 248-501/000-012 Mini-WSB marking card; as card; not stretchable; plain; snap-on type; orange</p>	 <p>Item No.: 248-501/000-005 Mini-WSB marking card; as card; not stretchable; plain; snap-on type; red</p>	 <p>Item No.: 248-501/000-024 Mini-WSB marking card; as card; not stretchable; plain; snap-on type; violet</p>
 <p>Item No.: 248-501 Mini-WSB marking card; as card; not stretchable; plain; snap-on type; white</p>	 <p>Item No.: 248-501/000-002 Mini-WSB marking card; as card; not stretchable; plain; snap-on type; yellow</p>		

1.1.4.3 Marker carrier

 <p>Item No.: 750-103 Group marker carrier</p>
--



1.1.5 Shield termination

1.1.5.1 Shield clamping saddles

 <p>Item No.: 790-108 Shield clamping saddle; 11 mm wide; diameter of compatible conductor; 3 ... 8 mm</p>	 <p>Item No.: 790-208 Shield clamping saddle; 12.4 mm wide; 3 ... 8 mm</p>	 <p>Item No.: 790-116 Shield clamping saddle; 19 mm wide; diameter of compatible conductor; 7 ... 16 mm</p>	 <p>Item No.: 790-216 Shield clamping saddle; 21.8 mm wide; 6 ... 16 mm</p>
 <p>Item No.: 790-124 Shield clamping saddle; 27 mm wide; diameter of compatible conductor; 6 ... 24 mm</p>	 <p>Item No.: 790-220 Shield clamping saddle; 30 mm wide; 6 ... 20 mm</p>	 <p>Item No.: 790-140 Shield clamping saddle; diameter of compatible conductor</p>	

1.1.6 System enclosure

1.1.6.1 System enclosure

 <p>Item No.: 850-825 IP65 enclosure; Aluminium (RAL 7032); WxHxD (160x100x160 mm); 9 x M12, 4 x M20</p>	 <p>Item No.: 850-826 IP65 enclosure; Aluminium (RAL 7032); WxHxD (240x100x160 mm); 4 x M20, 4 x M16, 14 x M12 cable grip</p>	 <p>Item No.: 850-827 IP65 enclosure; Aluminium (RAL 7032); WxHxD (320x100x160 mm); 4 x M20, 8 x M16, 17 x M12 cable grip</p>	 <p>Item No.: 850-828 IP65 enclosure; Aluminium (RAL 7032); WxHxD (480x100x160 mm); 4 x M20, 10 x M16, 35 x M12 cable grip</p>
 <p>Item No.: 850-826/002-000 IP65 enclosure; Aluminium (RAL 7035); WxHxD (240x100x160 mm); 4 x M20, 4 x M16, 14 x M12 cable grip</p>	 <p>Item No.: 850-827/002-000 IP65 enclosure; Aluminium (RAL 7035); WxHxD (320x100x160 mm); 4 x M20, 8 x M16, 17 x M12 cable grip</p>	 <p>Item No.: 850-828/002-000 IP65 enclosure; Aluminium (RAL 7035); WxHxD (480x100x160 mm); 4 x M20, 10 x M16, 35 x M12 cable grip</p>	 <p>Item No.: 850-834 IP65 enclosure; Polyester (RAL 7032); WxHxD (164x100x164 mm); 9 x M12, 4 x M20</p>
 <p>Item No.: 850-835 IP65 enclosure; Polyester (RAL 7032); WxHxD (244x100x164 mm); 4 x M20, 4 x M16, 14 x M12 cable grip</p>	 <p>Item No.: 850-836 IP65 enclosure; Polyester (RAL 7032); WxHxD (324x100x164 mm); 4 x M20, 8 x M16, 17 x M12 cable grip</p>	 <p>Item No.: 850-814/002-000 IP65 enclosure; Sheet steel (RAL 7035); WxHxD (200x120x200 mm); without flange plate</p>	 <p>Item No.: 850-815/002-000 IP65 enclosure; Sheet steel (RAL 7035); WxHxD (300x120x200 mm); without flange plate</p>

1.1.6.1 System enclosure



Item No.: [850-816/002-000](#)

IP65 enclosure; Sheet steel (RAL 7035);
WxD (400x120x200 mm); without flange plate

Item No.: [850-817/002-000](#)

IP65 enclosure; Sheet steel (RAL 7035);
WxD (600x120x200 mm); without flange plate