

Product data sheet Spirotech

Product name

EMCK Duo 125L max 5,6bar

Product properties

The MultiControl Kompakt DUO is an automatic expansion and pressure-maintaining device, with 2 pumps (2x 50%) and an overflow valve. An unpressurised expansion tank is integrated.

- contains 2 pumps (2x 50%)
- contains 1 overflow valve (1x 100%)
- Operational pressure range up to 8.1 bar
- Comes with vessel volumes from 45 to 500 liters
- Two further vessels can be added.
- Maximum expansion volume: 75 – 1,500 litres
- The maximum temperature at the point of connection: 70°C (over 70°C possible with auxiliary tank)
- Maximum safety temperature in the system: 110°C
- Maximum operating pressure (PN): 10 bar

Article number

EMCK-D125-5.6

Product image



Product dimensions

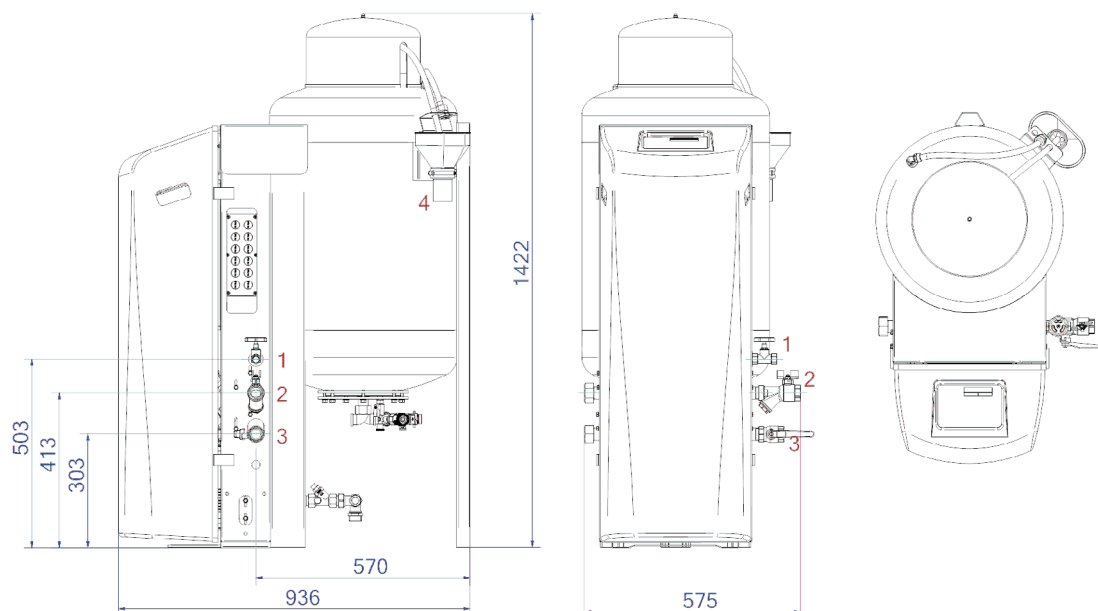

1. Refill connection

Rp1/2

2. Expansion overflow pipe

Rp1

3. Expansion pressure pipe

Rp1

4. Drain funnel tank safety valve

DN50 Geberit

Product data sheet Spirotech

ETIM product data

Height	1405 mm	Double pump	Yes
Volume	125 l	With exchangeable membrane	Yes
Max. operating pressure	5.6 bar	Compressor in base	No
Connection	Other	Nominal diameter expansion connection	1 inch (25)
Power consumption	1.1 kW	Max. medium temperature (continuous)	70 °C
Couplable	Yes	For heating systems up to	1 MW
Electrical connection	Connection cable with plug	Horizontal positioning	No
Function master/slave	No	Connection voltage	230 V
With pressure expansion vessel	Yes	Article compression class	PN 10
Digital control unit	Yes		

Disclaimer

This product sheet has been compiled with the greatest possible care. Nevertheless, it may contain errors or omissions. For the most current and correct information we refer you to our website

