

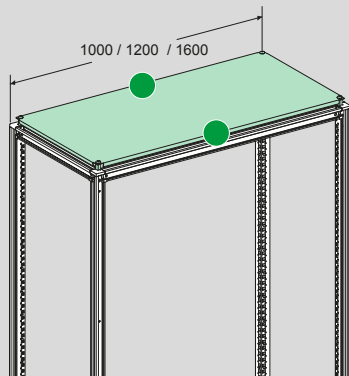



B NSYRE26





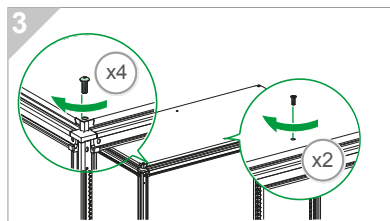
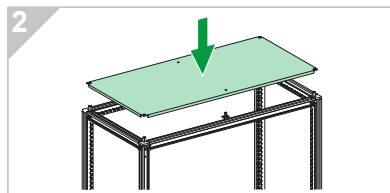
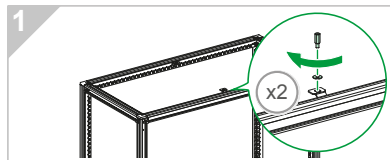

 (2X)
 NSYEX206 (2X)  M6 X 10 (2X)

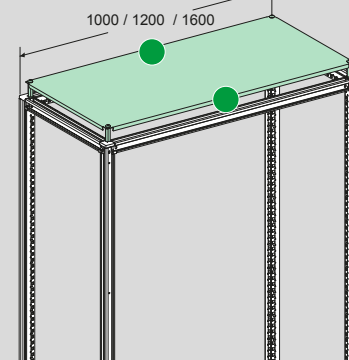

C NSYRE60



 (2X)
 NSYEX206 (2X)  NSYEX406 (2X)
 M6 X 10 (2X)

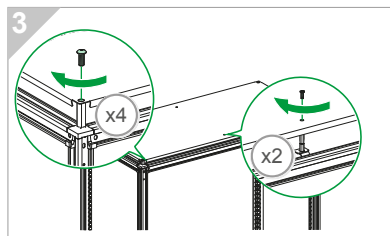
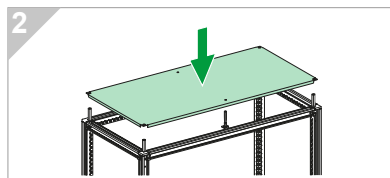
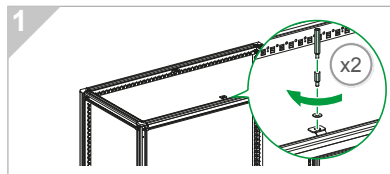

Ventilation Elevators for Roof
 Entretoise de Toit
 Elevadores de Aireación para Techo

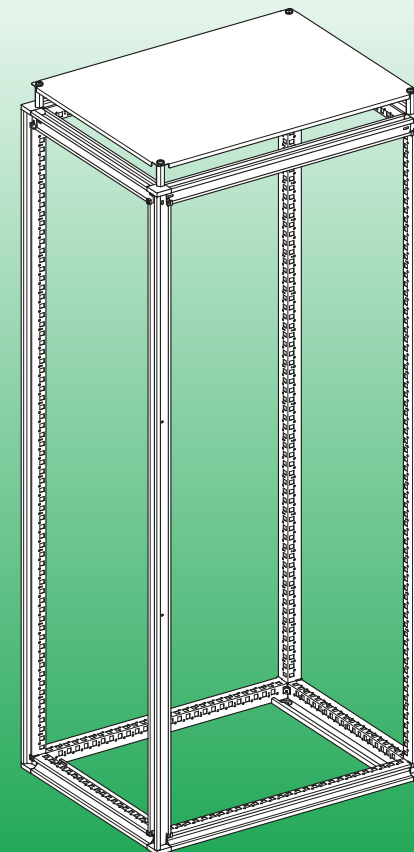

 type 1
 diam.12

Schneider Electric Industries SAS

35, rue Joseph Monier
 CS 30323
 F - 92506 Rueil Malmaison Cedex

RCS Nanterre 954 503 439
 Capital social 896 313 776 €
 www.schneider-electric.com
 7313650001-05

© 2014 Schneider Electric - Tous droits réservés - All rights reserved.

En raison de l'évolution des normes et du matériel, les caractéristiques indiquées par le texte et les images de ce document ne nous engageant qu'après confirmation par nos services.

As standards, specifications and designs change from time to time, please ask for confirmation of the information given in this publication.

Publication : Schneider Electric
 Réalisation : Ameg
 Impression :



Ce document a été imprimé sur du papier écologique.
 This document has been printed on ecological paper.

Schneider
Electric

Released for Manufacturing
 Printed on 2014/05/07

A

