

Productinformatieblad

Specificaties



Koelunit dakmontage, ClimaSys CU, 600W, 230V, 50/60Hz, IP54

NSYCU600RDG

EAN Code: 3606486055335

Prijs: 2.075,00 EUR

Hoofd

range	ClimaSys
product name	CU
productmontage	Dakplaat kast
product or component type	Koelgroep
Installatie	Binnen dak
bestemming product	Voor kast
mounting mode	Met schroeven
Voedingsspanning	220...240 V 1 fase 50 Hz EN/IEC 230 V +/- 6 % 1 fase 60 Hz UL
Nominaal vermogen	650 W
koelvermogen	650 W 50/60 Hz L35-L35 580 W 50/60 Hz L35-L50

Complementair

hoogte	368 mm
breedte	400 mm
diepte	325 mm
[In] rated current	2,2 A
inschakelstroom	6 A
maximaal energieverbruik in W	340 W bij 50/60 Hz, L35-L35 390 W bij 50/60 Hz, L35-L50
energie-efficiëntieverhouding	1,9
control type	Elektronische regelaar
temperatuurinstelbereik	20...50 °C bij 50/60 Hz
omgevingsluchttemperatuur voor werking	In de behuizing: 20...50 °C bij 50/60 Hz Buiten de behuizing: 5...55 °C bij 50/60 Hz
Geluidsniveau	55 dB
druk	28 bar
luchtstroom	Intern circuit: 180 m3/h bij 50/60 Hz Extern circuit: 408 m3/h bij 50/60 Hz
net weight	16,8 kg
koelgastype	R134a (0,120 kg)
type filter	Optionele externe circuitfilter

De weergegeven prijs is de adviesprijs in euro excl. BTW. Deze kan onderhevig zijn aan korting. Neem contact op met uw lokale distributeur of detailhandel voor de daadwerkelijke prijs

Recommended circuit breaker protection	M9F23116
Thermal protection Recommended (fuse)	15 A (T)
materiaal	Staal
colour	Grijs (RAL 7035)

Omgeving

product certifications	UL IEC EN
richtlijnen	2006/42/EG - Machinerichtlijn 2014/30/EU - elektromagnetische compatibiliteit 2011/65/EU - RoHS
standards	EN/ISO 12100 EN 60335-1 EN 60335-2-40 EN 61000-3-2 EN 61000-3-3 EN 61000-6-2 EN 61000-6-3 EN/IEC 63000:2018 EN 14511
IP beschermingsgraad	IP54 conform aan IEC 60529 (op het interne circuit) IP24 conform aan IEC 60529 (op het externe circuit)

Verpakkingseenheid

Unit Type of Package 1	PCE
Number of Units in Package 1	1
Package 1 Height	35,500 cm
Package 1 Width	41,500 cm
Package 1 Length	48,000 cm
Package 1 Weight	20,000 kg
Unit Type of Package 2	P12
Number of Units in Package 2	8
Package 2 Height	100,000 cm
Package 2 Width	80,000 cm
Package 2 Length	120,000 cm
Package 2 Weight	178,000 kg

Environmental Data

Schneider Electric wil tegen 2050 de Net Zero-status hebben bereikt via partnerschappen in de toeleveringsketen, materialen met een lagere impact en circulariteit via onze doorlopende campagne "Use Better, Use Longer, Use Again" om de levensduur van producten en de recycleerbaarheid te verlengen.

[Uitleg van Environmental Data](#) >

[Hoe evalueren we de duurzaamheid van producten?](#) >

Milieuoetafdruk

Totale levenscyclus ecologische voetafdruk 1085

Milieuprofiel van product (PEP) [Milieuprofiel van het product](#)

Use Better

Materialen en verpakking

F-gasvrij Product containing F-gas

Pakket met gerecycleerd karton Ja

Verpakkingen zonder kunststof Nee

[EU-richtlijn RoHS](#) Voldoet

REACH-regelgeving [REACH-verklaring](#)

Use Again

Herverpakken en herfabriceren

Circulair Profiel [Informatie over einde levensduur](#)

Terugname No

WEEE Label  Het product moet op markten van de Europese Unie worden afgevoerd volgens specifieke afvalinzamelingsregels en mag nooit in een gewone vuilnisbak terechtkomen.

Technical Illustration

Dimensions

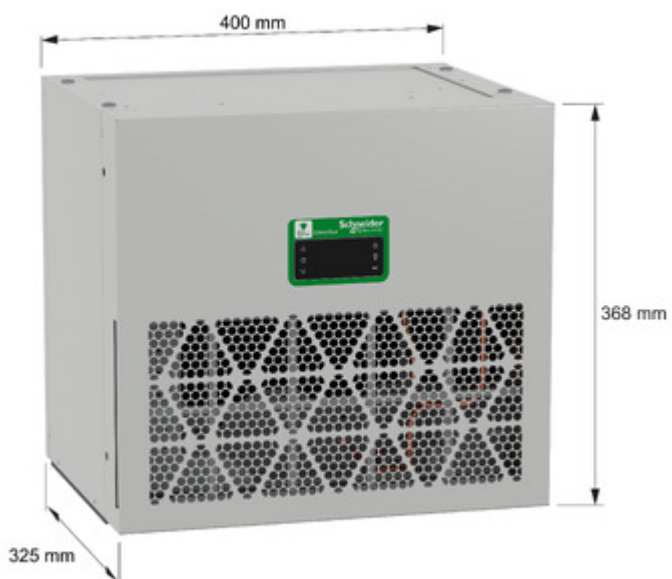

Offer Marketing Illustration

Energy Label



Technical Illustration

Exploded view



Technical Illustration

Exploded view



Image of product / Alternate images

Alternative









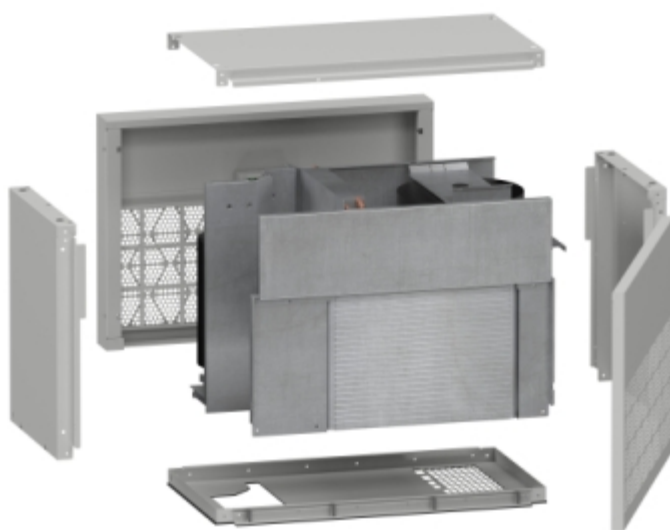
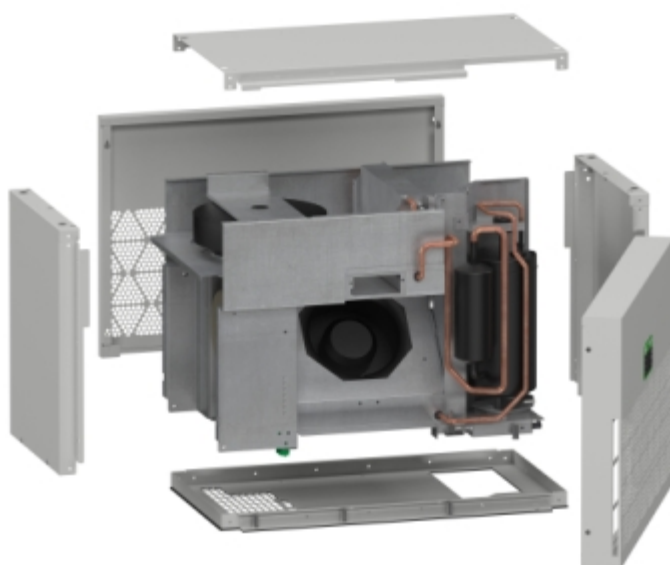

Image of product in real life situation

