









33 876 760



- Ausladung 206 mm
- schwenkbarer Auslauf 130°
- luftangereicherter Strahl und Brausestrahl
- Armaturenhöhe 253 mm
- Höhe bis Luftsprudler 179 mm
- Bohrungsdurchmesser 35 mm
- 2x Europäischer Druckschlauch
- Metallbrauseschlauch 1600 mm
- Durchfluss max. 9,6 l/min bei 3 bar Fließdruck
- bleifrei
- Dieses Produkt leistet einen Beitrag zur Erfüllung der Vorgaben von nachhaltigen Gebäudezertifizierungen, z.B. LEED®, BREEAM®, DGNB

Eigensicher gegen Rückfließen.

	Chrom	33 876 760-00
	Platin gebürstet	33 876 760-06
	Platin	33 876 760-08
	Dark Chrome	33 876 760-19
	Messing gebürstet (23kt Gold)	33 876 760-28
	Champagne gebürstet (22kt Gold)	33 876 760-46
	Champagne (22kt Gold)	33 876 760-47
	Chrom gebürstet (Edelstahl-Look)	33 876 760-93
	Dark Platinum gebürstet	33 876 760-99

**Empfohlenes Zubehör**

**Exzenterbetätigung mit Drehknopf - Chrom** 10 712 970-00



**Empfohlenes Zubehör**

**Spender ohne Rosette - Chrom** 82 424 970-00



33 876 760

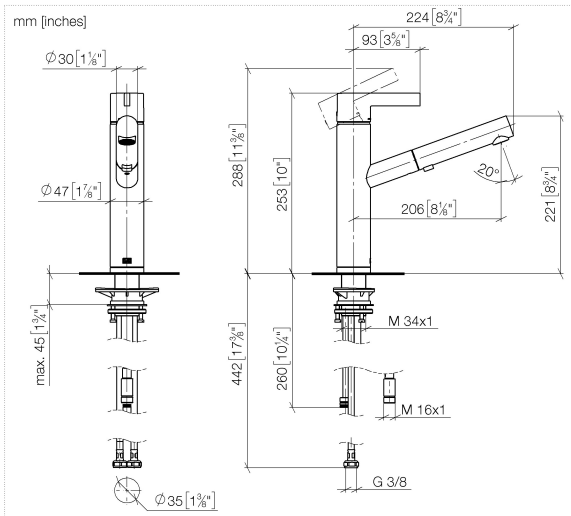

**Durchflussdiagramm**

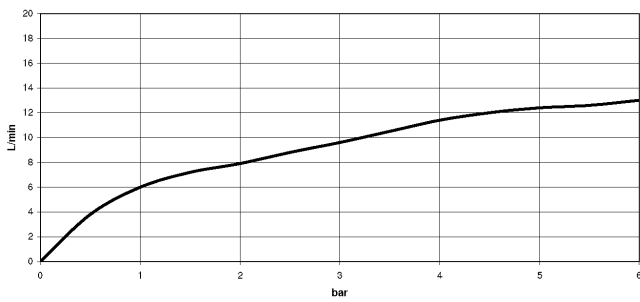



## ENO Einhebelmischer Pull-out mit Brausefunktion - Chrom

---

ENO

33 876 760



## Ersatzteilstückliste