

Concord

Solstice 200 1800lm 940 DALI GB
2070230



Features

- The Solstice 200 1800lm 940 DALI GB is a high efficient DALI dimmable downlight luminaire, Colour rendering index Ra>90, Colour temperature: 4000K Neutral White, Class II, Protection rating IP40/IP20, Cut out dimensions: 200mm.

Product Overview

Product name	Solstice 200 1800lm 940 DALI GB
Technology	LED
Cap/Base	N/A
Housing	Aluminium
Mount	Ceiling recessed mounting
E-number FI	4262095
Fixture luminous flux (lm)	1800
Luminaire efficacy (lm/W)	106
LOR (%)	100
Colour temperature (K)	4000
Light colour	Neutral White
CRI (Ra)	90
Colour Consistency (SDCM)	3
Colour Variation Initial (SDCM)	3
Glare control	< 20
Photobiological Risk Group	RG1
Total power consumption (W)	17
Electrical protection	Class II
Control gear type	LED driver constant current
LED Flickering Rate	Ultra low (5% or less)
Housing colour	RAL 9005 - Jet black

Concord

Solstice 200 1800lm 940 DALI GB
2070230

IP rating	IP40/20
IK rating	IK02
Product EAN number	5025768702305
Warranty	5 years

Photometry

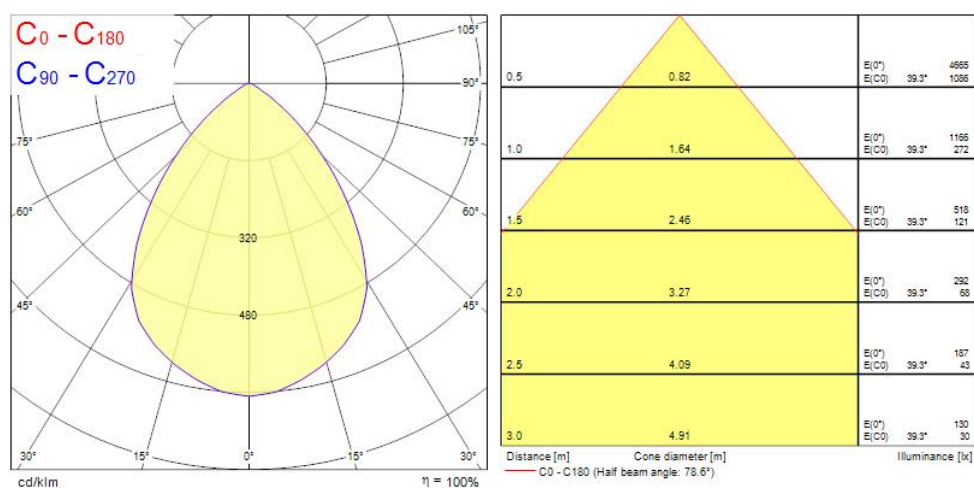

Technical drawings

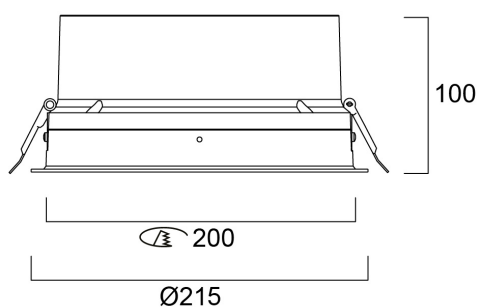

Concord

Solstice 200 1800lm 940 DALI GB
2070230

Data table

GENERAL DATA

Product name	Solstice 200 1800lm 940 DALI GB
Technology	LED
Cap/Base	N/A
Housing	Aluminium
Mount	Ceiling recessed mounting
Operating temperature range (°C)	-10°C...+40°C
Performance ambient temperature Tq (°C)	40
E-number FI	4262095
Warranty	5 years

OPTICAL DATA

Fixture luminous flux (lm)	1800
Luminaire efficacy (lm/W)	106
LOR (%)	100
Colour temperature (K)	4000
Light colour	Neutral White
CRI (Ra)	90
Colour Consistency (SDCM)	3
Colour Variation Initial (SDCM)	3
Glare control	< 20
Photobiological Risk Group	RG1

ELECTRICAL DATA

Total power consumption (W)	17
Primary Supply/Product voltage - min (V)	220
Lamp power factor	0.96
Electrical protection	Class II
Control gear required	No
Control gear type	LED driver constant current

Concord

Solstice 200 1800lm 940 DALI GB 2070230

Drive current (mA)	450
Inrush Current (A)	25
Inrush Duration (µs)	141
Glow Wire Test (°C)	850
Energy Efficiency Class (A->G) of contained light source	C
Nominal Frequency (Hz)	50/60Hz
LED Flickering Rate	Ultra low (5% or less)
Max. products per 10A C Breaker	31
Max. products per 20A B Breaker	40
Connectable conductor cross section - Min (mm ²)	0.5
Connectable conductor cross section - Max (mm ²)	2.5

LIFETIME DATA

Lifespan L70 B50	120000
Lifespan L80 B20	120000
Lifespan L80 B10	120000
Lifespan L90 B10	68000

PHYSICAL DATA

Housing colour	RAL 9005 - Jet black
IP rating	IP40/20
IK rating	IK02
Diffuser finish	Diffuse
Diffuser material	PC Polycarbonate
Nominal Product Diameter (mm)	215
Max. Lamp Diameter (mm) - D	215
Weight (kg)	1.3
Recessed Depth (mm)	150

PACKAGING

Single packaging type	Carton
-----------------------	--------

Concord

Solstice 200 1800lm 940 DALI GB
2070230

Product EAN number	5025768702305
Packaging single width (cm)	30.0
Packaging single depth (cm)	12.5
DUN14 (outer)	05025768702305
Packaging outer length / height (cm)	30.0

SAFETY DATA

Optimal operating condition (°C)	-10-40
Special purpose lamp	No
Dry applications use only	No
Suitable for household illumination	No