

Data Sheet | Item Number: 280-533

Double-deck terminal block; Through/through terminal block; for DIN-rail 35 x 15 and 35 x 7.5; 2.5 mm²; CAGE CLAMP®; 2,50 mm²; gray/blue

<https://www.wago.com/280-533>

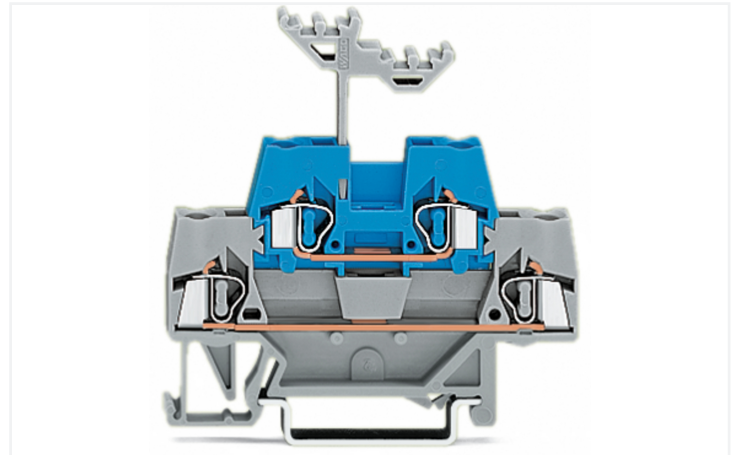
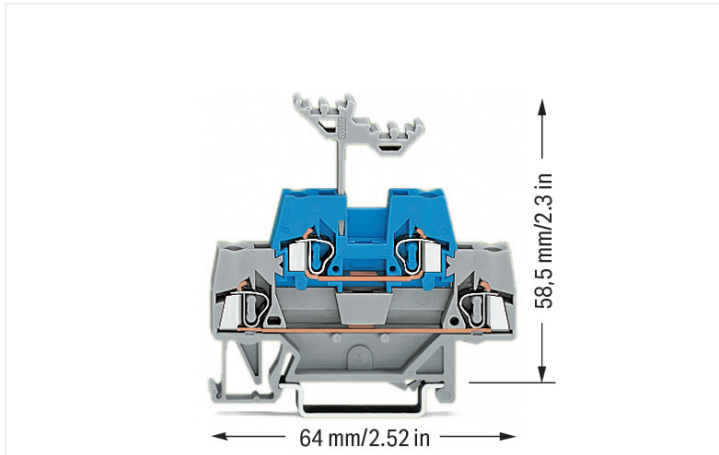

Color: ■ gray/blue

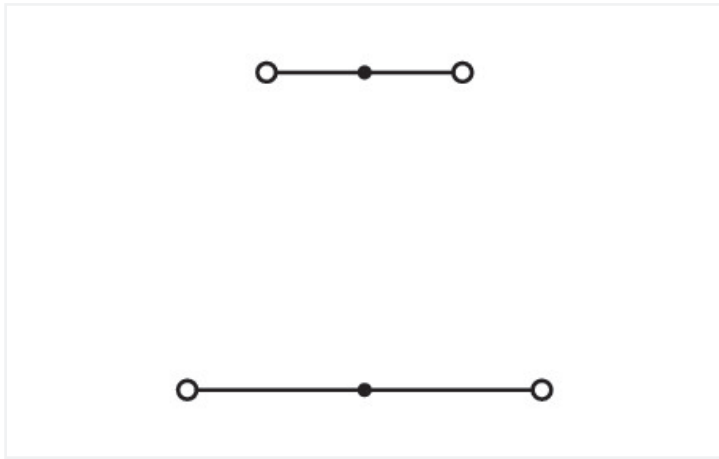

Similar to illustration

Double-deck terminal block, 280 Series, operating tool

Our double-deck terminal block (item number 280-533) simplifies electrical installations. Strip lengths must be between 8 and 9 mm when connecting conductors to this double-deck terminal block. The double-deck terminal block also functions as a through terminal block. This product features conductor terminals and utilizes CAGE CLAMP®. Our CAGE CLAMP® connection offers a convenient and maintenance-free way to connect all types of conductors. You do not need to prepare the conductor in any way, such as crimping ferrules. Depending on the conductor type, this double-deck terminal block is suitable for conductor cross sections ranging from 0.08 mm² to 2.5 mm².

Electrical data

| Ratings per | IEC/EN 60947-7-1 | | |
|---------------------------------|------------------|-----|----|
| Overvoltage category | III | III | II |
| Pollution degree | 3 | 2 | 2 |
| Nominal voltage | 500 V | - | - |
| Rated impulse withstand voltage | 6 kV | - | - |
| Rated current | 20 A | - | - |

| Power Loss | |
|--|-----------|
| Power loss, per pole (potential) | 0.532 W |
| Rated current I _N for power loss specification | 20 A |
| Resistance value for specified, current-dependent power loss | 0.00133 Ω |

General information

| | |
|------------------|--------------------|
| Wiring direction | Front-entry wiring |
|------------------|--------------------|

Connection Data

| | |
|----------------------------|---|
| Clamping units | 4 |
| Total number of potentials | 2 |
| Number of levels | 2 |

Connection 1

| | |
|---------------------------------|--------------------|
| Connection technology | CAGE CLAMP® |
| Actuation type | Operating tool |
| Connectable conductor materials | Copper Aluminum |

Connectable conductor materials (note) **Terminating Aluminum Conductors**
WAGO Spring-Clamp Terminal Blocks are suitable for solid aluminum conductors up to 4 mm²/12 AWG if WAGO "Alu-Plus" Contact Paste [249-130](#) is used for termination.

"Alu-Plus" Contact Paste Advantages:

- Automatically destroys the oxide film during clamping.
- Prevents fresh oxidation at the clamping point.
- Prevents electrolytic corrosion between aluminum and copper conductors (in the same terminal block).
- Provides long-term protection against corrosion.

Using terminal blocks with CAGE CLAMP® Spring Pressure Connection Technology, **aluminum conductors must first be cleaned with a blade** and then immediately inserted into the clamping units filled with "Alu-Plus" contact paste.

It is also possible to apply WAGO "Alu-Plus" **additionally** on the whole surface of the aluminum conductor before termination.

Please note that the nominal currents must be adapted to the reduced conductivity of the aluminum conductors:
2.5 mm² = 16 A
4 mm² = 22 A

| | |
|--------------------------------|--|
| Solid conductor | 0.08 ... 2.5 mm ² / 28 ... 12 AWG |
| Fine-stranded conductor | 0.08 ... 2.5 mm ² / 28 ... 12 AWG |
| Note (conductor cross-section) | 12 AWG: THHN, THWN |
| Strip length | 8 ... 9 mm / 0.31 ... 0.35 inches |
| Wiring direction | Front-entry wiring |

Physical data

| | |
|-----------------------------------|------------------------|
| Width | 5 mm / 0.197 inches |
| Height | 64 mm / 2.52 inches |
| Depth from upper-edge of DIN-rail | 58.5 mm / 2.303 inches |

Mechanical data

| | |
|---------------|-----------------|
| Design | horizontal type |
| Mounting type | DIN-35 rail |
| Marking level | Center marking |

Material data

| | |
|------------------------------------|--|
| Note (material data) | Information on material specifications can be found here |
| Color | gray/blue |
| Material group | I |
| Insulation material (main housing) | Polyamide (PA66) |
| Flammability class per UL94 | V0 |
| Fire load | 0.17 MJ |
| Weight | 10.2 g |

Environmental requirements

| | |
|----------------------------------|-----------------|
| Processing temperature | -35 ... +85 °C |
| Continuous operating temperature | -60 ... +105 °C |

Commercial data

| | |
|-----------------------|----------------------------------|
| Product Group | 1 (Rail Mounted Terminal Blocks) |
| PU (SPU) | 50 pcs |
| Packaging type | Box |
| Country of origin | DE |
| GTIN | 4044918501859 |
| Customs tariff number | 85369010000 |

Product Classification

| | |
|-------------|----------------------|
| UNSPSC | 39121410 |
| eCl@ss 10.0 | 27-14-11-20 |
| eCl@ss 9.0 | 27-14-11-20 |
| ETIM 9.0 | EC000897 |
| ETIM 10.0 | EC000897 |
| ECCN | NO US CLASSIFICATION |

Environmental Product Compliance

| | |
|------------------------|-------------------------|
| RoHS Compliance Status | Compliant, No Exemption |
|------------------------|-------------------------|

Approvals / Certificates

General approvals



| Approval | Standard | Certificate Name |
|---------------------------------------|----------|------------------|
| CSA DEKRA Certification B.V. | C22.2 | 1536071 |
| KEMA/KEUR DEKRA Certification B.V. | EN 60947 | 71-154769 |
| UR Underwriters Laboratories Inc. | UL 1059 | E45172 |

Declarations of conformity and manufacturer's declarations

| Approval | Standard | Certificate Name |
|--|----------|------------------|
| EU-Declaration of Conformity WAGO GmbH & Co. KG | - | - |
| UK-Declaration of Conformity WAGO GmbH & Co. KG | - | - |

Approvals for marine applications



| Approval | Standard | Certificate Name |
|---|----------|------------------|
| ABS American Bureau of Ship- ping | EN 60947 | 24-0152298-PDA |
| BV Bureau Veritas S.A. | EN 60947 | 07436/G0 BV |
| DNV GL Det Norske Veritas, Ger- manischer Lloyd | - | TAE00001V2 |

Downloads

Environmental Product Compliance

| Compliance Search |
|---|
| Environmental Product Compliance 280-533 ↓ |

Documentation

| Bid Text | | | |
|----------|------------|-----------------|-------------------|
| 280-533 | 19.02.2019 | xml 3.35 KB | ↓ |
| 280-533 | 28.02.2017 | doc 24.50 KB | ↓ |

CAD/CAE-Data

| CAD data |
|--|
| 2D/3D Models 280-533 ↓ |

| CAE data |
|--|
| EPLAN Data Portal 280-533 ↓ |
| WSCAD Universe 280-533 ↓ |
| ZUKEN Portal 280-533 ↓ |

1 Compatible Products

1.1 Required Accessories

1.1.1 End plate

1.1.1.1 End plate



Item No.: 280-340
End and intermediate plate; 2.5 mm thick; gray



Item No.: 280-341
End and intermediate plate; 2.5 mm thick; orange



Item No.: 280-366
Intermediate plate; 1.1 mm thick; orange

1.2 Optional Accessories

1.2.1 DIN-rail

1.2.1.1 Mounting accessories



Item No.: 210-196
Aluminum carrier rail; 35 x 8.2 mm; 1.6 mm thick; 2 m long; unslotted; similar to EN 60715; silver-colored



Item No.: 210-198
Copper carrier rail; 35 x 15 mm; 2.3 mm thick; 2 m long; unslotted; according to EN 60715; copper-colored



Item No.: 210-508
Steel carrier rail; 35 x 15 mm; 1.5 mm thick; 2 m long; slotted; galvanized; similar to EN 60715; silver-colored



Item No.: 210-197
Steel carrier rail; 35 x 15 mm; 1.5 mm thick; 2 m long; slotted; similar to EN 60715; silver-colored



Item No.: 210-506
Steel carrier rail; 35 x 15 mm; 1.5 mm thick; 2 m long; unslotted; galvanized; similar to EN 60715; silver-colored



Item No.: 210-114
Steel carrier rail; 35 x 15 mm; 1.5 mm thick; 2 m long; unslotted; similar to EN 60715; silver-colored



Item No.: 210-118
Steel carrier rail; 35 x 15 mm; 2.3 mm thick; 2 m long; unslotted; according to EN 60715; silver-colored



Item No.: 210-115
Steel carrier rail; 35 x 7.5 mm; 1 mm thick; 2 m long; slotted; according to EN 60715; silver-colored



Item No.: 210-112
Steel carrier rail; 35 x 7.5 mm; 1 mm thick; 2 m long; slotted; according to EN 60715; silver-colored



Item No.: 210-504
Steel carrier rail; 35 x 7.5 mm; 1 mm thick; 2 m long; slotted; galvanized; according to EN 60715; silver-colored



Item No.: 210-113
Steel carrier rail; 35 x 7.5 mm; 1 mm thick; 2 m long; unslotted; according to EN 60715; silver-colored



Item No.: 210-505
Steel carrier rail; 35 x 7.5 mm; 1 mm thick; 2 m long; unslotted; galvanized; according to EN 60715; silver-colored

1.2.2 Ferrule

1.2.2.1 Ferrule



Item No.: 216-301
Ferrule; Sleeve for 0.25 mm² / AWG 24; insulated; electro-tin plated; yellow



Item No.: 216-302
Ferrule; Sleeve for 0.34 mm² / 22 AWG; insulated; electro-tin plated; light turquoise



Item No.: 216-201
Ferrule; Sleeve for 0.5 mm² / 20 AWG; insulated; electro-tin plated; electrolytic copper; acc. to DIN 46228, Part 4/09.90; white



Item No.: 216-101
Ferrule; Sleeve for 0.5 mm² / AWG 22; un-insulated; electro-tin plated; silver-colored



Item No.: 216-202
Ferrule; Sleeve for 0.75 mm² / 18 AWG; insulated; electro-tin plated; gray



Item No.: 216-102
Ferrule; Sleeve for 0.75 mm² / AWG 20; un-insulated; electro-tin plated; silver-colored



Item No.: 216-203
Ferrule; Sleeve for 1 mm² / AWG 18; insulated; electro-tin plated; red



Item No.: 216-103
Ferrule; Sleeve for 1 mm² / AWG 18; un-insulated; electro-tin plated



Item No.: 216-204
Ferrule; Sleeve for 1.5 mm² / AWG 16; insulated; electro-tin plated; black



Item No.: 216-104
Ferrule; Sleeve for 1.5 mm² / AWG 16; un-insulated; electro-tin plated; silver-colored

1.2.3 Installation

1.2.3.1 Cover



Item No.: 709-154

Cover; Type 2; suitable for cover carrier, type 2; 1 m long; transparent

1.2.3.2 Cover carrier



Item No.: 709-168

Cover carrier; Type 2; incl. fixing/retaining screws and knurled nut; suitable for 283 to 285 Series rail-mounted terminal blocks; suitable for 279 to 281 Series double- and triple-deck terminal blocks; suitable for 780 to 785, 775, 776 and 777 Series TOP-JOB® rail-mounted terminal blocks; suitable for 280 Series sensor and actuator terminal blocks; suitable for 282 Series disconnect/test terminal blocks for transformer circuits; gray

1.2.3.3 Mounting accessories



Item No.: 209-106

Mounting carrier; for isolated mounting on DIN 35 rails; gray



Item No.: 249-116

Screwless end stop; 6 mm wide; for DIN-rail 35 x 15 and 35 x 7.5; gray

1.2.4 Insulation stop

1.2.4.1 Insulation stop



Item No.: 280-470

Insulation stop; 0.08 - 0.2 mm² "s" (0.14 mm² "f-st"); 5 pieces/strip; white



Item No.: 280-471

Insulation stop; 0.25 - 0.5 mm²; 5 pieces/strip; light gray



Item No.: 280-472

Insulation stop; 0.75 - 1 mm²; 5 pieces/strip; black

1.2.5 Jumper

1.2.5.1 Jumper



Item No.: 280-490

Jumper; 10-way; insulated; gray



Item No.: 280-482

Jumper; 2-way; insulated; gray



Item No.: 280-492

Jumper; 2-way; insulated; gray



Item No.: 280-483

Jumper; 3-way; insulated; gray



Item No.: 280-484

Jumper; 4-way; insulated; gray



Item No.: 280-485

Jumper; 5-way; insulated; gray



Item No.: 280-402

Jumper; insulated; gray



Item No.: 280-409

Jumper; insulated; gray



Item No.: 780-452

Staggered jumper; from 1 to 2; insulated; gray



Item No.: 780-453

Staggered jumper; from 1 to 3; insulated; gray



Item No.: 780-454

Staggered jumper; from 1 to 4; insulated; gray



Item No.: 780-455

Staggered jumper; from 1 to 5; insulated; gray

1.2.5.1 Jumper



Item No.: 780-456

Staggered jumper; from 1 to 6; insulated; gray



Item No.: 780-457

Staggered jumper; from 1 to 7; insulated; gray



Item No.: 780-458

Staggered jumper; from 1 to 8; insulated; gray



Item No.: 281-421

Vertical jumper; insulated; gray



Item No.: 709-110

Wire commoning chain; 2.5 mm²; insulated; black



Item No.: 709-111

Wire commoning chain; 2.5 mm²; insulated; black

Item No.: 709-112

Wire commoning chain; 2.5 mm²; insulated; black

Item No.: 210-103

Wire commoning chain; insulated; black

Item No.: 210-123

Wire commoning chain; insulated; blue

1.2.6 Marking

1.2.6.1 Marker



Item No.: 793-5501

WMB marking card; as card; for terminal block width 5 - 17.5 mm; stretchable 5 - 5.2 mm; plain; snap-on type; white

Item No.: 793-501

WMB marking card; as card; not stretchable; plain; snap-on type; white

Item No.: 2009-115

WMB-Inline; for Smart Printer; 1500 pieces on roll; stretchable 5 - 5.2 mm; plain; snap-on type; white

1.2.7 Protective warning marker

1.2.7.1 Cover



Item No.: 280-415

Protective warning marker; for 5 terminal blocks; with high-voltage symbol, black; yellow

1.2.8 Push-in type wire jumper

1.2.8.1 Jumper



Item No.: 249-126

Push-in type wire jumper; 0.75 mm²; insulated; 110 mm long; black

Item No.: 249-123

Push-in type wire jumper; 0.75 mm²; insulated; 180 mm long; black

Item No.: 249-127

Push-in type wire jumper; 0.75 mm²; insulated; 250 mm long; black

Item No.: 249-125

Push-in type wire jumper; insulated; 60 mm long; black

1.2.9 Test and measurement

1.2.9.1 Testing accessories



Item No.: 249-142

L-type end module; modular; with rigid contact pin; End module; 1,50 mm²; gray

Item No.: 249-141

L-type test plug module; modular; with spring-loaded contact pin; Center module; 1,50 mm²; gray

1.2.10 Tool

1.2.10.1 Operating tool



Item No.: 210-658

Operating tool; Blade: 3.5 x 0.5 mm; with a partially insulated shaft; angled; short; multicoloured



Item No.: 210-720

Operating tool; Blade: 3.5 x 0.5 mm; with a partially insulated shaft; multicoloured



Item No.: 210-657

Operating tool; Blade: 3.5 x 0.5 mm; with a partially insulated shaft; short; multicoloured

Installation Notes

Installation



Snapping a terminal block onto the DIN-rail.

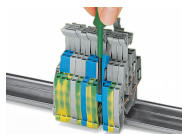

Removing a terminal block from the assembly.



Double-deck terminal blocks accommodate two circuits of different potentials on two decks; different circuits can be differentiated by color coding either deck (280 Series). The lower deck is wider than the upper for easier wiring.

Conductor termination

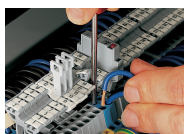

The flexible marker carrier, which is placed above the wiring level, can be pushed aside during wiring or commoning. The carrier has two staggered levels for WMB markers that perfectly align with the terminal block decks.

Commoning



Commoning using an adjacent jumper. Push jumpers down until fully inserted!

Commoning

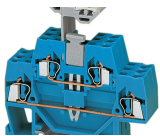

Commoning with a vertical jumper (281-421). Push vertical jumper down until fully inserted!

Combining vertical and adjacent jumpers.

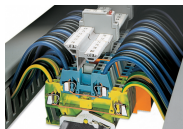

Example of a mixed assembly with double-deck terminal blocks. The 280 Series Double-Deck Terminal Blocks are available with decks of same or different color according to their function. This is an additional visual aid during wiring, service or maintenance.

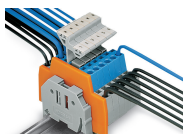

Double-deck terminal blocks used as control conductor terminal blocks (e.g., for magnetic valves) with the upper deck commoned.

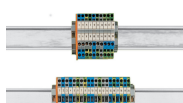

With a terminal block width of just 5 mm, an effective width of just 2.5 mm for terminal blocks of same or different potentials can be realized for conductors ranging 0.08 mm² ... 2.5 mm² (28 ... 14 AWG).

Use 50% less rail space with double-deck terminal blocks.

Marking

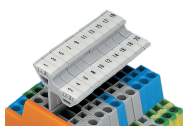

Labeling via WMB Multi Marking System.

Subject to changes. Please also observe the further product documentation!

Current addresses can be found at: www.wago.com