













Soap dish , wall model - Durabronz (23kt Gold)

SERIES-VARIOUS

83 410 979 Product version from 10/1/2023

- width 120mm
- height 20 mm
- 145mm projection



	Durabronz (23kt Gold)	83 410 979-09
	Chrome	83 410 979-00
	Brushed Platinum	83 410 979-06
	Platinum	83 410 979-08
	Dark Chrome	83 410 979-19
	Light Gold (PVD)	83 410 979-26
	Brushed Light Gold (PVD)	83 410 979-27
	Brushed Durabronz (23kt Gold)	83 410 979-28
	Matte Black	83 410 979-33
	Brushed Gold (PVD)	83 410 979-37
	Brushed Dark Brass (PVD)	83 410 979-39
	Brushed Bronze (PVD)	83 410 979-42
	Brushed Dark Bronze (PVD)	83 410 979-43
	Brushed Champagne (22kt Gold)	83 410 979-46
	Champagne (22kt Gold)	83 410 979-47
	Brushed Chrome	83 410 979-93
	Brushed Dark Platinum	83 410 979-99

83 410 979 Product version from 10/1/2023

mm [inches]

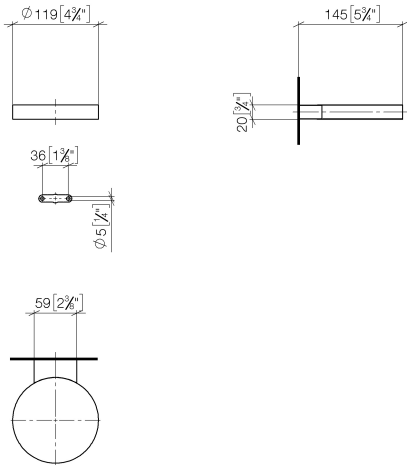

83 410 979 Product version from 10/1/2023

Parts for other finishes can be found here: Chrome

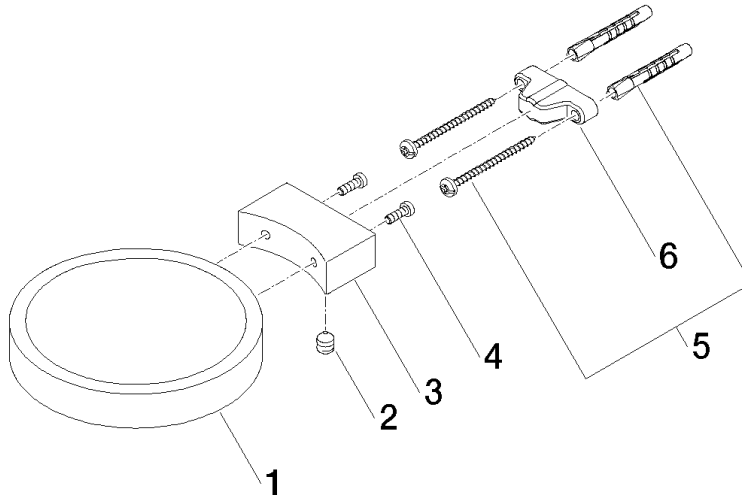

Spare parts list

No.	Item Number	Name	Quantity used	Delivery time
3	08 17 30 502-09	Holder for soap dish 60 x 34 x 20 mm - Durabronss (23kt Gold)	1.00	54
2	09 31 11 002 90	Mounting Threaded pin with hexagon socket M8 x 10 mm -	1.00	14
1	08 17 97 570-09	Soap dish Ø 120 x 20 mm - Durabronss (23kt Gold)	1.00	54
4	09 30 30 080 90	Mounting Cylinder head screw with hexagon socket Low profile M4 x 12 mm -	2.00	14
5	05 30 31 025 00 90	Mounting Bolt Round head 4,5 x 60 mm -	1.00	14
6	09 17 20 030 90	Mounting Wall bracket 46 x 22 x 12 mm -	1.00	14