



### Atlantic LED II CG-S

- LED exit sign luminaire with high protection class (IP66) for indoor and outdoor use
- An integrated pressure equalization membrane reduces the effects of condensation in changing weather conditions
- Luminaire with limited surface temperatures for use in operating areas with fire hazard
- Acc. HACCP suitable for use in food processing industry
- Robust construction from aluminium diecast and high impact resistant cover made of polycarbonate
- Numerous knock-outs for cable entries and double terminal for through-wiring
- Minimum service requirement due to high service life of the LEDs (up to 50.000 hours)
- Shortened inspection effort due to CEWA GUARD technology
- Automatic function monitoring of up to 20 luminaires per circuit
- Reduced installation expenditures by STAR technology
- Freely programmable mixed operation of the switching modes per luminaire in one circuit

Atlantic LED II S CG-S



Atlantic LED II D CG-S



Viewing distance	24 m
Luminous flux $\Phi_E/\Phi_N$ at the end of rated operating time	100 %
Housing material	Enclosure: Aluminium diecast Cover: Polycarbonate (850 °C glow wire resistant)
Housing colour	RAL 7001
Weight	Atlantic LED II S CG-S: 1.4 kg Atlantic LED II D CG-S: 1.8 kg
Type of mounting	Wall- and ceiling mounting
Connection terminals	3 x 2 x 2.5 mm <sup>2</sup>
Connection voltage	220 – 240 V, 50/60 Hz 176 – 275 V DC
Current consumption - battery operation (220 V)	20.0 mA
Power consumption mains operation (apparent power / effective power)	8.0 VA / 3.9 W
Inrush current	1.5 A
Permissible ambient temperature	-20 °C to +40 °C
Light source	1 x 2.2 W High Power LED

Dimensions in mm

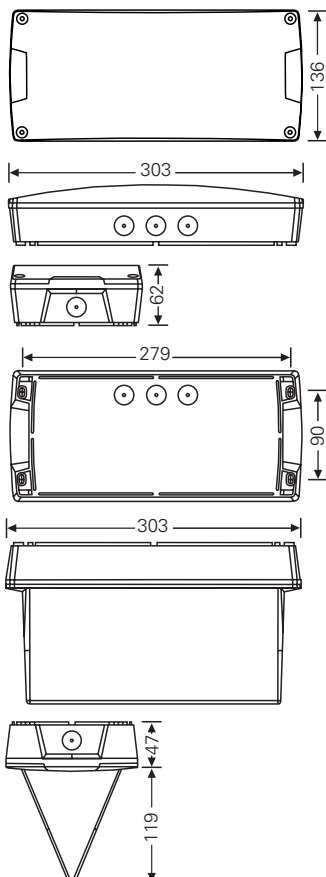

### Ordering details

Type	Scope of supply	Order No.
Atlantic LED II S CG-S	Exit sign luminaire, single sided, IP66 / IK09, without pictogram, CG-S technology (20 addresses) incl. M20 cable gland	40071355601
Atlantic LED II D CG-S	Exit sign luminaire, double sided, IP66 / IK09, without pictograms (2 required), CG-S technology (20 addresses), incl. M20 cable gland	40071355602

### Accessories

Type	Scope of supply	Atlantic LED II S Order No.	Atlantic LED II D Order No.
			<b>2 x required</b>
Arrow right acc. ISO 7010	pictogram	155-000-011	155-000-211
Arrow left acc. ISO 7010	pictogram	155-000-012	155-000-212
Arrow down acc. ISO 7010	pictogram	155-000-013	155-000-213
Arrow up acc. ISO 7010	pictogram	40071355423	40071355453
Blind	Blind (white foil)		155-000-209

# Atlantic LED II HB CG-S

Safety and Exit Sign Luminaires with High Ingress Protection



## Atlantic LED II HB CG-S

- LED safety luminaire with high protection class (IP66) for indoor and outdoor use
- An integrated pressure equalization membrane reduces the effects of condensation in changing weather conditions
- Luminaire with limited surface temperatures for use in operating areas with fire hazard
- Acc. HACCP suitable for use in food processing industry
- Robust construction from aluminium diecast and high impact resistant cover made of polycarbonate
- Numerous knock-outs for cable entries and double terminal for through-wiring
- Suitable for mounting heights up to 32 m by narrow beam optics and exceptionally efficient High Power LEDs
- Spacing up to 28 m from luminaire to luminaire with optics for exit route illumination
- Up to 15 m from luminaire to luminaire with optics for open area illumination.
- Minimum service requirement due to high service life of the LEDs (up to 50.000 hours)
- Shortened inspection effort due to CEWA GUARD technology
- Automatic function monitoring of up to 20 luminaires per circuit
- Reduced installation expenditures by STAR technology
- Freely programmable mixed operation of the switching modes per luminaire in one circuit

Atlantic LED II R HB CG-S



Atlantic LED II O HB CG-S



Dimensions in mm

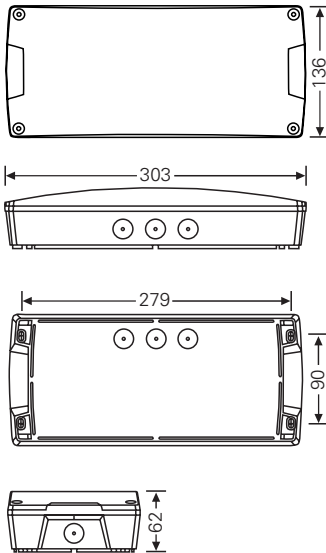

Luminous flux	380 lm
Luminous flux $\Phi_E/\Phi_N$ at the end of rated operating time	100 %
Housing material	Enclosure: Aluminium diecast Cover: Polycarbonate (850 °C glow wire resistant)
Housing colour	RAL 7001
Weight	1.4 kg
Type of mounting	Ceiling mounting
Connection terminals	3 x 2 x 2.5 mm <sup>2</sup>
Connection voltage	220 – 240 V, 50/60 Hz 176 – 275 V DC
Current consumption - battery operation (220 V)	27 mA
Power consumption mains operation (apparent power / effective power)	8.5 VA / 5.0 W
Inrush current	1.5 A
Permissible ambient temperature	-20 °C to +40 °C
Light source	HighPower LEDs 2 x 1.6 W (6000 K / CRI >= 70)

## Ordering details

Type	Scope of supply	Order No.
Atlantic LED II R HB CG-S	Safety luminaire, IP66 / IK09, with asymmetric narrow beam optics for exit route illumination. incl. LED supply and CG-S technology (20 addresses), incl. M20 cable gland	40071355608
Atlantic LED II O HB CG-S	Safety luminaire, IP66 / IK09, with symmetric narrow beam optics for anti-panic / open area illumination, incl. LED supply and CG-S technology (20 addresses), incl. M20 cable gland	40071355607

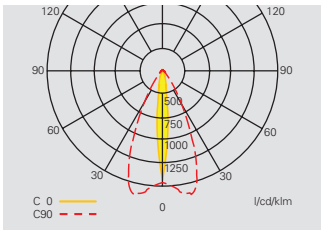

Light distribution curve  
Atlantic LED II R HB CG-S  
with asymmetric optics

### Planning data for Atlantic LED II R HB – Asymmetric optics, for E = 1.0 lx (0.5 lx)

Measuring level 0.02 m, maintenance factor MF = 80 %, battery operation, distances in m

Mounting height [m]	Type of mounting	Lux level directly under	L1	L2	L3	L4
8.0	Ceiling mounting	16.4	6.1 (6.8)	13.6 (15.5)	2.8 (3.5)	6.9 (8.4)
10.0	Escape route	10.5	6.9 (8.0)	15.9 (17.9)	2.9 (3.8)	7.7 (9.1)
12.0	centre	7.3	7.7 (8.9)	17.8 (20.0)	2.9 (4.1)	8.1 (10.1)
14.0		5.4	8.3 (9.7)	19.4 (22.3)	2.6 (4.2)	8.3 (10.8)
16.0		4.1	8.9 (10.6)	21.1 (24.4)	2.6 (4.1)	8.2 (11.3)
18.0		3.2	9.3 (11.3)	22.5 (26.1)	2.7 (4.0)	7.9 (11.7)
20.0		2.6	9.7 (11.8)	23.6 (27.7)	2.6 (3.6)	7.3 (11.8)
22.0		2.2	9.9 (12.4)	24.7 (29.4)	2.4 (3.7)	7.4 (11.6)
24.0		1.8	10.1 (12.9)	25.8 (30.9)	2.1 (3.7)	7.5 (11.5)
26.0		1.6	10.1 (13.3)	26.6 (32.2)	1.8 (3.8)	7.5 (11.1)
28.0		1.3	10.0 (13.6)	27.2 (33.2)	1.4 (3.7)	7.4 (10.4)
30.0		1.2	9.5 (13.9)	27.7 (34.3)	0.9 (3.5)	7.1 (10.3)
32.0		1.0	8.8 (14.1)	28.2 (35.5)	0.2 (3.3)	6.7 (10.5)

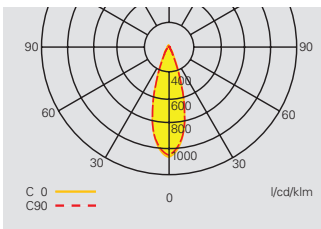

Light distribution curve  
Atlantic LED II O HB CG-S  
with symmetric optics

### Planning data for Atlantic LED II O HB – Symmetric optics, for E = 1.0 lx (0.5 lx)

Measuring level 0.02 m, maintenance factor MF = 80 %, battery operation, distances in m

Mounting height [m]	Type of mounting	Lux level directly under	L1	L2	L3	L4
8.0	Ceiling mounting	13,2	4.1 (4.9)	9.7 (11.8)	4.0 (4.7)	9.3 (11.1)
10.0	Escape route	8,5	4.5 (5.5)	10.9 (13.0)	4.5 (5.4)	10.7 (12.6)
12.0	centre	5,9	5.0 (6.0)	11.9 (14.0)	5.0 (5.9)	11.7 (13.7)
14.0		4,3	5.2 (6.4)	12.8 (15.3)	5.3 (6.3)	12.7 (15.0)
16.0		3,3	5.5 (6.9)	13.7 (16.4)	5.5 (6.8)	13.7 (16.1)
18.0		2,6	5.6 (7.2)	14.4 (17.2)	5.6 (7.2)	14.4 (16.9)
20.0		2,1	5.5 (7.4)	14.8 (18.2)	5.6 (7.5)	14.9 (18.0)
22.0		1,8	5.2 (7.6)	15.3 (19.1)	5.4 (7.7)	15.4 (19.1)
24.0		1,5	4.8 (7.8)	15.6 (19.9)	4.9 (7.9)	15.8 (19.9)
26.0		1,3	3.9 (7.9)	15.7 (20.5)	4.1 (8.0)	15.9 (20.6)
28.0		1,1	2.4 (7.8)	15.6 (20.9)	2.4 (7.9)	15.9 (21.0)
8.0	Ceiling mounting		2.9 (3.2)	7.9 (9.9)	3.2 (3.6)	7.8 (9.8)
10.0	Room illumination		3.3 (3.7)	8.8 (10.7)	3.6 (4.1)	8.7 (10.7)
12.0	Array of		3.4 (4.0)	9.5 (11.5)	3.9 (4.3)	9.5 (11.5)
14.0	2x2 luminaires		3.8 (4.5)	10.3 (12.4)	4.1 (4.8)	10.3 (12.3)
16.0			4.1 (4.7)	10.9 (13.0)	4.5 (5.2)	10.9 (13.0)
18.0			4.2 (4.8)	11.6 (14.0)	4.7 (5.3)	11.5 (13.9)
20.0			4.1 (5.3)	12.3 (14.7)	4.6 (5.7)	12.3 (14.6)
22.0			4.2 (5.6)	12.9 (15.4)	4.7 (6.0)	12.9 (15.2)
24.0			4.2 (5.9)	13.4 (15.8)	4.7 (6.3)	13.4 (15.7)
26.0			4.1 (5.6)	13.8 (16.6)	4.6 (6.4)	13.8 (16.6)
28.0			3.9 (5.5)	14.2 (17.4)	4.3 (6.3)	14.1 (17.3)

# Atlantic LED II CG-S / Outdoor Wall II CG-S

Safety and Exit Sign Luminaires with High Ingress Protection



## Atlantic LED II, Outdoor Wall II CG-S

- LED safety luminaire with high protection class (IP66) for indoor and outdoor use
- An integrated pressure equalization membrane reduces the effects of condensation in changing weather conditions
- Luminaire with limited surface temperatures for use in operating areas with fire hazard
- Acc. HACCP suitable for use in food processing industry (not Outdoor Wall)
- Robust construction from aluminium diecast and high impact resistant cover made of polycarbonate
- Numerous knock-outs for cable entries and double terminal for through-wiring (Outdoor Wall only one cable entry)
- High spacing by double optics technology and highly efficient HighPower LEDs
- Up to 28 m from luminaire to luminaire with optics for exit route illumination
- Minimum service requirement due to high service life of the LEDs (up to 50.000 hours)
- Shortened inspection effort due to CEWA GUARD technology
- Automatic function monitoring of up to 20 luminaires per circuit
- Reduced installation expenditures by STAR technology
- Freely programmable mixed operation of the switching modes per luminaire in one circuit

Atlantic LED II R CG-S



Atlantic LED II O CG-S



Outdoor Wall II CG-S



Luminous flux	Atlantic LED / OutdoorWall R 250 lm Atlantic LED / OutdoorWall O 260 lm
Luminous flux $\Phi_E/\Phi_N$ at the end of rated operating time	100 %
Housing material	Enclosure: Aluminium diecast Cover: Polycarbonate (850 °C glow wire resistant)
Housing colour	RAL 7001
Weight	Atlantic LED II CG-S: 1.4 kg OutdoorWall II CG-S: 2.7 kg
Type of mounting	Wall or ceiling mounting
Connection terminals	3 x 2 x 2.5 mm <sup>2</sup>
Connection voltage	220 – 240 V, 50/60 Hz; 176 – 275 V DC
Current consumption - battery operation (220 V)	20 mA
Power consumption mains operation (apparent power / effective power)	8.0 VA / 3.9W
Inrush current	1.5 A
Permissible ambient temperature	-20 °C to +40 °C
Light source	1 x 2.2W HighPower LED (6000 K / CRI >= 70)

## Ordering details

Type	Scope of supply	Order No.
Atlantic LED II R CG-S	Safety luminaire, IP66 / IK09, with asymmetric optics for exit route illumination, incl. LED supply and CG-S technology (20 addresses), incl. M20 cable gland	40071355603
Atlantic LED II O CG-S	Safety luminaire, IP66 / IK09, with symmetric optics for anti-panic / open area illumination, incl. LED supply and CG-S technology (20 addresses), incl. M20 cable gland	40071355604
Outdoor Wall II R CG-S	Safety luminaire, IP66 / IK09, with asymmetric optics for exit route illumination, incl. LED supply and CG-S technology (20 addresses)	40071355605
Outdoor Wall II O CG-S	Safety luminaire, IP66 / IK09, with symmetric optics for anti-panic / open area illumination, incl. LED supply and CG-S technology (20 addresses)	40071355606

Dimensions in mm

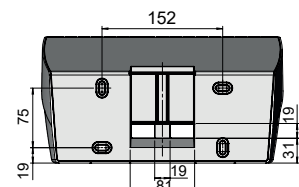
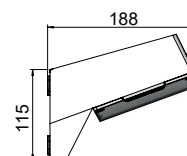
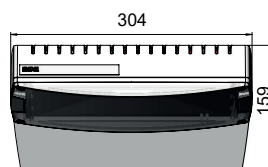
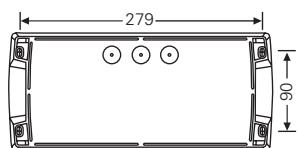
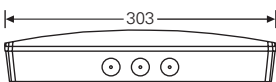

# Atlantic LED II CG-S / Outdoor Wall II CG-S

Safety and Exit Sign Luminaires with High Ingress Protection

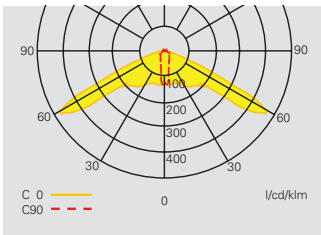

Light distribution curve  
Atlantic LED II R CG-S  
with asymmetric optics

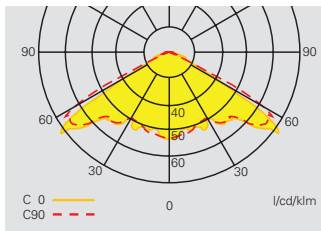

Light distribution curve  
Atlantic LED II O CG-S  
with symmetric optics

## Planning data for Atlantic LED II R CG-S – Asymmetric optics, for E = 1.0 lx (0.5 lx)

Measuring level 0.02 m, maintenance factor MF = 80 %, battery operation, distances in m

Mounting height [m]	Type of mounting	Lux level directly under	L1	L2	L3	L4
2.5	Ceiling mounting	15.3	6.0 (6.6)	13.1 (14.4)	2.5 (3.6)	7.1 (8.0)
3.0	Escape route	10.6	6.9 (7.6)	15.1 (16.3)	2.5 (3.8)	7.4 (9.1)
3.5	centre	7.8	7.6 (8.5)	17.0 (18.5)	2.5 (3.6)	7.2 (10.0)
4.0		6.0	8.3 (9.3)	18.7 (20.5)	2.5 (3.6)	7.2 (10.3)
4.5		4.7	9.1 (10.1)	20.2 (22.4)	2.4 (3.6)	7.2 (10.6)
5.0		3.8	9.7 (10.9)	21.7 (24.2)	2.3 (3.6)	7.1 (10.0)
5.5		3.2	10.3 (11.6)	23.2 (25.9)	2.0 (3.5)	7.0 (10.1)
6.0		2.7	10.9 (12.3)	24.6 (27.5)	1.9 (3.4)	6.8 (10.1)
6.5		2.3	11.4 (13.0)	26.0 (29.0)	1.8 (3.3)	6.7 (10.2)
7.0		2.0	8.3 (13.6)	27.3 (30.5)	1.7 (3.2)	6.4 (10.1)
7.5		1.7	7.5 (14.3)	28.0 (31.9)	1.5 (3.0)	6.0 (10.0)
8.0		1.5	7.0 (14.8)	27.7 (33.4)	1.4 (2.8)	5.6 (9.8)
8.5		1.3	6.5 (15.4)	27.8 (34.8)	1.3 (2.7)	5.4 (9.6)
9.0		1.2	5.7 (16.0)	28.0 (36.2)	1.2 (2.5)	5.1 (9.5)
9.5		1.1	3.9 (16.5)	28.4 (37.6)	1.1 (2.4)	4.9 (9.3)

## Planning data for Atlantic LED II O CG-S – Symmetric optics, for E = 1.0 lx (0.5 lx)

Measuring level 0.02 m, maintenance factor MF = 80 %, battery operation, distances in m

Mounting height [m]	Type of mounting	Lux level directly under	L1	L2	L3	L4
2.5	Ceiling mounting	6.7	4.0 (4.3)	8.6 (9.6)	4.3 (4.7)	9.5 (10.1)
3.0	Escape route	4.7	4.5 (5.0)	9.9 (10.9)	4.6 (5.5)	10.9 (11.8)
3.5	centre	3.4	4.9 (5.6)	11.1 (12.1)	4.7 (6.1)	12.0 (13.3)
4.0		2.6	4.5 (6.1)	12.2 (13.5)	4.0 (6.4)	12.8 (14.8)
4.5		2.1	3.7 (6.6)	12.5 (14.7)	3.7 (6.6)	12.7 (16.1)
5.0		1.7	2.8 (6.9)	12.8 (15.9)	2.8 (6.6)	12.6 (17.1)
5.5		1.4	2.6 (6.7)	12.6 (17.0)	2.2 (6.3)	12.1 (17.9)
6.0		1.2	1.5 (5.5)	11.1 (18.0)	1.6 (5.4)	10.9 (17.8)
2.5	Ceiling mounting		4.4 (4.8)	8.6 (9.2)	4.5 (3.0)	8.9 (9.5)
3.0	Room illumination		4.8 (5.3)	9.9 (10.8)	5.0 (3.5)	10.3 (11.2)
3.5	Array of		5.1 (6.0)	11.1 (12.1)	5.2 (6.1)	11.5 (12.5)
4.0	2x2 luminaires		4.5 (6.4)	12.2 (13.4)	4.6 (6.6)	12.6 (13.9)
4.5			3.9 (6.9)	12.1 (14.7)	3.5 (7.0)	12.5 (15.2)
5.0			2.6 (7.2)	12.4 (15.8)	2.2 (7.1)	12.8 (16.3)
5.5			2.6 (7.0)	12.1 (16.9)	1.2 (6.6)	12.2 (17.5)
6.0			2.1 (5.4)	11.4 (17.7)	2.5 (3.7)	11.4 (18.0)

# Atlantic LED II CG-S / Outdoor Wall II CG-S

Safety and Exit Sign Luminaires with High Ingress Protection

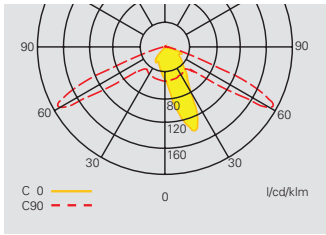

Light distribution curve  
Outdoor Wall II R CG-S  
with asymmetric optics

## Planning help for Outdoor Wall II R CG-S – Asymmetric optics, for E = 1.0 lx

Measuring level 0.02 m, maintenance factor MF = 80 %, battery operation, distances in m

Mounting height [m]	Type of mounting	L1	L2	D
2.0	Wall mounting	5.6	12.4	0.5- 2.2
2.5		6.2	13.5	0.5- 2.3
3.0		6.9	15.2	0.5- 2.5
3.5		7.4	16.8	0.5- 2.7
4.0		7.8	18.3	0.5- 2.8
4.5		8.2	19.6	0.5- 2.9
5.0		8.0	19.9	0.5- 2.9
5.5		3.6	18.1	0.5- 3.5
6.0		2.5	17.9	0.5- 3.6

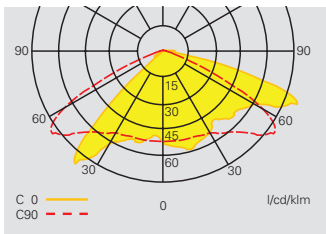
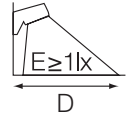

Light distribution curve  
Outdoor Wall II O CG-S  
with symmetric optics

## Planning help for Outdoor Wall II O CG-S – Symmetric optics for E = 1.0 lx

Measuring level 0.02 m, maintenance factor MF = 80 %, battery operation, distances in m

Mounting height [m]	Type of mounting	L1	D1	D <sub>max</sub>
2,2	Wall mounting	3,8	3,6	4,5
2,5		3,9	3,4	4,3
3,0		3,8	2,9	4,1
3,5		3,1	3,2	3,8
4,0		2,9	2,7	3,7
4,5		2,5	2,5	3,3
5,0		2,1	2,2	3,0

