

TARA Showerpipe without hand shower FlowReduce 220 mm - Brushed Platinum

TARA

26 633 892 Product version from 4/1/2024



Rain shower:

- rain shower Ø 220 mm
- Rain shower material: metal
- Rain shower: PURE RAIN, max. flow rate 7 l/min (at 3 bar)
- Function from: 4 l/min
- rain shower with anti-scale system

Control element:

- rotary diverter for fixed-riser shower/hand shower
- slide-on rosettes Ø 57 mm
- 1500 mm metal shower hose

Technical data:

- shower with fixed riser projection 420mm
- height of fittings up to rain shower (bottom edge) 1007mm
- height of fittings up to top edge of elbow 1167mm
- rosette for wall mounting Ø 57mm
- rosette for shower holder Ø 55mm
- rosette for shower mixer Ø 65mm
- Pipe diameter 20 mm
- gauge 150 mm - 13 mm

Notes:

- This product can help a building meet the requirements of Green Building Rating Systems, e.g. LEED®, BREEAM®, DGNB

This article does not include a hand shower!

Intrinsic protection against back flow.

| | | |
|---|-------------------------------|---------------|
|  | Brushed Platinum | 26 633 892-06 |
|  | Chrome | 26 633 892-00 |
|  | Platinum | 26 633 892-08 |
|  | Dark Chrome | 26 633 892-19 |
|  | Brushed Durabrass (23kt Gold) | 26 633 892-28 |
|  | Matte Black | 26 633 892-33 |
|  | Brushed Gold (PVD) | 26 633 892-37 |
|  | Brushed Dark Brass (PVD) | 26 633 892-39 |
|  | Brushed Bronze (PVD) | 26 633 892-42 |
|  | Brushed Dark Bronze (PVD) | 26 633 892-43 |
|  | Brushed Champagne (22kt Gold) | 26 633 892-46 |
|  | Champagne (22kt Gold) | 26 633 892-47 |
|  | Brushed Chrome | 26 633 892-93 |
|  | Brushed Dark Platinum | 26 633 892-99 |

TARA Showerpipe without hand shower FlowReduce 220 mm - Brushed Platinum

TARA

26 633 892 Product version from 4/1/2024

Required miscellaneous

| | | |
|---|---|-----------------------|
|  | Hand shower FlowReduce 120 mm - Brushed Platinum | 28 012 979-06 0010 |
|---|---|-----------------------|

Required miscellaneous

| | | |
|---|---------------------------------------|---------------|
|  | Hand shower - Brushed Platinum | 28 015 979-06 |
|---|---------------------------------------|---------------|

Required miscellaneous

| | | |
|---|---|-----------------------|
|  | SERIES-VARIOUS Hand shower FlowReduce - Brushed Platinum | 28 027 979-06 0010 |
|---|---|-----------------------|

Required miscellaneous

| | | |
|---|--|---------------|
|  | Hand shower 100 mm - Brushed Platinum | 28 018 979-06 |
|---|--|---------------|

Required miscellaneous

| | | |
|---|---|-----------------------|
|  | SERIES-VARIOUS Hand shower FlowReduce - Brushed Platinum | 28 029 979-06 0010 |
|---|---|-----------------------|

Required miscellaneous

| | | |
|---|---|-----------------------|
|  | Hand shower FlowReduce 130 mm - Brushed Platinum | 28 016 979-06 0010 |
|---|---|-----------------------|

Required miscellaneous

| | | |
|---|--|---------------|
|  | Hand shower 120 mm - Brushed Platinum | 28 012 979-06 |
|---|--|---------------|

Required miscellaneous

| | | |
|---|---|-----------------------|
|  | SERIES-VARIOUS Hand shower FlowReduce - Brushed Platinum | 28 025 979-06 0010 |
|---|---|-----------------------|

Required miscellaneous

| | | |
|---|---------------------------------------|---------------|
|  | Hand shower - Brushed Platinum | 28 017 979-06 |
|---|---------------------------------------|---------------|

Required miscellaneous

| | | |
|---|---|-----------------------|
|  | Hand shower FlowReduce 100 mm - Brushed Platinum | 28 018 979-06 0010 |
|---|---|-----------------------|

Required miscellaneous

| | | |
|---|--|---------------|
|  | Hand shower 130 mm - Brushed Platinum | 28 016 979-06 |
|---|--|---------------|

26 633 892 Product version from 4/1/2024
mm [inches]
1:10

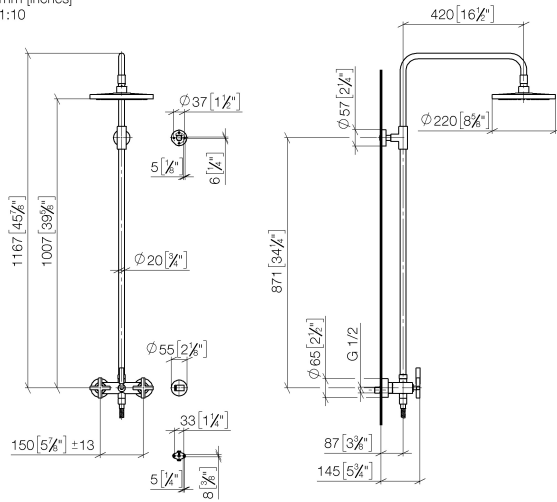

Flow rate chart

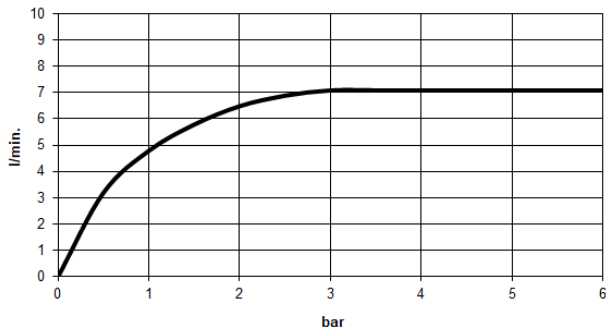

Codes & Standards

DIN 4109

EN 1717

ISO 3822

Scottish Water
Byelaws

UK Water Supply
Regulations

Ü-Zeichen



TARA Showerpipe without hand shower FlowReduce 220 mm - Brushed
Platinum

TARA

26 633 892 Product version from 4/1/2024

Certificates and sustainability

Belgaqua_21-023-2 WRAS_2204

LGA_38

EPD-DOR-20230287 Belgaqua_25-345-2
-IBA1-EN
Environmental.prod
uct-declarat

TARA Showerpipe without hand shower FlowReduce 220 mm - Brushed Platinum

TARA

26 633 892 Product version from 4/1/2024

Parts for other finishes can be found here: [Chrome](#)

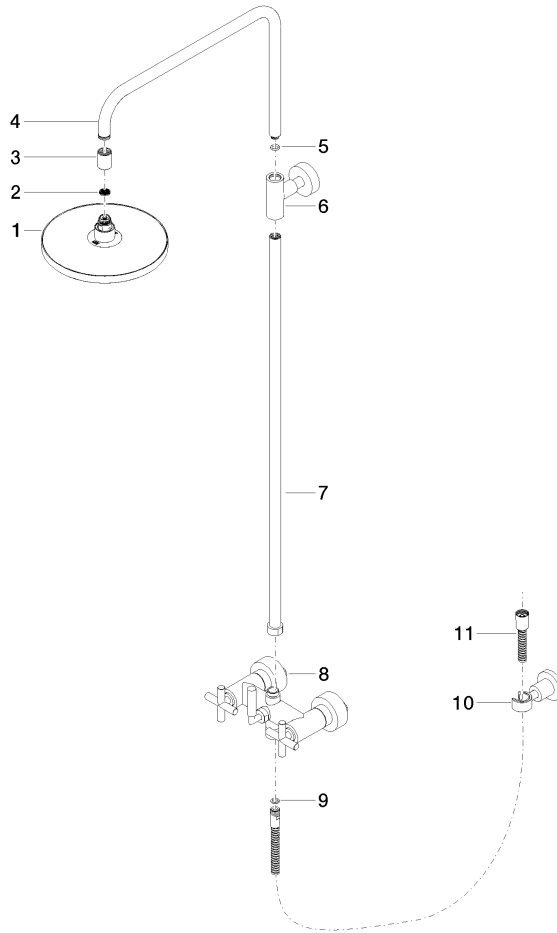

Spare parts list

| No. | Item Number | Name | Quantity used | Delivery time |
|-----|--------------------|---|---------------|---------------|
| 8 | 04 17 10 020 01-06 | Connection for bath wall-mounting 200 x 215 x 140 mm - Brushed Platinum | 1.00 | 20 |
| 11 | 28 304 970-06 | Metal shower hose 1/2" x 3/8" x 1500 mm - Brushed Platinum | 1.00 | 14 |
| 6 | 90 17 11 037 00-06 | Mounting for spray deck mounting T-piece - Brushed Platinum | 1.00 | 20 |
| 1 | 90 12 05 092 20-06 | Rainshower round Ø 220 mm - Brushed Platinum | 1.00 | 20 |
| 4 | 04 28 22 101 20-06 | Spout 447,5 x 30 x 297 mm - Brushed Platinum | 1.00 | 20 |
| 10 | 28 050 892-06 | TARA Wall bracket - Brushed Platinum | 1.00 | 20 |
| 7 | 90 28 22 096 00-06 | Pipe 830 mm - Brushed Platinum | 1.00 | 20 |
| 3 | 09 24 03 177 20-06 | Connection Adapter for rain shower Ø 25 x 30 mm - Brushed Platinum | 1.00 | 20 |
| 2 | 09 23 01 039 90 | Sieve seal Ø 19 x 5,5 mm - | 1.00 | 14 |
| 9 | 90 14 20 026 00 90 | Washer 14 x 8 x 2 mm Centellen WS 3820 - | 1.00 | 14 |
| 5 | 90 14 10 011 00 90 | O-Ring EPDM 70 11,0 x 2,5 mm - | 1.00 | 14 |