

Color: ■ gray

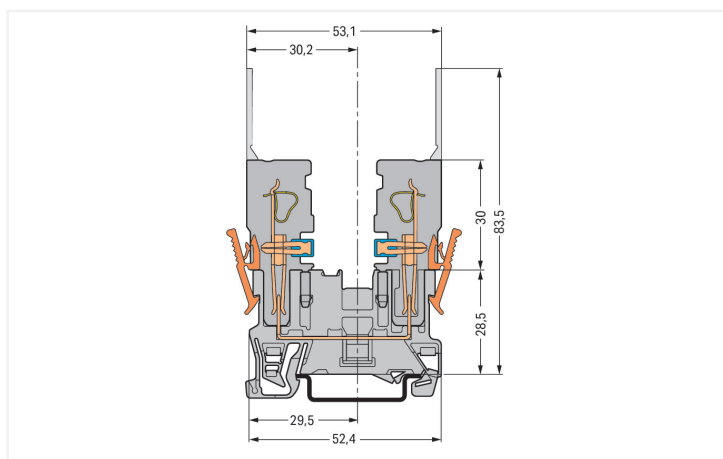

Carrier terminal block

Through terminal block, 769 Series, gray

Our through terminal block (item number 769-156) makes connecting wires quick and easy. Whether in industrial or building applications, our rail-mount through terminal blocks are the perfect solution to quickly and securely connect electrical conductors. Depending on the variant, you can use them for either typical through-wiring or potential distribution.

Notes

Safety Information

A separator plate (Item No. 209-191) or a 10 mm end stop (Item No. 249-117) must be placed at the end of a WAGO X-COM®-SYSTEM terminal strip.

Safety information 2

Staggered jumpers cannot be installed in terminal blocks when using 2-conductor female plugs.

Electrical data

Ratings per	IEC/EN 60947-7-1		
	III	III	II
Overvoltage category	III	III	II
Pollution degree	3	2	2
Nominal voltage	500 V	-	-
Rated impulse withstand voltage	6 kV	-	-
Rated current	32 A	-	-

Power Loss

Rated current I_N for power loss specification 32 A

General information

Wiring direction Front-entry wiring

Connection Data

Total number of potentials	1
Number of levels	1

Connection 1

Wiring direction Front-entry wiring

Physical data

Width	5 mm / 0.197 inches
Height	52.5 mm / 2.067 inches
Depth from upper-edge of DIN-rail	28.5 mm / 1.122 inches

Mechanical data

Design	horizontal type
Mounting type	DIN-35 rail
Marking level	Center marking

Material data

Note (material data)	Information on material specifications can be found here
Color	gray
Material group	I
Insulation material (main housing)	Polyamide (PA66)
Flammability class per UL94	V0
Fire load	0.099 MJ
Weight	4.5 g

Environmental requirements

Processing temperature	-35 ... +85 °C
Continuous operating temperature	-60 ... +105 °C

Commercial data

Product Group	18 (X-COM-System)
PU (SPU)	100 pcs
Packaging type	Box
Country of origin	DE
GTIN	4044918391672
Customs tariff number	85366990990

Product Classification

UNSPSC	39121410
eCl@ss 10.0	27-14-11-20
eCl@ss 9.0	27-14-11-20
ETIM 9.0	EC000897
ETIM 10.0	EC000897
ECCN	NO US CLASSIFICATION

Environmental Product Compliance

RoHS Compliance Status	Compliant, No Exemption
------------------------	-------------------------

Approvals / Certificates

General approvals



Approval	Standard	Certificate Name
CCA DEKRA Certification B.V.	EN 60947	NTR NL-7626
CSA CSA Group	C22.2	1101144
KEMA/KEUR DEKRA Certification B.V.	EN 60947	2190419.01
UL Underwriters Laboratories Inc.	UL 1059	E45172
UL Underwriters Laboratories Inc.	UL 1977	E 45171

Declarations of conformity and manufacturer's declarations



Approval	Standard	Certificate Name
EU-Declaration of Conformity WAGO GmbH & Co. KG	-	-
Railway WAGO GmbH & Co. KG	-	Z00004428.000

Approvals for marine applications



Approval	Standard	Certificate Name
ABS American Bureau of Shipping	EN 60947	24-0152298-PDA
DNV GL Det Norske Veritas, Germanischer Lloyd	-	TAE00001V2
PRS Polski Rejestr Statków	-	TE/1094/880590/23

Downloads

Environmental Product Compliance

Compliance Search

Environmental Product Compliance 769-156



Documentation

Bid Text

769-156	19.02.2019	xml 2.93 KB	
769-156	02.10.2017	doc 24.00 KB	

CAD/CAE-Data

CAD data

2D/3D Models 769-156



CAE data

EPLAN Data Portal
769-156



WSCAD Universe
769-156



ZUKEN Portal 769-156



1 Compatible Products

1.1 System counterpart

1.1.1 Female connector/socket



[Item No.: 769-101/022-000](#)

1-conductor female connector, angled; CAGE CLAMP®; 4 mm²; Pin spacing 5 mm; 1-pole; coding finger; 4,00 mm²; gray



[Item No.: 769-110/145-000](#)

1-conductor female connector; CAGE CLAMP®; 4 mm²; Pin spacing 5 mm; 10-pole; coding finger; Centered locking levers; Strain relief plate; 4,00 mm²; gray



[Item No.: 769-111/145-000](#)

1-conductor female connector; CAGE CLAMP®; 4 mm²; Pin spacing 5 mm; 11-pole; coding finger; Centered locking levers; Strain relief plate; 4,00 mm²; gray



[Item No.: 769-112/145-000](#)

1-conductor female connector; CAGE CLAMP®; 4 mm²; Pin spacing 5 mm; 12-pole; coding finger; Centered locking levers; Strain relief plate; 4,00 mm²; gray



[Item No.: 769-113/145-000](#)

1-conductor female connector; CAGE CLAMP®; 4 mm²; Pin spacing 5 mm; 13-pole; coding finger; Centered locking levers; Strain relief plate; 4,00 mm²; gray



[Item No.: 769-114/145-000](#)

1-conductor female connector; CAGE CLAMP®; 4 mm²; Pin spacing 5 mm; 14-pole; coding finger; Centered locking levers; Strain relief plate; 4,00 mm²; gray



[Item No.: 769-115/145-000](#)

1-conductor female connector; CAGE CLAMP®; 4 mm²; Pin spacing 5 mm; 15-pole; coding finger; Centered locking levers; Strain relief plate; 4,00 mm²; gray



[Item No.: 769-101](#)

1-conductor female connector; CAGE CLAMP®; 4 mm²; Pin spacing 5 mm; 1-pole; coding finger; 4,00 mm²; gray



[Item No.: 769-101/141-000](#)

1-conductor female connector; CAGE CLAMP®; 4 mm²; Pin spacing 5 mm; 1-pole; coding finger; Centered locking levers; Strain relief plate; 4,00 mm²; gray



[Item No.: 769-102/142-000](#)

1-conductor female connector; CAGE CLAMP®; 4 mm²; Pin spacing 5 mm; 2-pole; coding finger; Centered locking levers; Strain relief plate; 4,00 mm²; gray



[Item No.: 769-103/142-000](#)

1-conductor female connector; CAGE CLAMP®; 4 mm²; Pin spacing 5 mm; 3-pole; coding finger; Centered locking levers; Strain relief plate; 4,00 mm²; gray



[Item No.: 769-104/143-000](#)

1-conductor female connector; CAGE CLAMP®; 4 mm²; Pin spacing 5 mm; 4-pole; coding finger; Centered locking levers; Strain relief plate; 4,00 mm²; gray



[Item No.: 769-105/143-000](#)

1-conductor female connector; CAGE CLAMP®; 4 mm²; Pin spacing 5 mm; 5-pole; coding finger; Centered locking levers; Strain relief plate; 4,00 mm²; gray



[Item No.: 769-106/144-000](#)

1-conductor female connector; CAGE CLAMP®; 4 mm²; Pin spacing 5 mm; 6-pole; coding finger; Centered locking levers; Strain relief plate; 4,00 mm²; gray



[Item No.: 769-107/144-000](#)

1-conductor female connector; CAGE CLAMP®; 4 mm²; Pin spacing 5 mm; 7-pole; coding finger; Centered locking levers; Strain relief plate; 4,00 mm²; gray



[Item No.: 769-108/144-000](#)

1-conductor female connector; CAGE CLAMP®; 4 mm²; Pin spacing 5 mm; 8-pole; coding finger; Centered locking levers; Strain relief plate; 4,00 mm²; gray

1.1.1 Female connector/socket



Item No.: 769-109/144-000
 1-conductor female connector; CAGE CLAMP®; 4 mm²; Pin spacing 5 mm; 9-pole; coding finger; Centered locking levers; Strain relief plate; 4,00 mm²; gray

Item No.: 769-121
 2-conductor female connector; CAGE CLAMP®; 4 mm²; Pin spacing 5 mm; 1-pole; coding finger; 4,00 mm²; gray

1.2 Required Accessories

1.2.1 End plate

1.2.1.1 End plate



Item No.: 769-305
 End and intermediate plate; 1.1 mm thick; gray

Item No.: 769-306
 End and intermediate plate; 1.1 mm thick; orange

1.3 Optional Accessories

1.3.1 Coding

1.3.1.1 Coding



Item No.: 769-435
 Coding pin; for coding of female plugs; for carrier terminal blocks / male connectors; orange

1.3.2 Cover

1.3.2.1 Cover



Item No.: 769-438
 Pin cover; with marker slot for miniature WSB; gray

Item No.: 769-439
 Pin cover; with marker slot for miniature WSB; orange

1.3.3 DIN-rail

1.3.3.1 Mounting accessories



Item No.: 210-196
 Aluminum carrier rail; 35 x 8.2 mm; 1.6 mm thick; 2 m long; unslotted; similar to EN 60715; silver-colored

Item No.: 210-198
 Copper carrier rail; 35 x 15 mm; 2.3 mm thick; 2 m long; unslotted; according to EN 60715; copper-colored

Item No.: 210-508
 Steel carrier rail; 35 x 15 mm; 1.5 mm thick; 2 m long; slotted; galvanized; similar to EN 60715; silver-colored

Item No.: 210-197
 Steel carrier rail; 35 x 15 mm; 1.5 mm thick; 2 m long; slotted; similar to EN 60715; silver-colored



Item No.: 210-506
 Steel carrier rail; 35 x 15 mm; 1.5 mm thick; 2 m long; unslotted; galvanized; similar to EN 60715; silver-colored

Item No.: 210-114
 Steel carrier rail; 35 x 15 mm; 1.5 mm thick; 2 m long; unslotted; similar to EN 60715; silver-colored

Item No.: 210-118
 Steel carrier rail; 35 x 15 mm; 2.3 mm thick; 2 m long; unslotted; according to EN 60715; silver-colored

Item No.: 210-115
 Steel carrier rail; 35 x 7.5 mm; 1 mm thick; 2 m long; slotted; according to EN 60715; "Hole width 18 mm; silver-colored

1.3.3.1 Mounting accessories



Item No.: 210-112

Steel carrier rail; 35 x 7.5 mm; 1 mm thick; 2 m long; slotted; according to EN 60715; Hole width 25 mm; silver-colored



Item No.: 210-504

Steel carrier rail; 35 x 7.5 mm; 1 mm thick; 2 m long; slotted; galvanized; according to EN 60715; silver-colored



Item No.: 210-113

Steel carrier rail; 35 x 7.5 mm; 1 mm thick; 2 m long; unslotted; according to EN 60715; silver-colored



Item No.: 210-505

Steel carrier rail; 35 x 7.5 mm; 1 mm thick; 2 m long; unslotted; galvanized; according to EN 60715; silver-colored

1.3.4 Installation

1.3.4.1 Mounting accessories



Item No.: 209-106

Mounting carrier; for isolated mounting on DIN 35 rails; gray



Item No.: 249-116

Screwless end stop; 6 mm wide; for DIN-rail 35 x 15 and 35 x 7.5; gray

1.3.5 Jumper

1.3.5.1 Jumper



Item No.: 280-402

Jumper; insulated; gray



Item No.: 280-409

Jumper; insulated; gray



Item No.: 780-452

Staggered jumper; from 1 to 2; insulated; gray



Item No.: 780-453

Staggered jumper; from 1 to 3; insulated; gray



Item No.: 780-454

Staggered jumper; from 1 to 4; insulated; gray



Item No.: 780-455

Staggered jumper; from 1 to 5; insulated; gray



Item No.: 780-456

Staggered jumper; from 1 to 6; insulated; gray



Item No.: 780-457

Staggered jumper; from 1 to 7; insulated; gray



Item No.: 780-458

Staggered jumper; from 1 to 8; insulated; gray

1.3.6 Marking

1.3.6.1 Marker



Item No.: 2009-145

Mini-WSB InLine; for Smart Printer; 1700 pieces on roll; stretchable 5 - 5.2 mm; plain; snap-on type; white



Item No.: 248-501

Mini-WSB marking card; as card; not stretchable; plain; snap-on type; white

1.3.7 Push-in type wire jumper

1.3.7.1 Jumper



Item No.: 249-126

Push-in type wire jumper; 0.75 mm²; insulated; 110 mm long; black



Item No.: 249-123

Push-in type wire jumper; 0.75 mm²; insulated; 180 mm long; black



Item No.: 249-127

Push-in type wire jumper; 0.75 mm²; insulated; 250 mm long; black



Item No.: 249-125

Push-in type wire jumper; insulated; 60 mm long; black

1.3.8 Test and measurement

1.3.8.1 Testing accessories



Item No.: 280-419

Spacer module; modular; bridging commoned terminal blocks; gray



Item No.: 280-404

Test plug adapter; 5 mm wide; for test plug (2.3 mm Ø); suitable for 1.5 mm² - 4 mm² tbs; gray



Item No.: 280-418

Test plug module; modular; suitable for all WAGO 280 and 780 Series rail-mounted terminal blocks with jumper slots in the current bar; gray

1.3.9 Tool

1.3.9.1 Operating tool



Item No.: 210-720

Operating tool; Blade: 3.5 x 0.5 mm; with a partially insulated shaft; multicoloured

Installation Notes

Installation

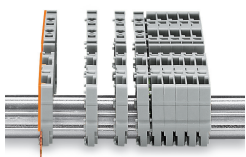

Snap individual carrier terminal blocks onto the DIN-rail and slide together.

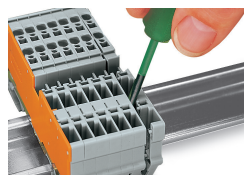

Open the assembly by laterally sliding a block via operating tool and remove terminal block via release lever.

Commoning

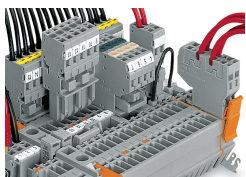

Commoning with adjacent or staggered jumpers. Push jumpers down until fully inserted.

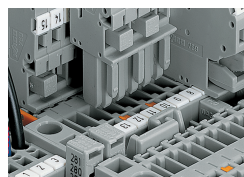

Commoning carrier terminal blocks via staggered jumpers.

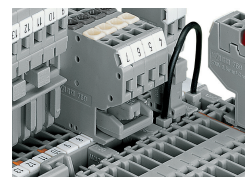

Commoning a 2-conductor female plug via staggered jumper and carrier terminal blocks via adjacent jumpers.

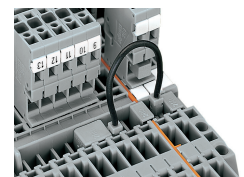

Commoning carrier terminal blocks via push-in type wire jumpers or adjacent jumpers – even over an intermediate plate.

Commoning

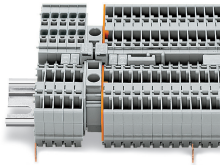

Commoning "supply terminal blocks" (up to 10 mm²/8 AWG) with carrier terminal blocks via step-down jumpers.

Coding

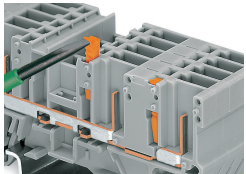

Snap coding pin in proper direction on carrier terminal block.
Shown: Coding pin removal from carrier terminal block.

Locking system

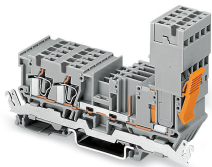

Securing a female plug via locking lever on the terminal block side.

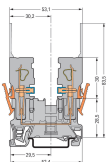

Carrier terminal block



1-conductor female plugs
Carrier terminal blocks can be commoned via 280 and 780 Series Jumpers and tested using a test plug adapter (280-4..).



1-conductor female plug and 2-conductor female plug
Carrier terminal blocks can only be commoned via 280 Series Adjacent and Alternate Jumpers.



2-conductor female plug and 1-conductor female plug
Carrier terminal blocks can be commoned via 280 and 780 Series Jumpers.