

















33 525 660 Product version up to 1/23/2020



- 105mm projection
- fixed spout
- circular, air-enriched flow
- height of mixer 138 mm
- height up to aerator 57 mm
- hole diameter 35 mm
- rosette Ø 50 mm optional
- 2x screw-in M 8 x 1 pressure hose, leak-tested
- max. flow 5.7 l/min
- lead-free
- This product can help a building meet the requirements of Green Building Rating Systems, e.g. LEED®, BREEAM®, DGNB
- WRAS

	Matte Black	33 525 660-33
	Chrome	33 525 660-00
	Brushed Platinum	33 525 660-06
	Platinum	33 525 660-08
	Dark Chrome	33 525 660-19
	Light Gold (PVD)	33 525 660-26
	Brushed Light Gold (PVD)	33 525 660-27
	Red	33 525 660-29
	Orange	33 525 660-30
	Dark Green	33 525 660-31
	Brushed Gold (PVD)	33 525 660-37
	Brushed Dark Brass (PVD)	33 525 660-39
	Brushed Bronze (PVD)	33 525 660-42
	Brushed Dark Bronze (PVD)	33 525 660-43
	Brushed Chrome	33 525 660-93
	Brushed Dark Platinum	33 525 660-99

33 525 660 Product version up to 1/23/2020

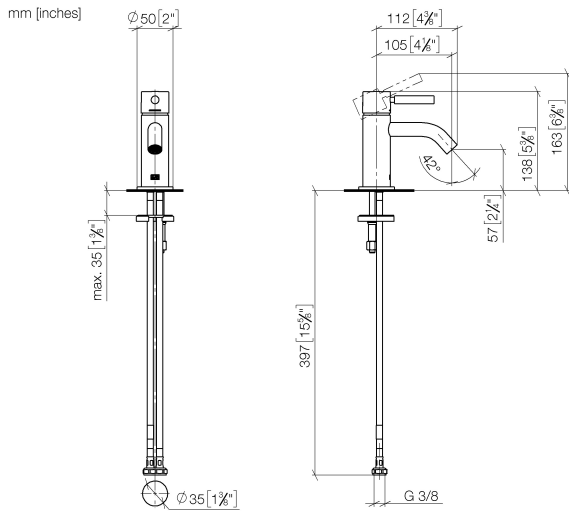

Flow rate chart



Codes & Standards

DIN 4109

EN 817

ISO 3822

Scottish Water
Byelaws

UK Water Supply
Regulations

Ü-Zeichen



META Single-lever basin mixer without pop-up waste - Matte Black

META

33 525 660 Product version up to 1/23/2020

Certificates and sustainability

DVGW_DW-
6506DN0

LGA_29

EPD-DOR-20230287 WRAS_251102
-IBA1-EN
Environmental.prod
uct-declarat

33 525 660 Product version up to 1/23/2020

Parts for other finishes can be found here: [Chrome](#)

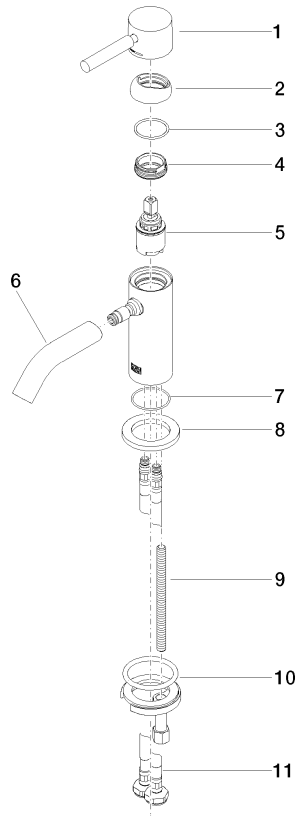

Spare parts list

No.	Item Number	Name	Quantity used	Delivery time
	11 04 30 04 100 00 90	High pressure hose M8x1 x 3/8" x 420 mm -	2.00	14
	9 09 31 11 012 90	Mounting Threaded bolt M8 x110 mm -	1.00	14
	3 09 14 10 120 90	O-Ring NBR 885 26,7 x 1,78 mm -	1.00	14
	6 90 11 06 212 00-33	Spout 90 x 145 x 35 mm, 5,68 l/min. - Matte Black	1.00	40
	7 09 14 10 202 90	O-Ring EPDM 70 31,0 x 1,5 mm -	1.00	14
	4 09 24 04 266 90	Mounting Ø 28 x 10,8 mm -	1.00	14
	2 09 28 30 043-33	Cover Ø 35,7 x 13 mm - Matte Black	1.00	40
	5 90 15 05 044 00 90	Cartridge Ø 25 x 51 mm -	1.00	14
	10 04 30 11 038 00 90	Mounting with O-ring Ø40 x 4mm Ø 52 x 1,5 mm -	1.00	14
	8 09 27 66 006-33	Rosette Ø 50 x Ø 33m x 5 mm - Matte Black	1.00	40
	1 90 20 66 009 00-33	Handle for washstand deck mounting Lever 39 x 30 x 100 mm - Matte Black	1.00	40