









20 713 661 Product version from 7/1/2023



- 168mm projection
- pivotable spout 360°
- circular, air-enriched flow
- height of mixer 280 mm
- height up to aerator 191 mm
- hole diameter valve 32 mm
- hole diameter spout 35 mm
- rosette Ø 60 mm
- 2x screw-in M 8 x 1 pressure hose, leak-tested
- max. flow 5.7 l/min
- lead-free
- This product can help a building meet the requirements of Green Building Rating Systems, e.g. LEED®, BREEAM®, DGNB
- WRAS

Only suitable for basins with an overflow.

	Brushed Platinum	20 713 661-06
	Chrome	20 713 661-00
	Dark Chrome	20 713 661-19
	Light Gold (PVD)	20 713 661-26
	Brushed Light Gold (PVD)	20 713 661-27
	Matte Black	20 713 661-33
	Brushed Gold (PVD)	20 713 661-37
	Brushed Dark Brass (PVD)	20 713 661-39
	Brushed Bronze (PVD)	20 713 661-42
	Brushed Dark Bronze (PVD)	20 713 661-43
	Brushed Chrome	20 713 661-93
	Brushed Dark Platinum	20 713 661-99

Recommended miscellaneous



High pressure hoses -
 • 2x 3/8" x 1/2" x 500mm high pressure hose

12 506 970 90

20 713 661 Product version from 7/1/2023

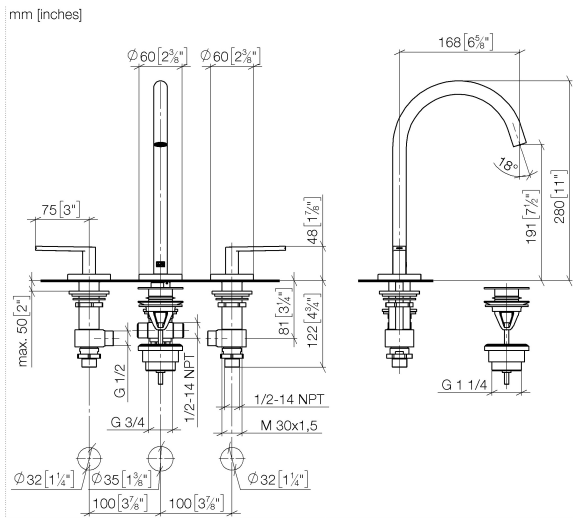

Flow rate chart



Codes & Standards

DIN 4109

EN 200

ISO 3822

Scottish Water
Byelaws

UK Water Supply
Regulations

Ü-Zeichen



META Three-hole basin mixer with pop-up waste - Brushed Platinum

META

20 713 661 Product version from 7/1/2023

Certificates and sustainability

DVGW_DW-
6501DN0

LGA_29

WRAS_250502

EPD-DOR-20230287
-IBA1-EN
Environmental.prod
uct-declarat

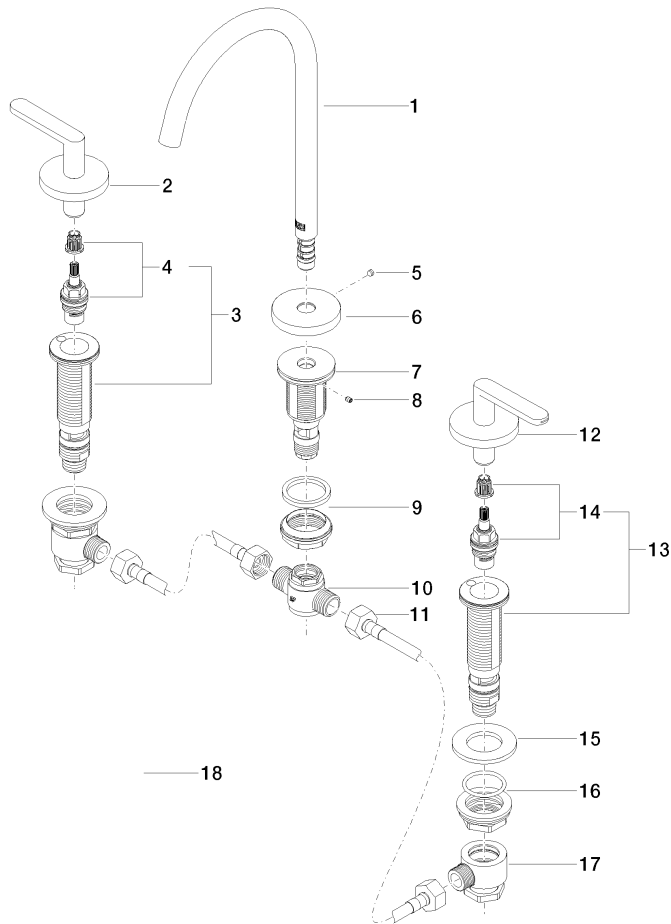

Spare parts list

No.	Item Number	Name	Quantity used	Delivery time
1	90 28 22 325 00-06	Spout for washstand deck mounting 168 mm, 5,68 l/min. - Brushed Platinum	1.00	20
16	04 23 10 032 78 90	Mounting with seals M30 x 1,5 -	2.00	14
8	09 31 11 044 90	Mounting Threaded pin with hexagon socket with cup point M4 x 5 mm -	1.00	14
18	10 125 970-06	Basin Waste with push fastening 1 1/4" - Brushed Platinum	1.00	14
10	90 17 11 020 10 90	Distributor complete -	1.00	14
7	09 30 01 287 90	Connection Ø 50 x 97 mm -	1.00	-
Spare part can no longer be ordered, please order the replacement item				
12	90 20 66 015 00-06	Handle Cold Lever Ø 60 x 105 x 40 mm - Brushed Platinum	1.00	20
15	09 30 11 099 90	Washer Ø 31 -	2.00	14
6	09 27 66 002-06	Rosette Ø 60 x 9 x 15,2 mm - Brushed Platinum	1.00	20
17	04 17 11 023 10 90	Connection Distributor, complete 1/2" -	2.00	14
11	04 30 04 096 00 90	High pressure hose with sleeve nut 1/2" x 1/2" x 400 mm -	2.00	14
5	09 31 11 112 90	Mounting Threaded pin with hexagon socket with point M5 x 6 mm -	1.00	-
Spare part can no longer be ordered, please order the replacement item				
	043111120090	Mounting Threaded pin M5 x 6 mm -		
2	90 20 66 016 00-06	Handle Hot Lever Ø 60 x 105 x 40 mm - Brushed Platinum	1.00	20
9	04 23 10 044 07 90	Attachment set with seals M34 x 1 -	1.00	14
13	04 17 11 058 53 90	Side piece clockwise closing 1/2" -	1.00	14
14	90 90 03 153 00 90	Head part clockwise closing extended, 7mm 1/2" -	1.00	14
4	90 90 03 152 00 90	Head part anti-clockwise closing extended, 7mm 1/2" -	1.00	14
3	04 17 11 058 52 90	Side piece 1/2" -	1.00	14