

# Product data sheet Spirotech

## Product name

**ETCM Duo-9.4 max 23,5bar Twin**

## Product properties

The TopControl Modular DUO Twin is an automatic expansion and pressure-maintaining device. The unit contains 2 VFD pumps (2x 50%) and 2 electronically controlled overflow valves. An unpressurised expansion tank is required.

- 2 VFD pumps (2x 50%)
- 2 electronically controlled overflow valves (2x 100%)
- At least 1 unpressurised expansion vessel needs to be added
- Operational pressure range up to 8.4 to 23.5 bar
- The maximum temperature at the point of connection: 70°C (over 70°C possible with auxiliary tank)
- Maximum safety temperature in the system: 110°C
- Maximum operating pressure (PN): 10 to 25 bar

## Article number

**ETCM-D9.4-23.5-twin**

## Product image



## Product dimensions

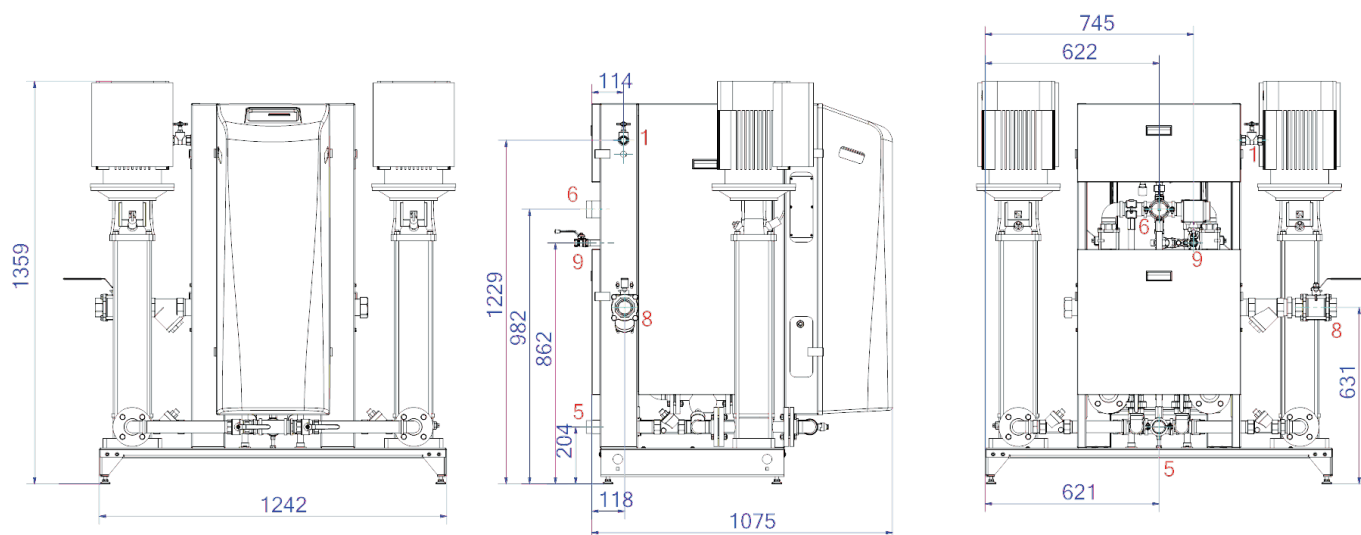

1. Refill connection	Rp1/2, Rp3/4
5. Suction line from expansion vessel	R6/4
6. Overflow line to the expansion tank	R6/4

8. Expansion pressure pipe	Rp6/4
9. Degassing pipe	Rp1/2

# Product data sheet Spirotech

## ETIM product data

Height	1359 mm	Double pump/compressor unit	Yes
Max. operating pressure	23.5 bar	With exchangeable membrane	No
Connection	Other	Compressor in base	No
Power consumption	6.2 kW	Nominal diameter expansion connection	1 1/2 inch (40)
Couplable	Yes	Max. medium temperature (continuous)	70 °C
Electrical connection	Connection cable with plug	For heating systems up to	1 MW
Function master/slave	No	Horizontal positioning	No
With pressure expansion vessel	No	Connection voltage	400 V
Digital control unit	Yes	Article compression class	PN 25

### Disclaimer

This product sheet has been compiled with the greatest possible care. Nevertheless, it may contain errors or omissions. For the most current and correct information we refer you to our website.

