

Data Sheet | Item Number: 771-5001/198-000

pre-assembled connecting cable; Cca; Plug/open-ended; 5-pole; Cod. I; H05Z1Z1-F
3G 1.5 mm²; 2 m; 1,50 mm²; blue

<https://www.wago.com/771-5001/198-000>

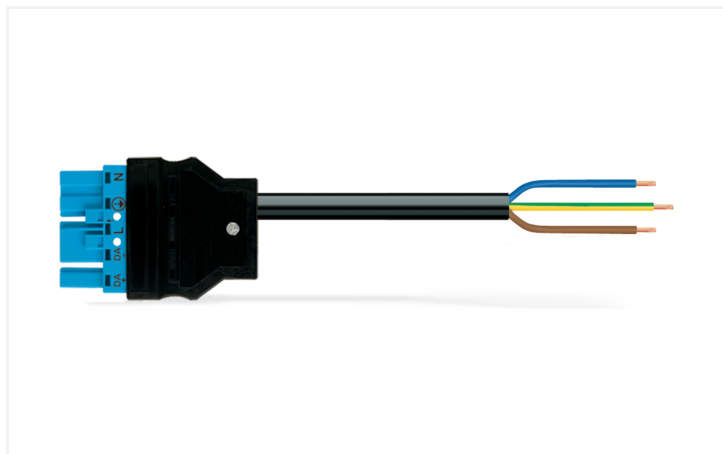

Color: ■ blue

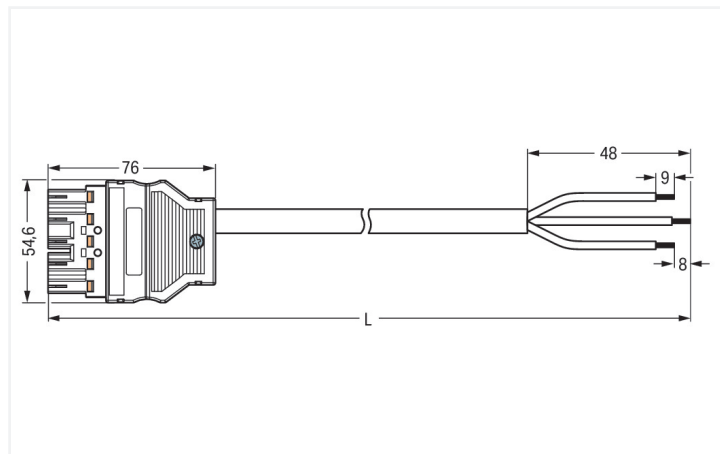

Dimensions in mm

Cable assembly WINSTA® MIDI 5-pole

The WINSTA® MIDI cable assembly with protection type IP20 is the pluggable solution for your use in control cabinets, for lighting connections or on PCBs. WAGO pluggable installation connectors are used when specifications repeat or are distributed on a specified pattern, for example for installing grid lighting or flush-mount lighting. For greater protection in electrical installations, the pluggable installation connector is provided with mechanical protection against mismatching. The pluggable installation connector is protected in accordance with protection type IP20 (When mated: IP2xC (These compact connectors are not designed for use in open, easily accessible areas!)). This means that users' fingers will never come into contact with live elements. WINSTA® MIDI pluggable installation connectors with I coding in blue are above all suitable for easy lighting installation, for example for the dimming of DALI lights. The WINSTA® MIDI Pluggable Connection System with Push-in CAGE CLAMP® spring pressure connection technology facilitates safe electrification. Due to the included test slot, connections can be checked even when they are plugged in. This saves time, labor, and money. If you need to satisfy stricter safety standards, you should use cables with fire class C. These are suitable for use in buildings with primarily high demands on safety. Eliminating halogens as an additive in the manufacture of this cable assembly substantially increases fire safety and reduces environmental contamination.

Fast, error-free assembly thanks to cable assemblies from WAGO

The cable is pre-assembled with a plug and a free end. The WINSTA® Pluggable Connection System allows pluggable electrical installation. This saves time, lowers costs, and reduces the need for servicing. Now you can also lower installation costs without compromising safety and quality: with strain relief hosting eliminates the need for servicing and prevents unnecessary downtime.

- pluggable installation connectors with protection against mismatching
- simple circuits
- with I coding for use in the automation of buildings (lighting control)
- custom-engineered solutions
- quick replacement of defective units during ongoing operation

Notes

Note Cables with a different fire class can be found in the eShop.

Electrical data

Ratings per	IEC/EN 60664-1			General information	
Overvoltage category	III	III	II	Note on contact resistance	approx. 1 mΩ of contact resistance approx. 0.25 mΩ contact transition plug/ socket
Pollution degree	3	2	2		
Nominal voltage	250 V	-	-		
Rated impulse withstand voltage	4 kV	-	-		
Rated current	16 A	-	-		

Connection Data

Total number of potentials	3	Connection 1	
PE function	Preceding PE contact	Strip length	9 mm / 0.35 inches
Conductor preparation	ultrasonically tip-bonded	Pole number	5
		Wire cross-section	1.5 mm ²
		Strip length (outer insulation)	48 mm
		Connection type	Plug - free end

Physical data

Pin spacing	10 mm / 0.394 inches
Width	54.6 mm / 2.15 inches
Height	17 mm / 0.669 inches
Total length	2 m

Mechanical data

Use	DALI, Lighting Management
Coding	I
Variable coding	No
Marking	N ⊕ L DA- DA+
Mating force of a plug-in connection	approx. 20 ... 70 N (depending on pole number)
Retention force of a plug-in connection	when locked: > 80N
Unmating force of a plug-in connection	when unlocked: approx. 20 ... 70 N (depending on pole number)
Number of mating cycles	200, without resistive load
Connection type	Plug - free end
Type of pre-assembled cable	Connecting cable
Cable type	H05Z1Z1-F 3G1.5
Protection type	IP20; When mated: IP2xC (These compact connectors are not designed for use in open, easily accessible areas!)

Plug-in connection

Mismating protection	Yes
Note on mismating protection	All WINSTA® components are 100% protected against mismating when: a.) plugging different numbers of poles b.) plugging while rotated 180 c.) plugging while laterally staggered d.) plugging one pole
Locking lever	Can be retrofitted
Locking of plug-in connection	Locking lever
Note on locking system	All connectors for mounted installations (snap-in versions for lighting fixtures or devices, all types of PCB and distribution connectors) are factory-equipped with locking levers to ensure plugs and sockets are securely locked. Additional locking levers are only required for flying leads (plug/socket).

Material data

Note (material data)	Information on material specifications can be found here
Color	blue
Insulation material (main housing)	Polyamide (PA66)
Flammability class per UL94	V0
Fire class per EN 50575	C _{ca}
Contact material	Copper or copper alloy; surface-treated
Contact Plating	Tin
Fire load	19.941 MJ
Connector color	blue
Strain relief color	black
Sheathed cable color	black
Printing color of sheathed cable	white
Halogen-free	Yes
Silicon-free	Yes
Sheath material	Halogen-free
Rubber cable	No
Weight	230.2 g
Copper weight of the raw cable	0.043 kg/m

Environmental requirements

Processing temperature	-5 ... +40 °C
Continuous operating temperature	-35 ... +85 °C
Note on continuous operating temperature	Cable for temperatures ≤ 70 °C (including halogen-free) Insulating parts for temperatures ≤ 105 °C

Commercial data

PU (SPU)	1 pcs
Packaging type	unpacked
Country of origin	DE
GTIN	4055143808644
Customs tariff number	85444290900

Product Classification

UNSPSC	26121629
eCl@ss 10.0	27-44-06-04
eCl@ss 9.0	27-44-06-04
ETIM 9.0	EC002587
ETIM 10.0	EC002587
ECCN	NO US CLASSIFICATION

Environmental Product Compliance

RoHS Compliance Status	Compliant, No Exemption
------------------------	-------------------------

Downloads

Environmental Product Compliance

Compliance Search





Environmental Product Compliance
771-5001/198-000 

1 Compatible Products

1.1 Required Accessories

1.1.1 Locking system

1.1.1.1 Locking system

			
Item No.: 770-101 Locking lever; for flying leads; for manual operation; black	Item No.: 770-121 Locking lever; for flying leads; for manual operation; white	Item No.: 770-111 Locking lever; for flying leads; for tool operation; black	Item No.: 770-131 Locking lever; for flying leads; for tool operation; white

1.2 Optional Accessories

1.2.1 Cover

1.2.1.1 Cover



[Item No.: 770-360](#)
Lockout cap; for plugs; 5-pole; separable; yellow

1.2.2 Installation

1.2.2.1 Mounting accessories



Item No.: 770-310

Mounting carrier; 2- to 5-pole; for flying leads; black

1.2.3 Marking

1.2.3.1 Marker



Item No.: 770-450/000-006

Marker card; Plastic; blue



Item No.: 770-450/000-001

Marker card; Plastic; green



Item No.: 770-450/000-012

Marker card; Plastic; orange



Item No.: 770-450/000-005

Marker card; Plastic; red



Item No.: 770-450

Marker card; Plastic; white



Item No.: 770-450/000-002

Marker card; Plastic; yellow

1.2.3.2 Marking strip



Item No.: 210-334

Marking strips; as a DIN A4 sheet; Strip width 5 mm; Strip length 182 mm; plain; Self-adhesive; white