

Concord

Solstice 150 1250lm 930 DALI GB
2070227



Features

- The Solstice 150 1250lm 930 DALI GB is a high efficient DALI dimmable downlight luminaire, Colour rendering index Ra>90, Colour temperature: 3000K Warm White, Class II, Protection rating IP40/IP20, Cut out dimensions: 150mm.

Product Overview

Product name	Solstice 150 1250lm 930 DALI GB
Technology	LED
Cap/Base	N/A
Housing	Aluminium
Mount	Ceiling recessed mounting
General application	Retail
ETIM Class	EC001744
E-number FI	4262063
Fixture luminous flux (lm)	1250
Luminaire efficacy (lm/W)	83
LOR (%)	100
Correlated colour temperature (k)	3000
Light colour	Warm White
CRI (Ra)	90
Colour Consistency (SDCM)	3
Colour Variation Initial (SDCM)	3
Beam Angle (°)	70
Glare control	< 19
Photobiological Risk Group	RG0

Concord

Solstice 150 1250lm 930 DALI GB
2070227

Total power consumption (W)	15
Electrical protection	Class II
Control gear type	LED driver constant current
Dimmable	Yes
Minimum dimming level (%)	1
LED Flickering Rate	Ultra low (5% or less)
Housing colour	RAL9005
IP rating	IP40/20
IK rating	IK02
Product EAN number	5025768702275
Warranty	5 years
Dimming method	DALI, DALI-2, Switch-dim (mains-rated)

Photometry

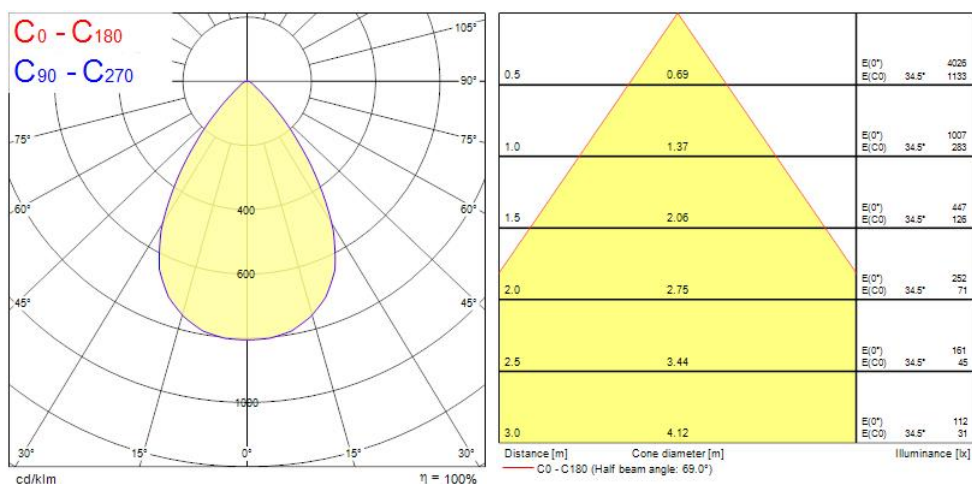

Concord

Solstice 150 1250lm 930 DALI GB
2070227

Technical drawings

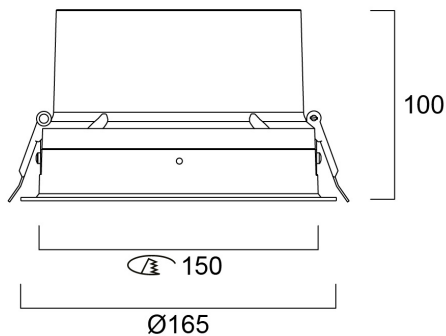

Data table

GENERAL DATA

Product name	Solstice 150 1250lm 930 DALI GB
Technology	LED
Cap/Base	N/A
Housing	Aluminium
Mount	Ceiling recessed mounting
General application	Retail
Operating temperature range (°C)	-10°C...+40°C
Performance ambient temperature Tq (°C)	40
ETIM Class	EC001744
E-number FI	4262063
Warranty	5 years

OPTICAL DATA

Fixture luminous flux (lm)	1250
Luminaire efficacy (lm/W)	83

Concord

Solstice 150 1250lm 930 DALI GB
2070227

LOR (%)	100
Correlated colour temperature (k)	3000
Light colour	Warm White
CRI (Ra)	90
Colour Variation Initial (SDCM)	3
Colour Consistency (SDCM)	3
Beam Angle (°)	70
Distribution type	Symmetric
Glare control	< 19
Photobiological Risk Group	RG0

ELECTRICAL DATA

Total power consumption (W)	15
Current (A)	400
Primary Supply/Product voltage - min (V)	220.0
Primary Supply/Product voltage - max (V)	240.0
Lamp power factor	0.98
THD (at 230 V, 50 Hz, full load, at 100% dimming level) ≤ xx.x %	9
Electrical protection	Class II
Control gear required	No
Control gear type	LED driver constant current
Dimmable	Yes
Dimming method	DALI, DALI-2, Switch-dim (mains-rated)
Minimum dimming level (%)	1
Drive current (mA)	400
Inrush Current (A)	18
Inrush Duration (µs)	140
Energy Efficiency Class (A->G) of contained light source	C
Nominal Frequency (Hz)	50/60Hz
LED Flickering Rate	Ultra low (5% or less)
Max. products per 10A C Breaker	36
Max. products per 13A C Breaker	50
Max. products per 16A C Breaker	60

Concord

Solstice 150 1250lm 930 DALI GB 2070227

Max. products per 20A C Breaker	76
Max. products per 10A B Breaker	22
Max. products per 13A B Breaker	30
Max. products per 16A B Breaker	36
Max. products per 20A B Breaker	46
Connectable conductor cross section - Min (mm ²)	0.5
Connectable conductor cross section - Max (mm ²)	2.5

LIFETIME DATA

Lifespan L70 B50	120000
Lifespan L80 B20	120000
Lifespan L80 B10	120000
Lifespan L90 B10	74000

PHYSICAL DATA

Housing colour	RAL9005
IP rating	IP40/20
IK rating	IK02
Diffuser finish	Diffuse
Diffuser material	PC Polycarbonate
Reflector finish	Other
Nominal Product Height (mm)	100
Nominal Product Diameter (mm)	165
Built-in diameter (mm)	150
Max. Lamp Diameter (mm) - D	165
Weight (kg)	0.95
Recessed Depth (mm)	150

PACKAGING

Product EAN number	5025768702275
Packaging single length / height (cm)	27.5
Packaging single width (cm)	25.0

Concord

Solstice 150 1250lm 930 DALI GB
2070227

Packaging single depth (cm)	12.5
DUN14 (inner)	05025768702275
Units per outer package	1
Packaging outer length / height (cm)	27.5
Packaging outer width (cm)	25.0
Packaging outer depth (cm)	12.5

SAFETY DATA

Glow Wire Test (°C)	850
Optimal operating condition (°C)	-10-40
Special purpose lamp	No
Dry applications use only	No
Suitable for household illumination	No