

Data Sheet | Item Number: 236-405

PCB terminal block; 2.5 mm²; Pin spacing 5/5.08 mm; 5-pole; CAGE CLAMP®; commoning option; gray

<https://www.wago.com/236-405>

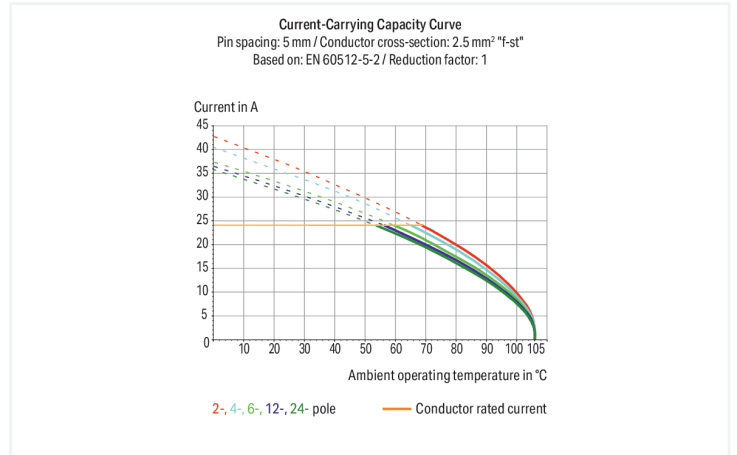

Color: ■ gray

Similar to illustration

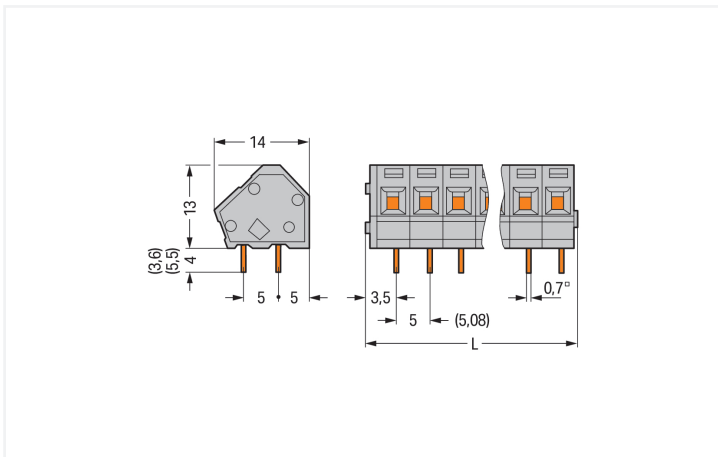

Dimensions in mm

$L = (\text{pole no.} \times \text{pin spacing}) + 2.3 \text{ mm}$

PCB terminal block, 236 Series, operating tool

Our PCB terminal block (item number 236-405) simplifies electrical installations. It offers the flexibility needed for different mounting types. Strip lengths must be between 5 and 6 mm when connecting conductors to this PCB terminal block. This product features one conductor terminal and utilizes CAGE CLAMP®. Our trusted universal connection known as CAGE CLAMP® leads the way when it comes to connection technology and electrical interconnections. Dimensions: (27.3 x 17 x 14) mm (width x height x depth). Depending on the type of conductor, this PCB terminal block is suitable for conductor cross sections ranging from 0.08 mm² to 2.5 mm².

The contact surface is coated with tin. This PCB terminal block is operated with an operating tool. The PCB terminal block is designed for THT soldering. The conductor is designed to be inserted at a 45° angle..

Notes

Variants: 	Other pole numbers Versions for Ex e II and Ex i Other colors Mixed-color PCB connector strips Direct marking Solder pin length: 3.6 mm Solder pin length: 5.5 mm Other versions (or variants) can be requested from WAGO Sales or configured at https://configurator.wago.com/ .
-------------------	---

Electrical data

Ratings per	IEC/EN 60664-1			Approvals per	UL 1059		
Overvoltage category	III	III	II	Use group	B	C	D
Pollution degree	3	2	2	Rated voltage	300 V	-	300 V
Nominal voltage	250 V	320 V	630 V	Rated current	15 A	-	10 A
Rated impulse withstand voltage	4 kV	4 kV	4 kV				
Rated current	24 A	24 A	24 A				

Approvals per	CSA		
Use group	B	C	D
Rated voltage	300 V	-	300 V
Rated current	15 A	-	10 A

Connection Data

Clamping units	5	Connection 1	
Total number of potentials	5	Connection technology	CAGE CLAMP®
Number of connection types	1	Actuation type	Operating tool
Number of levels	1	Solid conductor	0.08 ... 2.5 mm ² / 28 ... 12 AWG
		Fine-stranded conductor	0.08 ... 2.5 mm ² / 28 ... 12 AWG
		Fine-stranded conductor; with insulated ferrule	0.25 ... 1.5 mm ²
		Fine-stranded conductor; with uninsulated ferrule	0.25 ... 1.5 mm ²
		Note (conductor cross-section)	12 AWG: THHN, THWN
		Strip length	5 ... 6 mm / 0.2 ... 0.24 inches
		Conductor connection direction to PCB	45°
		Pole number	5

Physical data

Pin spacing	5/5.08 mm / 0.197/0.2 inches
Width	27.3 mm / 1.075 inches
Height	17 mm / 0.669 inches
Height from the surface	13 mm / 0.512 inches
Depth	14 mm / 0.551 inches
Solder pin length	4 mm
Solder pin dimensions	0.7 x 0.7 mm
!	1.1 ^(+0.1) mm

PCB contact

PCB contact	THT
Solder pin arrangement	over the entire terminal strip (in-line)
Number of solder pins per potential	2

Material data

Note (material data)	Information on material specifications can be found here
Color	gray
Material group	I
Insulation material (main housing)	Polyamide (PA66)
Flammability class per UL94	V0
Clamping spring material	Chrome-nickel spring steel (CrNi)
Contact material	Electrolytic copper (E _{cu})
Contact Plating	Tin
Fire load	0.064 MJ
Weight	4.4 g

Environmental requirements

Limit temperature range	-60 ... +105 °C
-------------------------	-----------------

Commercial data

Product Group	4 (Printed Circuit Connectors)
PU (SPU)	180 (45) pcs
Packaging type	Box
Country of origin	CH
GTIN	4044918769495
Customs tariff number	85369010000

Product Classification

UNSPSC	39121409
eCl@ss 10.0	27-44-04-01
eCl@ss 9.0	27-44-04-01
ETIM 9.0	EC002643
ETIM 10.0	EC002643
ECCN	NO US CLASSIFICATION

Environmental Product Compliance

RoHS Compliance Status	Compliant, No Exemption
------------------------	-------------------------

Approvals / Certificates

General approvals



Approval	Standard	Certificate Name
CSA DEKRA Certification B.V.	C22.2 No. 158	1673957
UL Underwriters Laboratories Inc.	UL 1059	UL-US-2406095-0

Approvals for marine applications



Approval	Standard	Certificate Name
BV Bureau Veritas S.A.	IEC 60998	11915/E0 BV

Downloads

Environmental Product Compliance

Compliance Search

Environmental Product Compliance 236-405



Documentation

Additional Information

Technical Section	03.04.2019	pdf 2027.26 KB	
Gebrückte Klemmenleisten für Leiterplatten		pdf 303.71 KB	

CAD/CAE-Data

CAD data

2D/3D Models 236-405



CAE data

ZUKEN Portal 236-405



PCB Design

Symbol and Footprint via SamacSys 236-405



Symbol and Footprint via Ultra Librarian 236-405



1 Compatible Products

1.1 Optional Accessories

1.1.1 Ferrule

1.1.1.1 Ferrule



Item No.: 216-301
Ferrule; Sleeve for 0.25 mm² / AWG 24; insulated; electro-tin plated; yellow



Item No.: 216-321
Ferrule; Sleeve for 0.25 mm² / AWG 24; insulated; electro-tin plated; yellow



Item No.: 216-151
Ferrule; Sleeve for 0.25 mm² / AWG 24; uninsulated; electro-tin plated



Item No.: 216-131
Ferrule; Sleeve for 0.25 mm² / AWG 24; uninsulated; electro-tin plated; silver-colored



Item No.: 216-302
Ferrule; Sleeve for 0.34 mm² / 22 AWG; insulated; electro-tin plated; light turquoise



Item No.: 216-322
Ferrule; Sleeve for 0.34 mm² / 22 AWG; insulated; electro-tin plated; light turquoise



Item No.: 216-132
Ferrule; Sleeve for 0.34 mm² / AWG 24; uninsulated; electro-tin plated



Item No.: 216-152
Ferrule; Sleeve for 0.34 mm² / AWG 24; uninsulated; electro-tin plated



Item No.: 216-201
Ferrule; Sleeve for 0.5 mm² / 20 AWG; insulated; electro-tin plated; electrolytic copper; acc. to DIN 46228, Part 4/09.90; white



Item No.: 216-241
Ferrule; Sleeve for 0.5 mm² / 20 AWG; insulated; electro-tin plated; electrolytic copper; gastight crimped; acc. to DIN 46228, Part 4/09.90; white













Item No.: 216-221
Ferrule; Sleeve for 0.5 mm² / 20 AWG; insulated; electro-tin plated; white











Item No.: 216-141
Ferrule; Sleeve for 0.5 mm² / 20 AWG; uninsulated; electro-tin plated; electrolytic copper; gastight crimped; acc. to DIN 46228, Part 1/08.92

1.1.1.1 Ferrule

 <p>Item No.: 216-101 Ferrule; Sleeve for 0.5 mm² / AWG 22; un-insulated; electro-tin plated; silver-colored</p>	 <p>Item No.: 216-121 Ferrule; Sleeve for 0.5 mm² / AWG 22; un-insulated; electro-tin plated; silver-colored</p>	 <p>Item No.: 216-242 Ferrule; Sleeve for 0.75 mm² / 18 AWG; insulated; electro-tin plated; electrolytic copper; gastight crimped; acc. to DIN 46228, Part 4/09.90; gray</p>	 <p>Item No.: 216-262 Ferrule; Sleeve for 0.75 mm² / 18 AWG; insulated; electro-tin plated; electrolytic copper; gastight crimped; acc. to DIN 46228, Part 4/09.90; gray</p>
 <p>Item No.: 216-202 Ferrule; Sleeve for 0.75 mm² / 18 AWG; insulated; electro-tin plated; gray</p>	 <p>Item No.: 216-222 Ferrule; Sleeve for 0.75 mm² / 18 AWG; insulated; electro-tin plated; gray</p>	 <p>Item No.: 216-142 Ferrule; Sleeve for 0.75 mm² / 18 AWG; un-insulated; electro-tin plated; electrolytic copper; gastight crimped; acc. to DIN 46228, Part 1/08.92</p>	 <p>Item No.: 216-102 Ferrule; Sleeve for 0.75 mm² / AWG 20; un-insulated; electro-tin plated; silver-colored</p>
 <p>Item No.: 216-122 Ferrule; Sleeve for 0.75 mm² / AWG 20; un-insulated; electro-tin plated; silver-colored</p>	 <p>Item No.: 216-243 Ferrule; Sleeve for 1 mm² / AWG 18; insulated; electro-tin plated; electrolytic copper; gastight crimped; acc. to DIN 46228, Part 4/09.90; red</p>	 <p>Item No.: 216-263 Ferrule; Sleeve for 1 mm² / AWG 18; insulated; electro-tin plated; electrolytic copper; gastight crimped; acc. to DIN 46228, Part 4/09.90; red</p>	 <p>Item No.: 216-203 Ferrule; Sleeve for 1 mm² / AWG 18; insulated; electro-tin plated; red</p>
 <p>Item No.: 216-223 Ferrule; Sleeve for 1 mm² / AWG 18; un-insulated; electro-tin plated; red</p>	 <p>Item No.: 216-103 Ferrule; Sleeve for 1 mm² / AWG 18; un-insulated; electro-tin plated</p>	 <p>Item No.: 216-143 Ferrule; Sleeve for 1 mm² / AWG 18; un-insulated; electro-tin plated; electrolytic copper; gastight crimped; acc. to DIN 46228, Part 1/08.92</p>	 <p>Item No.: 216-123 Ferrule; Sleeve for 1 mm² / AWG 18; un-insulated; electro-tin plated; silver-colored</p>
 <p>Item No.: 216-204 Ferrule; Sleeve for 1.5 mm² / AWG 16; insulated; electro-tin plated; black</p>	 <p>Item No.: 216-224 Ferrule; Sleeve for 1.5 mm² / AWG 16; insulated; electro-tin plated; black</p>	 <p>Item No.: 216-244 Ferrule; Sleeve for 1.5 mm² / AWG 16; insulated; electro-tin plated; electrolytic copper; gastight crimped; acc. to DIN 46228, Part 4/09.90; black</p>	 <p>Item No.: 216-264 Ferrule; Sleeve for 1.5 mm² / AWG 16; insulated; electro-tin plated; electrolytic copper; gastight crimped; acc. to DIN 46228, Part 4/09.90; black</p>
 <p>Item No.: 216-284 Ferrule; Sleeve for 1.5 mm² / AWG 16; insulated; electro-tin plated; electrolytic copper; gastight crimped; acc. to DIN 46228, Part 4/09.90; black</p>	 <p>Item No.: 216-124 Ferrule; Sleeve for 1.5 mm² / AWG 16; un-insulated; electro-tin plated</p>	 <p>Item No.: 216-144 Ferrule; Sleeve for 1.5 mm² / AWG 16; un-insulated; electro-tin plated; electrolytic copper; gastight crimped; acc. to DIN 46228, Part 1/08.92; silver-colored</p>	 <p>Item No.: 216-104 Ferrule; Sleeve for 1.5 mm² / AWG 16; un-insulated; electro-tin plated; silver-colored</p>

1.1.2 Marking

1.1.2.1 Marking strip

 <p>Item No.: 210-332/500-202 Marking strips; as a DIN A4 sheet; MARKED; 1-16 (160x); Height of marker strip: 3 mm; Strip length 182 mm; Horizontal marking; Self-adhesive; white</p>	 <p>Item No.: 210-332/508-202 Marking strips; as a DIN A4 sheet; MARKED; 1-16 (160x); Height of marker strip: 3 mm; Strip length 182 mm; Horizontal marking; Self-adhesive; white</p>	 <p>Item No.: 210-332/500-205 Marking strips; as a DIN A4 sheet; MARKED; 1-32 (80x); Height of marker strip: 3 mm; Strip length 182 mm; Horizontal marking; Self-adhesive; white</p>	 <p>Item No.: 210-332/508-205 Marking strips; as a DIN A4 sheet; MARKED; 1-32 (80x); Height of marker strip: 3 mm; Strip length 182 mm; Horizontal marking; Self-adhesive; white</p>
 <p>Item No.: 210-332/500-204 Marking strips; as a DIN A4 sheet; MARKED; 17-32 (160x); Height of marker strip: 3 mm; Strip length 182 mm; Horizontal marking; Self-adhesive; white</p>	 <p>Item No.: 210-332/508-204 Marking strips; as a DIN A4 sheet; MARKED; 17-32 (160x); Height of marker strip: 3 mm; Strip length 182 mm; Horizontal marking; Self-adhesive; white</p>	 <p>Item No.: 210-332/500-206 Marking strips; as a DIN A4 sheet; MARKED; 33-48 (160x); Height of marker strip: 3 mm; Strip length 182 mm; Horizontal marking; Self-adhesive; white</p>	 <p>Item No.: 210-332/508-206 Marking strips; as a DIN A4 sheet; MARKED; 33-48 (160x); Height of marker strip: 3 mm; Strip length 182 mm; Horizontal marking; Self-adhesive; white</p>

1.1.3 Stickers with operating instructions

1.1.3.1 Stickers with operating instructions



Item No.: 210-191

Stickers for operating instructions; for PCB terminal blocks; 236 Series

1.1.4 Test and measurement

1.1.4.1 Testing accessories



Item No.: 231-127

Testing plug module with contact stud; for 236 Series; Pin spacing 5 mm / 0.197 in; 2,50 mm²; gray



Item No.: 231-128

Testing plug module with contact stud; Pin spacing 5.08 mm / 0.2 in; 2,50 mm²; orange

1.1.5 Tool

1.1.5.1 Operating tool



Item No.: 210-658

Operating tool; Blade: 3.5 x 0.5 mm; with a partially insulated shaft; angled; short; multicoloured



Item No.: 210-720

Operating tool; Blade: 3.5 x 0.5 mm; with a partially insulated shaft; multicoloured



Item No.: 210-657

Operating tool; Blade: 3.5 x 0.5 mm; with a partially insulated shaft; short; multicoloured



Item No.: 236-335

Operating tool; gray



Item No.: 236-332

Operating tool; natural

Installation Notes

Conductor termination



Inserting a conductor via 3.5 mm screwdriver. Screwdriver actuation parallel to conductor entry

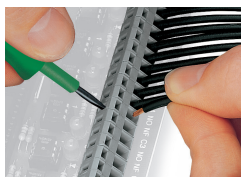

Inserting a conductor via 3.5 mm screwdriver. Screwdriver actuation perpendicular to conductor entry

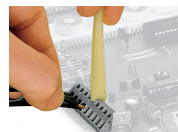

Inserting a conductor via operating tool.



Compared to standard screwdrivers, these operating tools are far more convenient for wiring PCB terminal strips at factory.

Installation



PCB Terminal Strips placed behind each other save space – staggering them by half the pin spacing simplifies subsequent wiring of the first row.

Installation



Combining PCB terminal blocks with different pin spacing.

Marking



Optional: Labeling via factory direct marking.

Optional: Labeling with self-adhesive marking strips possible