

DualGuard-S
Central battery system – emergency lighting

DualGuard-S – Make the leader your starting point



EATON

Powering Business Worldwide



Emergency lighting – Make the leader your starting point

Select Eaton for your Emergency lighting project and you will be working with the European market leader, bringing over 50 years of experience and expertise to your project.

- Named one of Fortune magazine's "World's Most Admired Companies" two years in a row
- Named one of Corporate Responsibility magazine's "100 Best Corporate Citizens"

We work closely with national and international industry organisations to achieve the highest standards of regulatory compliance, safety, reliability and efficiency.

Right across the world, environments are becoming increasingly urbanised and intricate, with a corresponding rise in associated safety threats. The challenge is multiplied when visitors are not familiar with layout and procedures. This is especially the case in large, highly populated, high-risk or complex premises such as railway stations, shopping centres, airports, stadia, government buildings or leisure facilities.



Emergency lighting – Central battery systems

Eaton's central battery systems provide safe, monitored and reliable power so that in the event of an emergency, you can be sure the safety lighting is showing the way, helping to evacuate building occupants in line with the emergency evacuation plan.



Features and benefits of DualGuard-S

1

Product description DualGuard-S.....	5
Certificates	6
DualGuard-S system overview.....	7
TFT touch display	8
Web visualisation.....	9
Battery string and battery block monitoring	10
Communication via the ACU CAN bus.....	11
VisionGuard, web visualisation and PC software	12

DualGuard-S product description

2

Advantages of DualGuard-S.....	14
DualGuard-S – switch to safety.....	15
DualGuard-S installation example	17
Overview of device models	20

DualGuard-S installation modules

3

TFT touch display 4.3" and 7"	26
ACU DG-S module	27
PSU module.....	28
AC trafo.....	29
BCM.1 module.....	30
CM.1 1.7 A and 3.4 A charging module.....	31
SKU.1 CG-S 4x1.5A circuit switching.....	32
SKU.1 CG-S 2x3A circuit switching.....	33
SKU.1 CG-S 1x6A circuit switching.....	34
SOU CG-S 2x4 A circuit switching	35
CG IV.1 relay module	36
CG V.1 relay module	37
RCM-A remote indication.....	38
3-PM module.....	39
3-PM-IO module	40
TLS bus module	41
BDM battery data module.....	42
BBS battery block sensor.....	43

Planning with DualGuard-S

4

Configuring the central battery system	44
Order details	46
Technical data	48
Determination of battery capacity.....	54
Adaptive evacuation	56

Supporting you

With over 50 years of experience designing & developing emergency lighting systems, we can help and advise you plan and advise you on all aspects of planning, installation and equipment service.

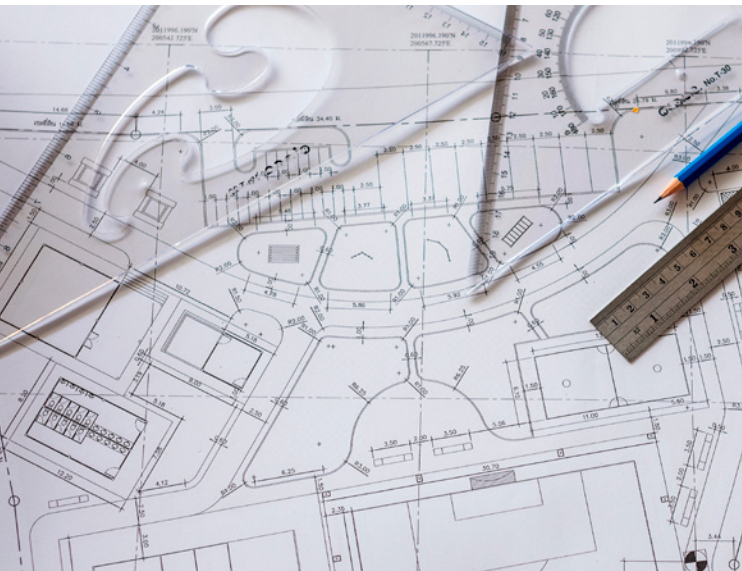

Planning

Our team of sales engineers have years of experience and are happy to provide answers to any questions you may have about the planning of a system and the technical standards for equipment you need to consider, to comply with building regulations.



Installation

Questions about design? How to reduce the costs of installation? Initial operation and training? Our team are standing by backed up by Europe's biggest supplier of Emergency lighting solutions helping to lessen your workload and keep project costs to the minimum.



Service

Need a service package that gives you or your client the ability to comply with the technical standard and gives you the ability to demonstrate compliance? Our Service team can ensure you are always up to date.

DualGuard-S – Modula design: Ready for the future

DualGuard-S (DG-S) is the next generation of Central Battery Systems, completely reengineered to create a fully configurable system to meet your projects needs today yet flexible enough to be reconfigured for the building of tomorrow.

- Reduce the cost of installation, commissioning and inspection
- State of the art technology, leading in design and quality.
- Compact footprint
- Safe, Intuitive, Flexible.

EN50171 ready, the DualGuard-S central battery system reliably supplies power to safety lighting and emergency lighting (230V AC/220 V DC), it automatically monitors itself as well as each individually connected CG-S luminaire (up to 20 per circuit)

Eaton's patented CEWA GUARD and STAR technology is provided as standard, both designed to reduce running costs.

Installation is streamlined, commissioning simplified and operational complexity minimised.



Saving up to 70% in power consumption, Eaton's innovative lighting technology combined with highly efficient LED's significantly lowers maintenance costs whilst delivering a life cycle of up to 50,000 hours.

Cabinet climate management

- The wiring system design avoids hotspots and allows for a higher module density within the cabinet, which includes large touch-proof ventilation slots for optimize heat dissipation.

Example:

DualGuard-S ESF/15P:

Tmax at +35°C ambient temperature = +45°C by 100% load.

ZB-S ESF30/13-P:

Tmax at +35°C ambient temperature = +53°C by 30% load.

DualGuard-S Key features

- auto search & auto inspection- fast commissioning & inspection
- no additional luminaire data cable required
- multiple system control streamlined – crosswise switching
- automatic fault detection
- improved monitoring solutions
- wireless battery block monitoring
- battery string monitoring
- isolation monitoring device with self-test
- phase monitoring devices with self-test
- improved heat dissipation, avoiding hotspots.
- improved cable entry options
- IP21 with IP31 option

Includes state of the art web server as standard plus new touch screen display options

Certification

DualGuard-S – central battery system

DualGuard-S – A step beyond conformity

Beyond the required CE declarations of conformity, Eaton offers system certification from accredited, independent test bodies for all emergency lighting products

This includes

- Safety lighting and emergency lighting
- Luminaires with built in modules
- Bus phase monitors
- Battery monitoring technology

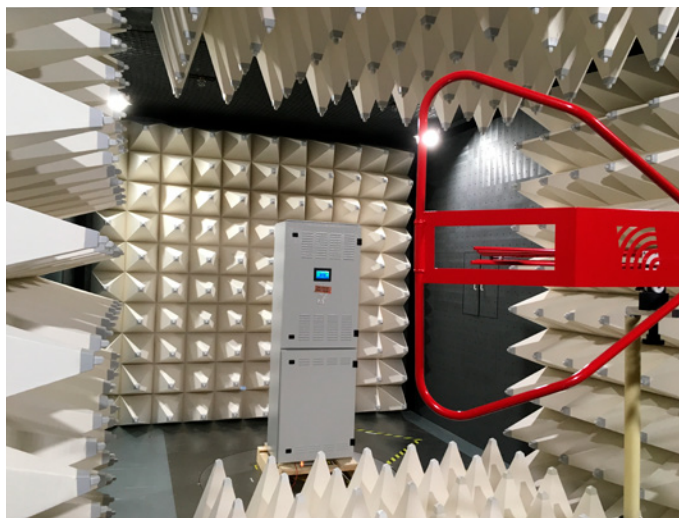

One of the most challenging areas under the EN50171 standard is EMV testing.

- To ensure the highest standards of compliance we utilise our in-house measuring chamber, this helps us to quickly refine and develop our emergency lighting systems ensuring they are safe and reliable before applying for third party certification, to achieve the highest of International standards.



Dual-Guard-S has undergone extensive 3rd party testing

- Battery string monitoring to updated EN50171
- Heating tests to EN 61439-1
- Floor-standing cabinets IP21 and IP31
- Wall cabinets IP54 and small distributors IP65
- Protection class tests according to EN60529
- Transport and vibration tests according to IEC 60068-2-64
- Shock test according to IEC 60068-2-227.

Eaton's cyber security

Like all connected devices a central battery system could be at risk from a security breach, resulting in operational downtime as well as impacting on the safety of building occupants. To combat this, all new Eaton systems and devices with Internet access undergo rigorous inspection and testing to ensure they are cyber secure including vulnerability and penetration testing.

Eaton is the only Emergency lighting manufacturer to have tested its Web controller to the exacting UL cyber security standards



Modules

Modules for temporary use at elevated environmental temperatures in the event of a fire and tested by an independent material testing facility.

Cable entry

Choose the right roof plate for your installation. Whether pre-drilled for M screw fittings and protective foil, or with bristles or sponge rubber.

Environmental tests

All cabinet models have undergone a variety of environmental tests- from the EMV measurement to the heating test- and been certified via an accredited test laboratory.

Hinge positions

Flexible door hinge, which can be easily changed ex works or on site by replacing the door. The swivel radius of 180° avoids blocking the maintenance aisle

Protection levels

All free standing cabinets are designed for IP 21 dripping water protection at the factory and can be upgraded to IP 31 on site.

The protection level of wall cabinets is at least IP 54 or higher.

Connection area

Except for the ACU DG-S module, all of the internal modules are wired to triple deck tension spring installation clamps, which include a neutral conductor separating clamp and enable convenient wiring.

Modular design

Using modules that have snap-on-click technology, the modules can be exchanged and the system expanded quickly and easily. The intuitive modular design and the spacious control circuit label fields make installation easier.

The wiring system provides a homogeneous cabinet climate and prevents heat build up, leading to a longer service life for the built-in modules.

Cabinet base

Cabinet bases for cable entry from below in 100 and 200 mm designs are available with all free-standing cabinets with a separate battery housing.

Separate battery compartment

Compliant with the technical standards regarding battery housings.

TFT touch display

The password protected TFT touch display with simple ICON controlled operation and menu profiles tailored to user groups supplies all information at a glance without having to open the distribution cabinet.

Special lock mechanism

Thanks to the standardised swivel handle, it is possible to install 20 mm profile half-cylinders.



TFT touch display – At a glance status indication with Intuitive menus

Under the standards governing central battery systems, a display unit is needed that can quickly and easily, identify at a glance the status of the unit. At the same time access needs to be restricted so that only authorised personnel are able to make changes to more advanced features such as the network system programming.



For the new TFT colour display, a new Graphical User interface has been developed (GUI) which features always on status indication, authorised user password protection and intuitive graphics.

Intuitive menu selection guides the user through the different levels of operation including configuration, programming and servicing.

Key Features

- All important system information for service, technical approvals and maintenance at a glance – outside of cabinet
- Powerful 32 bit processor, 4.3" screen can be upgraded to 7"
- USB slot for configuration changes, logbook and software updates.
- Display - IP65
- Touch Icons intuitive menu navigation through own operator level for initial commissioning, configuration, programming and service.
- All info text and status information multilingual
- Input of customer specific text in national language

Operators and installers have access to the detailed information they need for set up and service with essential system information available at a glance.

Web server as standard



Dual Guard-S provides as standard the ability to monitor and control the system remotely

- Password protected visualisation via your PC, tablet or mobile
- All functionality on the panel available remotely
- The status of each linked DualGuard-S system can be called up via any web browser.
- Configure & coordinate maintenance work remotely



Always up to date

Messages such as power failure, deep discharge protection, charging battery faults, isolation faults, control circuit faults and the device status can be sent to up to six email recipients

VisionGuard – clever visualisation



- Full visualisation, control and configuration down to the luminaire level
- Multi-user operation through web based client/server structure
- Independent parallel access of up to eight PC workstations
- Dongle free software licensing
- State-of-the-art, web based dashboard design with widgets (graphic window system)
- Responsive web design – automatic adaptation to different display resolutions
- Switchable day/night mode
- Detailed email functions with status emailing and alarm emailing
- Advanced printing functions
- Alarm list and inspection log function with filter option
- Cyber security checked

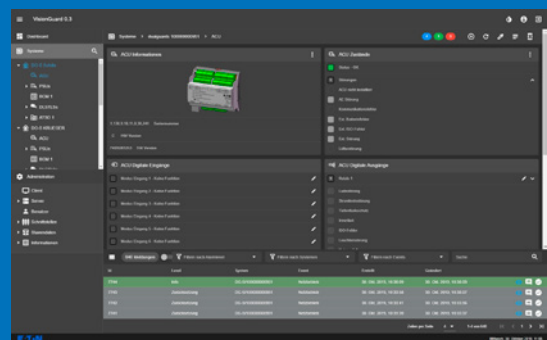
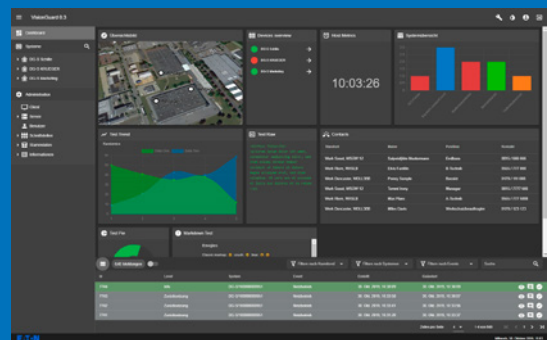

Web visualisation: VisionGuard

The new "VisionGuard" visualisation software offers complete monitoring, control and configuration of all connected DualGuard-S central battery systems all the way down to the luminaire level. The modern, web based client/server structure permits installation and operation in any number of Windows-based IT environments.

VisionGuard can be accessed via the customary web browsers that are a consistent of every operating system. This eliminates the need for elaborate installation and maintenance of proprietary client software. Furthermore, this enables platform independent use of the visualisation software. Through the responsive web design, the user interface automatically adapts to a variety of display sizes, meaning that mobile displays such as tablets or smart phones can be used for the visualisation software without any problems.

These advantages all combine to generate a high degree of user friendliness. VisionGuard shines with a multitude of features which offer the user plenty of opportunities for convenient notification and evaluation of the overall condition of the whole project, e.g. email, automatic printing functions, an alarm list with filter function, a comprehensive inspection log and much more.

VisionGuard focuses on the essentials and has an impressively clear design.

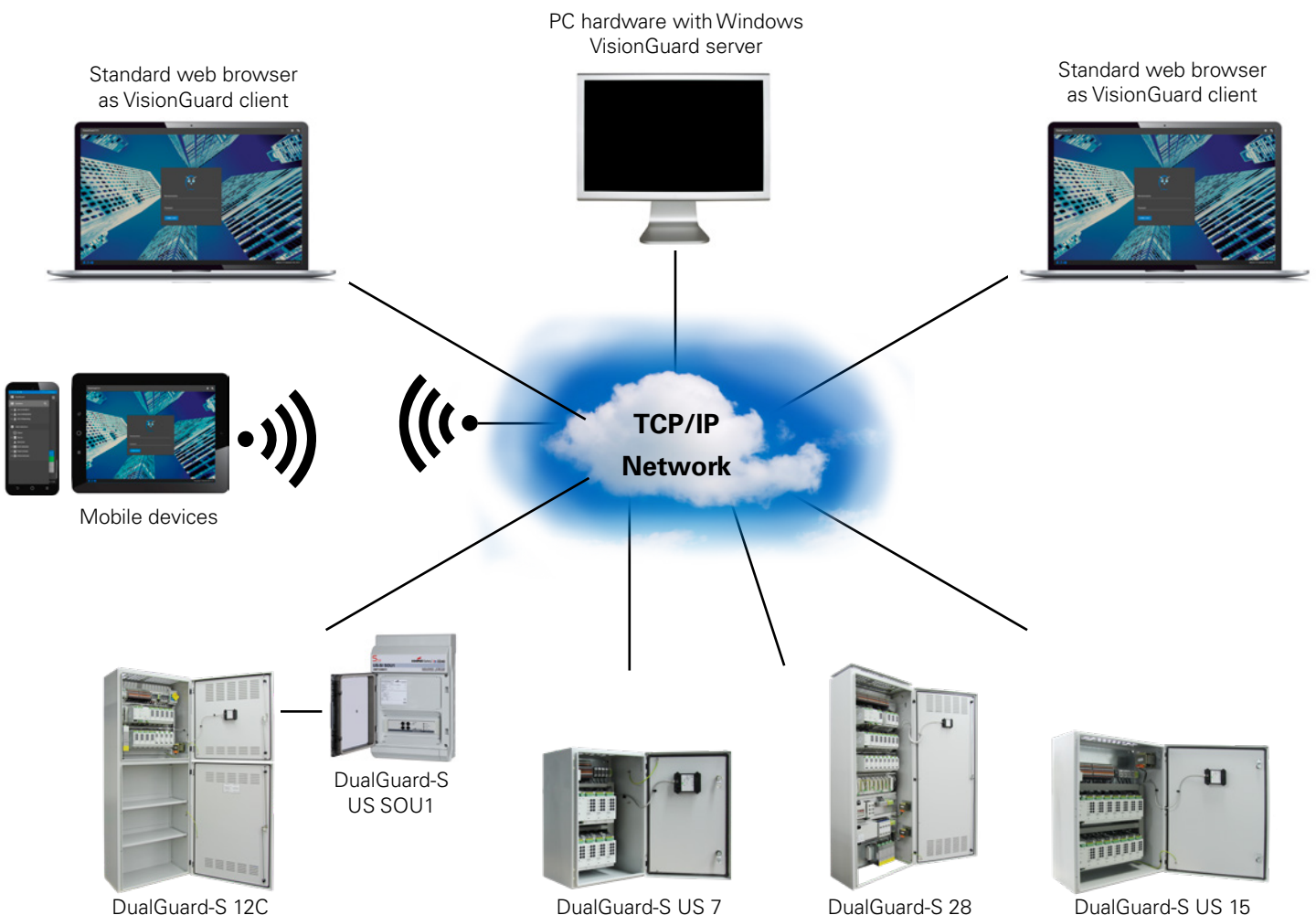

Communication via the ACU CAN bus

DualGuard-S – central battery system

Communication via the ACU DG-S bus

With the innovative ACU Bus, the need for duplicate wiring and modules to control luminaires across multiple systems is removed, configured with VisionGuard, complex set up, management and wiring is simplified and the associated cost reduced.

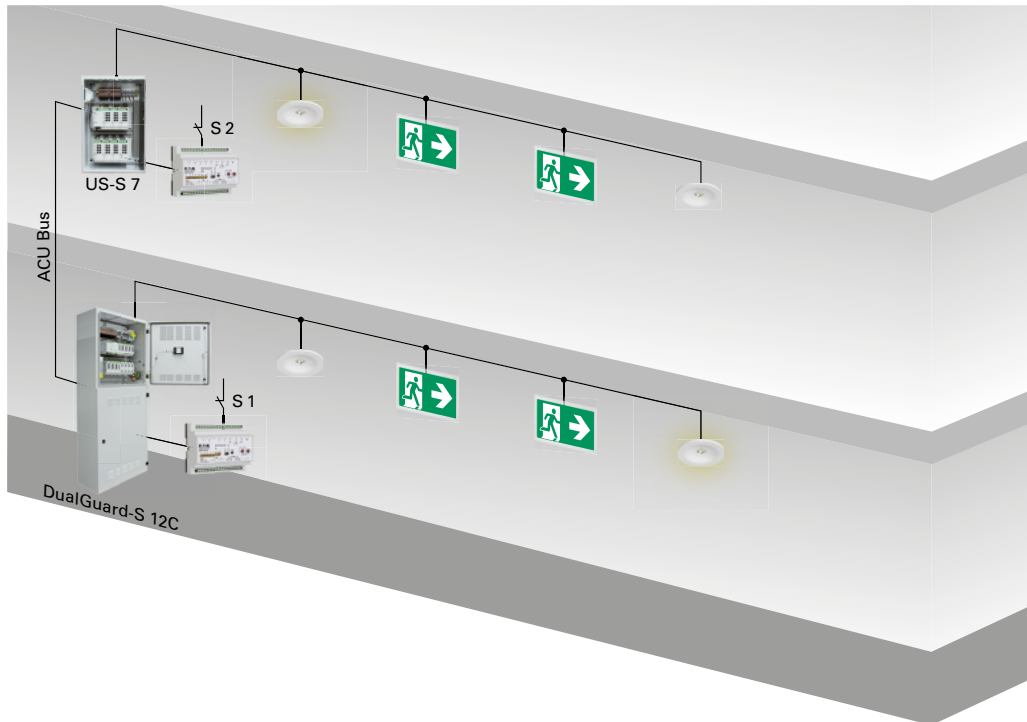

Example:

The S1 switch of the DualGuard-S 12C simultaneously switches on the DualGuard-S US 7 luminaires via the ACU DG-S bus CG-S and vice versa.



The ACU-Bus simplifies projects in complex buildings such as airports, shopping centres and multi-function buildings across the public and private sector including University Campuses and hospitals.

The new binding function allows all control, switching and phase monitoring functions of up to 32 DualGuard-S devices to be linked via the ACU DG-S bus to the connected CG-S luminaires.

- Simple Installation rules
- Only ACU-DG Bus connection and Ethernet Access to each device necessary
- Easy planning
- All applications are free programmable via WEB / VisionGuard and HMI
- Future proof – easily adapted for building extensions and change of use

Battery pack and battery block monitoring

In accordance with draft EN50171

Battery string monitoring

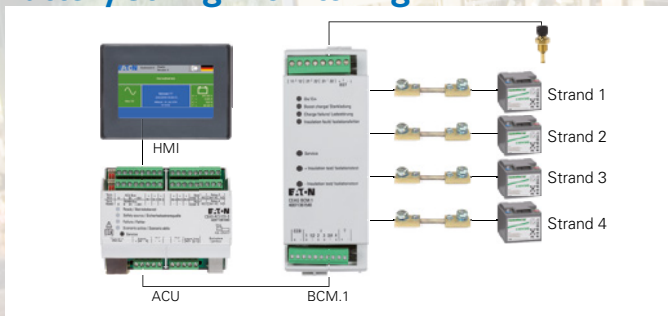

Battery block monitoring



Battery Pack monitoring

In the update to EN50171 EACH parallel battery string needs to be monitored separately. DualGuard-S features a range of fault monitoring solutions across individual battery packs to provide early warning and alarm indication and statistical analyses via display / web interface / VisionGuard

- Voltage for trickle charging is outside of the permissible range
- Battery charge circuit interrupted
- Faults in charging system
 - i.e. no charging current although the general power supply is available
- Feed from the battery although general power supply is available
- Warning that deep discharge protection has been triggered

Battery Block Monitoring

Battery Block Monitoring DualGuard-S features optional wireless battery block monitoring, reducing cabling and speeding up installation.

- Recording of voltage and temperature values during the continuous function test
- Wireless data transmission – no data line for sensors necessary
- Periodic monitoring of battery block voltages and temperatures
- Recording of voltage and temperature values during the continuous function test
- Message in the event of deviations and faults with each individual battery block if the voltage or temperature of one or more battery blocks deviates from the average value of voltage/temperatures of the other battery blocks
- Soft addressing of sensors
- Negative pole temperature measurement – easy and visible assembly of sensors possible
- Low power consumption of <24mW for operation in the event of lengthy charging interruptions

Advantages of DualGuard-S

DualGuard-S – central battery system

Advantages of DualGuard-S



LED search



Language



ISO fault

Fast initial operation through:

- **Luminaire search** – The automatic luminaire search function
- **Language** – Plain text status display on the TFT touch display down to the last luminaire in the local language
- **ISO fault** – Automatic isolation fault finding and display of the isolation fault according to LED current circuit

Strang 1 I: 1.60 A	Strang 2 I: 0.00 A
Strang 3 I: 0.00 A	Strang 4 I: 0.00 A

Battery string



Battery block



ISO monitor



3-PM-IO module

Time-saving automatic test through:

- **Battery string** – The automatic detection of faults in battery strings switched in parallel
- **Battery block** – The automatic early detection of faults of individual battery blocks
- **ISO monitors** – The automatic monitoring of the isolation monitor function
- **3-PM-IO module** – The automatic monitoring of the phase monitor modules



Luminaire monitoring

Reduced inspection effort through:

- **Luminaire monitoring** – Shorter inspection time using the CEWA GUARD technology, automatic function monitoring of up to 20 luminaires per circuit

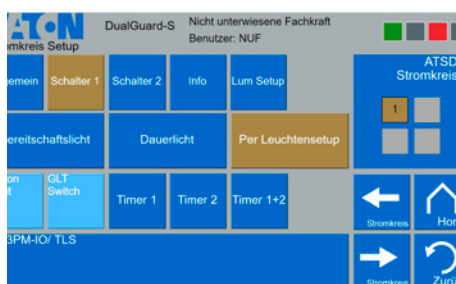

3-PM-IO programming

Reduced installation costs through:

- **3-PM-IO programming** – STAR technology and freely programmable mixed operation of switching types for each luminaire in one circuit

Switch to Reliability!

DualGuard-S is based on the proven STAR technology.

**Switching
Technology
Advanced
Revision,**

The **CG-STAR** technology offers the opportunity to operate multiple switching types in one and the same circuit, whereby the circuit type of each individual luminaire can be reprogrammed from a central point at any time.

As a result, this technology not only offers the proven CEWA Guard security when it comes to operating safety lighting systems, but also the safety and flexibility when planning the system, which can then respond to structural changes in the building or the use thereof at any time.

How STAR technology benefits you:

The number of final circuits is greatly reduced because continuous operation, the non-maintained mode, and switched maintained lighting are implemented in one common circuit. This enables shorter cable lengths, reduces installation costs, and lowers the fire loading. Of course, it is also possible to assign all of the operating modes retrospectively (**without having to change lighting installation**) which simplifies the configuration process because there is no need for operating mode planning.

As with the CEWA GUARD technology, no additional data cable for the luminaires is required with the patented STAR technology.

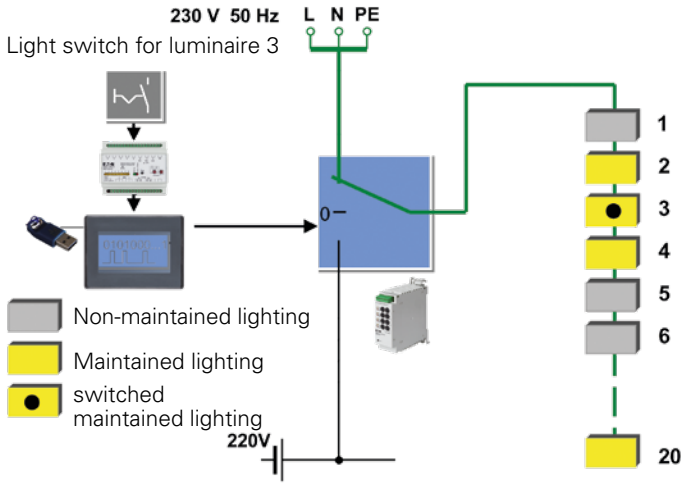

How STAR technology works

DualGuard-S – switch to safety

Central battery system

Switch to Reliability!

Cabling costs reduced

With traditional systems, each type of switching mode requires one circuit, with only one type of switching mode possible per circuit plus any modification require additional field work. Dual Guard-S utilizes Eaton's proven STAR technology so that only one circuit for all types of switching modes is required and no need for an additional data cable for luminaire monitoring, utilised with the web controller and any changes can be managed through the software rather than physical cabling changes.

- Multiple switching modes on the same circuit
- Operate or reprogram easily from the GUI / web controller
- Respond quickly to building structural changes
- Number of circuits greatly reduced
- Less cabling
- Reduced installation costs
- Simplified configuration process
- CG Technology for monitoring individual luminaires
- Monitor without additional wiring
- Comply to EN62034
- Automatic logging
- No additional data cable

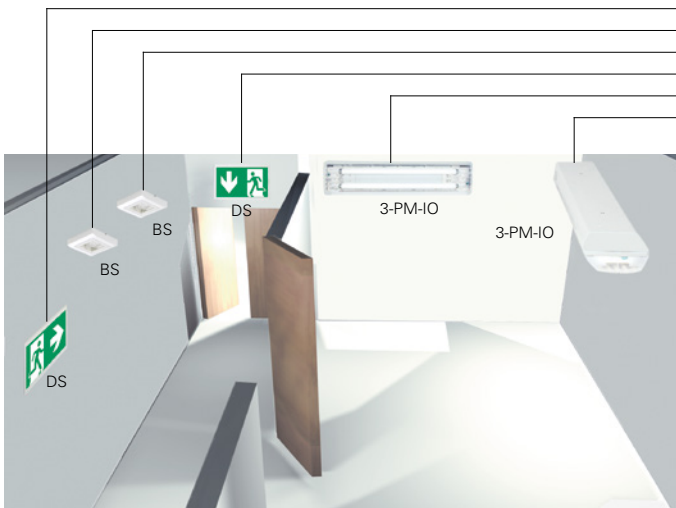

Conventional installation:

Maintained lighting 1 (DS)
non-maintained lighting 1 (BS)
non-maintained lighting 2 (BS)
maintained lighting 2 (DS)
switched maintained lighting 1 (3-PM-IO)
switched maintained lighting 2 (3-PM-IO)

- Each circuit type requires two circuits
- Only one circuit type is possible for each final circuit
- High installation costs for subsequent changes

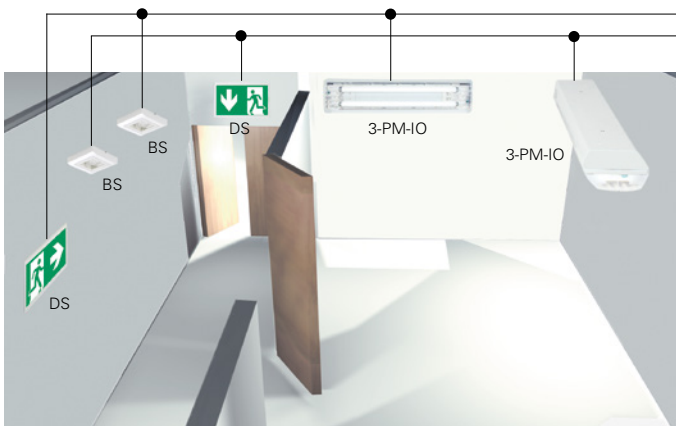

DualGuard-S installation with STAR technology:

All switching modes

- Only two final circuits for all circuits
- Continuous operation, non-maintained mode and switched maintained lighting are possible in one common circuit
- Subsequent changes to the switching mode are possible without any problems

Installation example

Country-specific regulations and guidelines must be observed when planning and designing the installation.

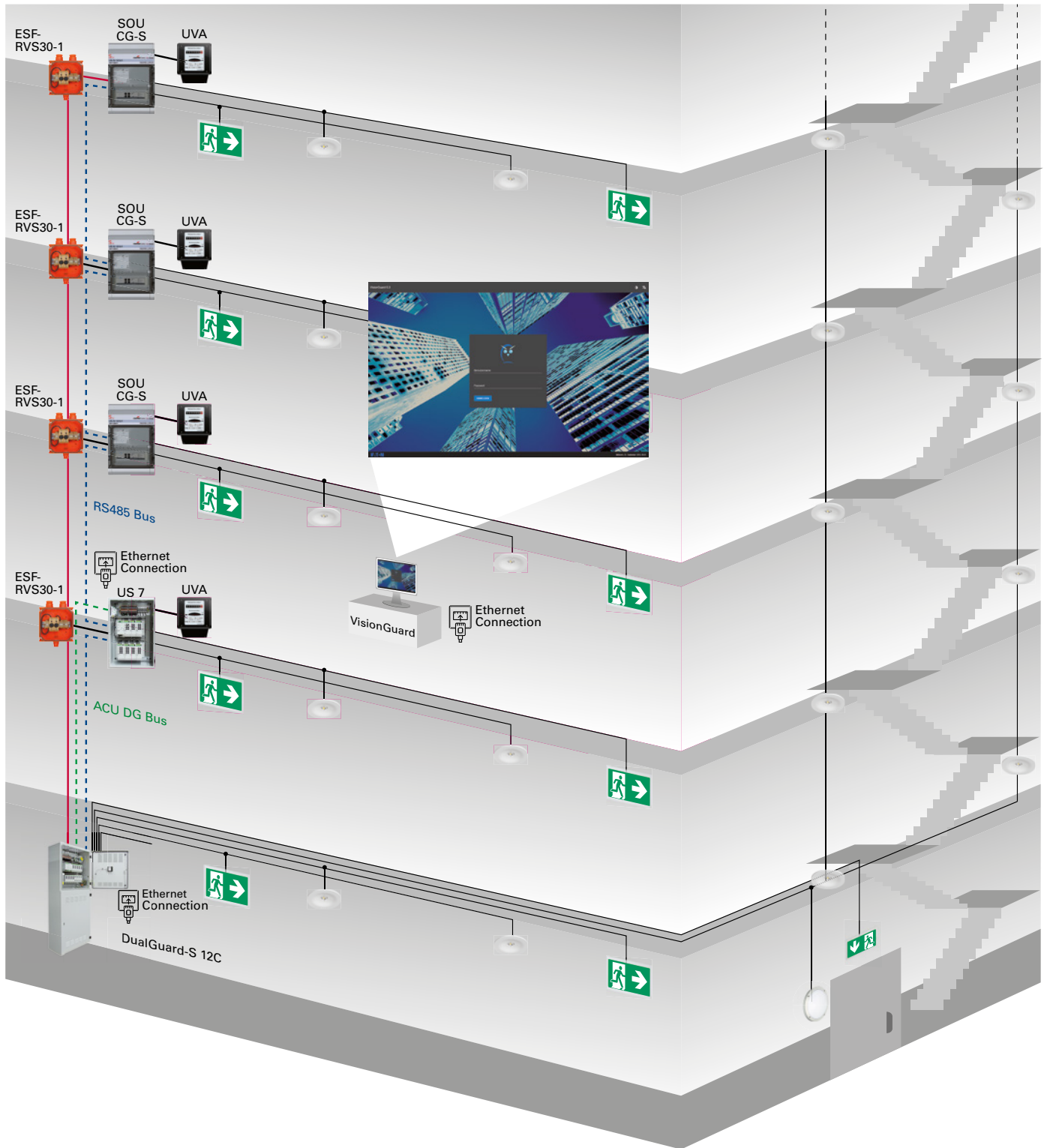

DualGuard-S installation example

DualGuard-S – central battery system

Mains distribution board general lighting

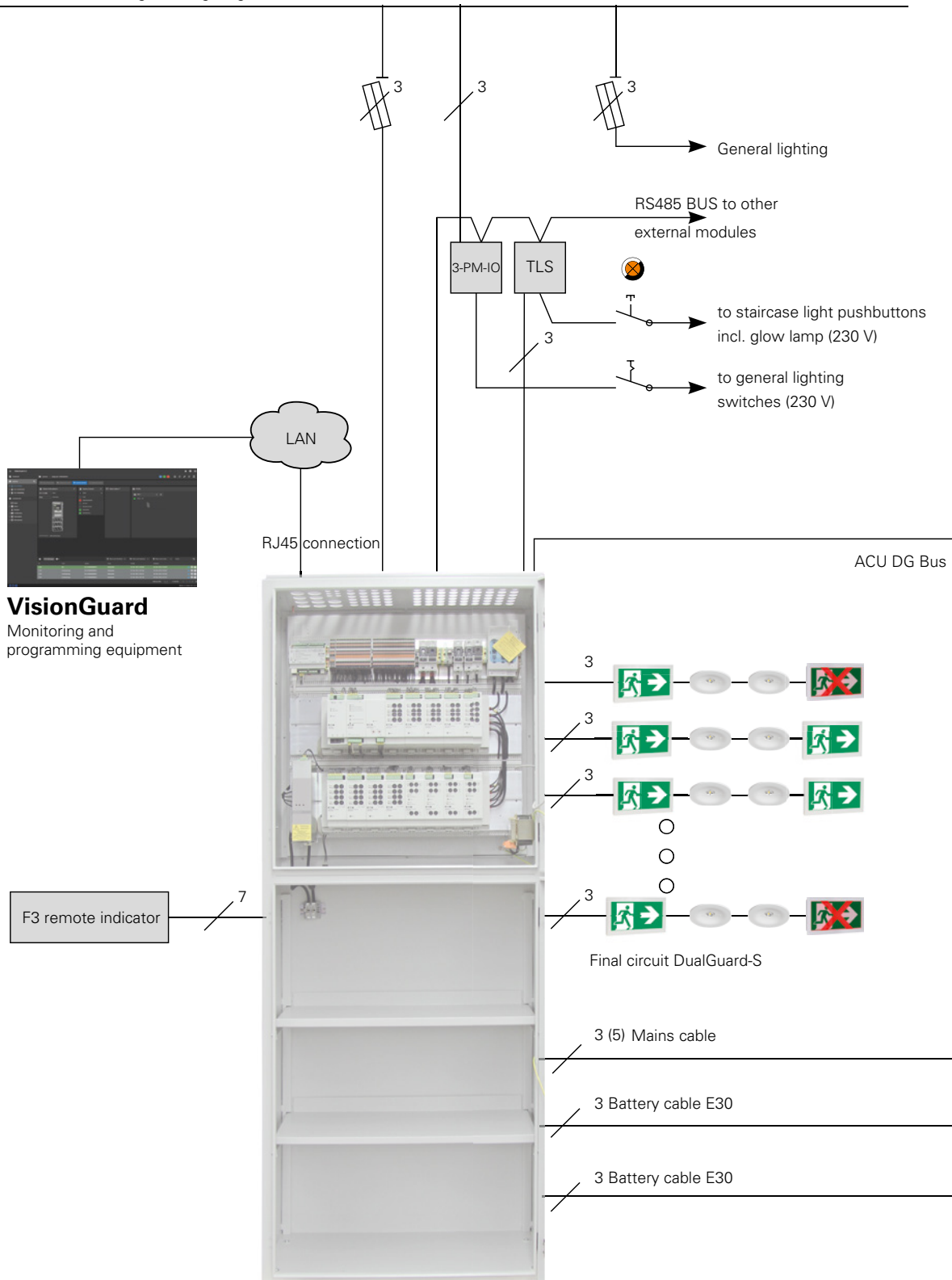

Central battery system DualGuard-S 12C

DualGuard-S installation example

DualGuard-S – central battery system

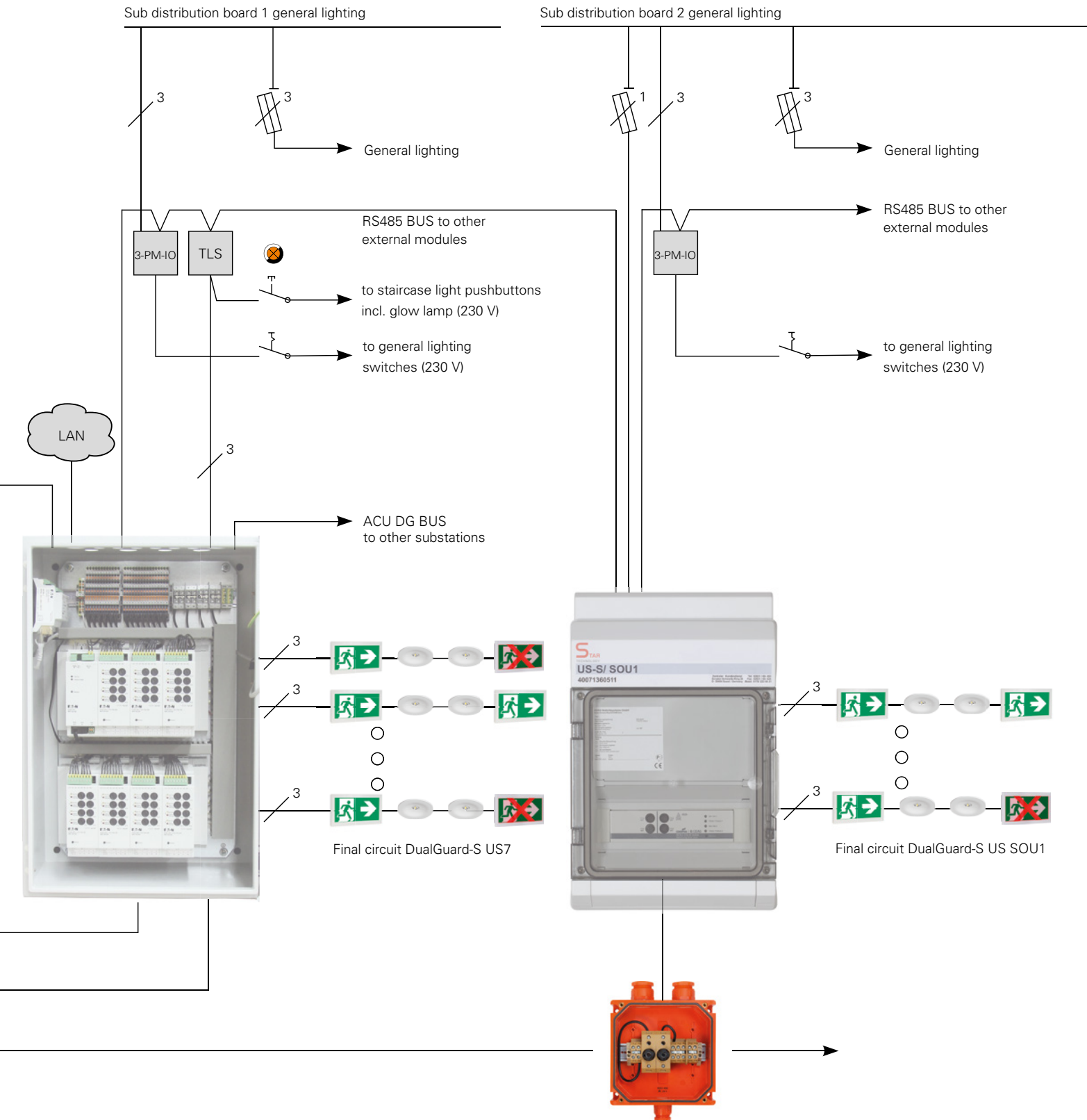

Substation DualGuard-S US7

Substation DualGuard-S US SOU1

Overview of device models

DualGuard-S – central battery system

Overview of new DualGuard-S device models



The objective of the emergency lighting system is to supply the connected safety lighting system in the event of a general power failure in the primary external power supply. An important function of the emergency lighting system is to ensure the permanent operational capability of all the connected security and LED escape sign luminaires via automatic monitoring. Depending on the project requirement, the correct device model can be chosen from the DualGuard-S product family.

The modular design and the pre-assembled cabinet components provide flexibility, charging equipment, switching equipment and monitoring equipment form units that operate independently of one another, so devices are not interdependent.



With DualGuard-S Module exchange and expansion is quick & easy, with snap and click fit, inside the cabinet the module layout is clear and easy to follow.

DualGuard-S 28 or DualGuard-S 20

For operation with a maximum of 28 or 20 SKU.1 CG-S circuit modules with 88 circuit terminals. Up to 6 sub-stations can be supplied with battery power or main power (up to 6 sub-stations 1-phase, up to 2 sub-stations 3-phase).

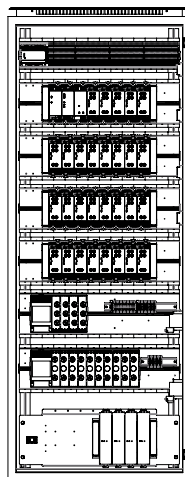

DualGuard-S 28

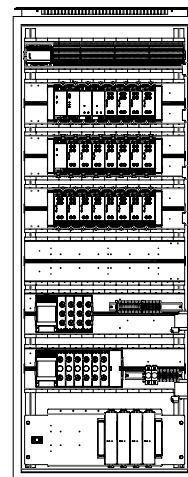

DualGuard-S 20

Order details

Model	Included with delivery	Order no.
DualGuard-S 28	Free-standing cabinet with optimized wiring system for central battery system CEAG DualGuard-S 28, equipped with battery control module (BCM.1), advanced control unit (ACU DG-S) and power supply unit (PSU). For installing a 4.3" or 7" TFT touch display. With extra space for adding a maximum of 88 final circuits, or a maximum of 28 variable circuit boards. Please note! The CM charging modules and the TFT touch display are not part of the cabinet module.	40071362511
DualGuard-S 20	Free-standing cabinet with optimized wiring system for central battery system CEAG DualGuard-S 20, equipped with battery control module (BCM.1), advanced control unit (ACU DG-S) and power supply unit (PSU). For installing a 4.3" or 7" TFT touch display. With extra space for adding a maximum of 88 final circuits, or a maximum of 20 variable circuit boards. Please note! The CM charging modules and the TFT touch display are not part of the cabinet module.	40071362510

DualGuard-S LAD 100

The charging and distribution board supplies up to fifteen 1-phase or five 3-phase sub-stations with mains and battery voltage. In addition, up to four circuit modules can supply and control 16 circuits.

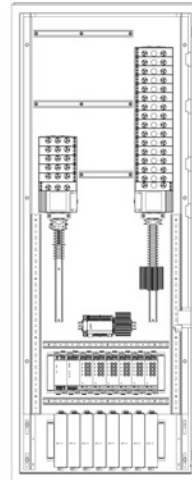

DualGuard-S LAD 100

Order details

Model	Included with delivery	Order no.
DualGuard-S LAD 100	Free-standing cabinet for central battery system CEAG DualGuard-S LAD 100A, equipped with battery control module (BCM.1), advanced control unit (ACU DG-S) and power supply unit (PSU). For installing a 4.3" or 7" TFT touch display. With extra space for adding a maximum of 16 final circuits, or a maximum of 4 variable circuit boards. Please note! The CM charging modules and the TFT touch display are not part of the cabinet module.	40071362540

Overview of device models

DualGuard-S – central battery system

DualGuard-S 12C, DualGuard-S 12C6, DualGuard-S 20C6, DualGuard-S 12C4, DualGuard-S 4C3

For operation with a maximum of 12 or 20 SKU.1 CG-S circuit modules.

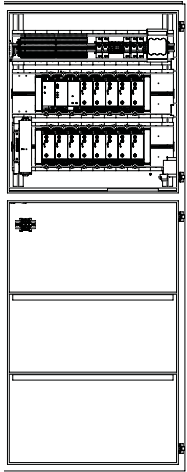

DualGuard-S 12C

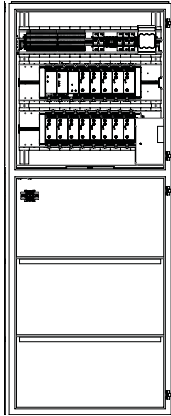

DualGuard-S12C6

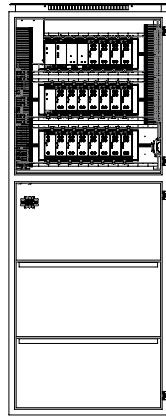

DualGuard-S20C6

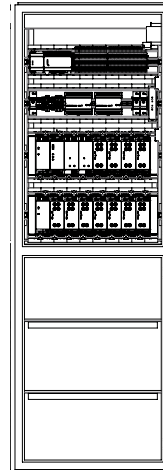

DualGuard-S12C4

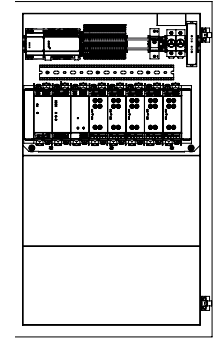

DualGuard-S4C3

Order details

Model	Included with delivery	Order no.
DualGuard-S 12C	Compact cabinet for central battery system CEAG DualGuard-S 12C, equipped with battery control module (BCM.1), advanced control unit (ACU DG-S) and power supply unit (PSU). For installing a 4.3" or 7" TFT touch display. With extra space for adding a maximum of 48 final circuits, or a maximum of 12 variable circuit boards. Please note! The CM charging modules and the TFT touch display are not part of the cabinet module.	40071362520
DualGuard-S12C6	Compact cabinet for central battery system CEAG DualGuard-S 12C6, equipped with battery control module (BCM.1), advanced control unit (ACU DG-S) and power supply unit (PSU). For installing a 4.3" or 7" TFT touch display. With extra space for adding a maximum of 48 final circuits, or a maximum of 12 variable circuit boards. Please note! The CM charging modules and the TFT touch display are not part of the cabinet module.	40071362523
DualGuard-S20C6	Compact cabinet for central battery system CEAG DualGuard-S 20C6, equipped with battery control module (BCM.1), advanced control unit (ACU DG-S) and power supply unit (PSU). For installing a 4.3" or 7" TFT touch display. With extra space for adding a maximum of 68 final circuits, or a maximum of 20 variable circuit boards. Please note! The CM charging modules and the TFT touch display are not part of the cabinet module.	40071362524
DualGuard-S12C4	Compact cabinet for central battery system CEAG DualGuard-S 12C4, equipped with battery control module (BCM.1), advanced control unit (ACU DG-S) and power supply unit (PSU). For installing a 4.3" or 7" TFT touch display. With extra space for adding a maximum of 48 final circuits, or a maximum of 12 variable circuit boards. Please note! The CM charging modules and the TFT touch display are not part of the cabinet module.	40071362521
DualGuard-S4C3	Compact cabinet for central battery system CEAG DualGuard-S 4C3, equipped with battery control module (BCM.1), advanced control unit (ACU DG-S) and power supply unit (PSU). For installing a 4.3" or 7" TFT touch display. With extra space for adding a maximum of 20 final circuits, or a maximum of 4 variable circuit boards. Please note! The CM charging modules and the TFT touch display are not part of the cabinet module.	40071362525

DualGuard-S US 38, US 30, US 23, US 15, US 7

For operation with a maximum of 7, 15, 23, 30 or 38 SKU.1 CG-S circuit modules. Charging technology for connected battery emergency power supply not included for these sub-stations; battery and mains power supply takes place via the DualGuard-S system.

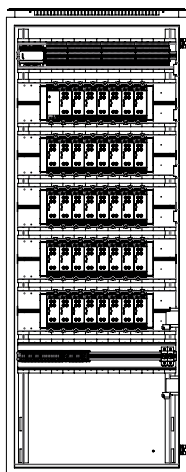

DualGuard-S US 38

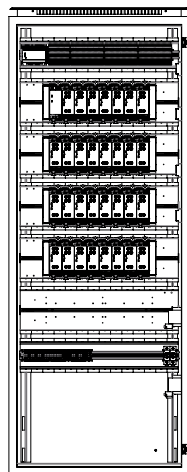

DualGuard-S US 30

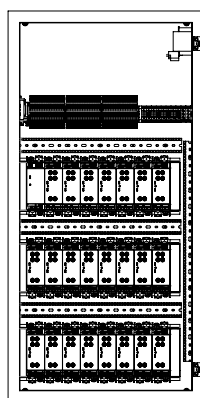

DualGuard-S US 23

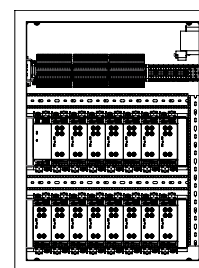

DualGuard-S US 15

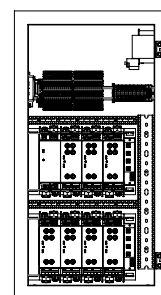

DualGuard-S US 7

Order details

Model	Included with delivery	Order no.
DualGuard-S US 38	Free-standing cabinet for sub-stations CEAG DualGuard-S US-S 38, equipped with advanced control unit (ACU DG-S) and power supply unit (PSU). For installing a 4.3" or 7" TFT touch display. With extra space for adding a maximum of 88 final circuits, or a maximum of 38 variable circuit boards. Please note! The TFT touch display is not part of the cabinet module.	40071362513
DualGuard-S US 30	Free-standing cabinet for sub-stations CEAG DualGuard-S US-S 30, equipped with advanced control unit (ACU DG-S) and power supply unit (PSU). For installing a 4.3" or 7" TFT touch display. With extra space for adding a maximum of 88 final circuits, or a maximum of 30 variable circuit boards. Please note! The TFT touch display is not part of the cabinet module.	40071362512
DualGuard-S US 23	Wall cabinet for CEAG DualGuard-S US-S 23 sub-stations, equipped with advanced control unit (ACU DG-S) and power supply unit (PSU). For installing a 4.3" or 7" TFT touch display. With extra space for adding a maximum of 52 final circuits, or a maximum of 23 variable circuit boards. Please note! The TFT touch display is not part of the cabinet module.	40071362532
DualGuard-S US 15	Wall cabinet for CEAG DualGuard-S US-S 15 sub-stations, equipped with advanced control unit (ACU DG-S) and power supply unit (PSU). For installing a 4.3" or 7" TFT touch display. With extra space for adding a maximum of 32 final circuits, or a maximum of 15 variable circuit boards. Please note! The TFT touch display is not part of the cabinet module.	40071362531
DualGuard-S US 7	Wall cabinet for CEAG DualGuard-S/US-S 7 sub-stations, equipped with advanced control unit (ACU DG-S) and power supply unit (PSU). For installing a 4.3" or 7" TFT touch display. With extra space for adding a maximum of 28 final circuits, or a maximum of 7 variable circuit boards. Please note! The TFT touch display is not part of the cabinet module.	40071362530

Overview of device models

DualGuard-S – central battery system

DualGuard-S US SOU2, US SOU1

For operation with a maximum of 1 or 2 SOU CG-S circuit switching modules. TFT touch display not included for these sub-stations. Battery power supplied via the DualGuard-S system; mains power supplied via the sub-distributor for the general power supply (rental current infeed).

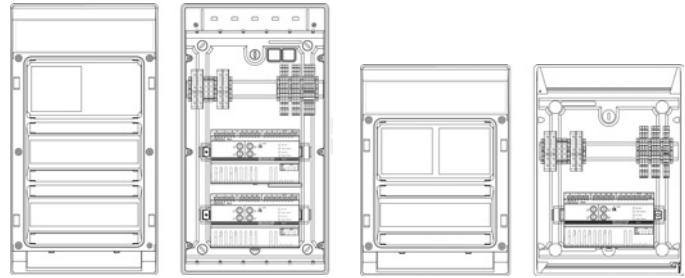

DualGuard-S US SOU2

DualGuard-S US SOU1

Order details

Model	Included with delivery	Order no.
DualGuard-S US SOU2	Small distribution board for DualGuard-S/US-S SOU2 sub-stations, equipped with two SOU CG-S 2x4A circuit modules	40071362519
DualGuard-S US SOU1	Small distribution board for DualGuard-S/US-S SOU1 sub-stations, equipped with one SOU CG-S 2x4A circuit module	40071362518

DualGuard-S ESF15-P, ESF30-P

Electrical distributor with 30 minutes of functional integrity in the event of fire for operation with a maximum of 15 or 30 SKU.1 CG-S circuit modules.

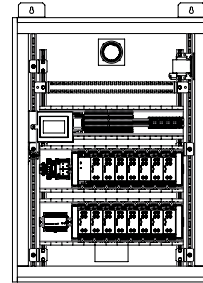

DualGuard-S ESF30 15-P

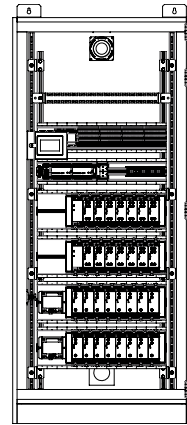

DualGuard-S ESF30 30-P

Order details

Model	Included with delivery	Order no.
DualGuard-S ESF30 15-P	Wall cabinet for sub-stations with 30 minutes of functional integrity during fire from outside CEAG DualGuard-S ESF30 15-P, equipped with 4.3" TFT touch display, advanced control unit (ACU DG-S) and power supply unit (PSU). With extra space for adding a maximum of 40 final circuits, or a maximum of 15 variable circuit boards.	40071362516
DualGuard-S ESF30 30-P	Free-standing cabinet for sub-stations with 30 minutes of functional integrity during fire from outside CEAG DualGuard-S ESF30 30-P, equipped with 4.3" TFT touch display, advanced control unit (ACU DG-S) and power supply unit (PSU). With extra space for adding a maximum of 58 final circuits, or a maximum of 30 variable circuit boards.	40071362517

DualGuard-S ESF SOU5, ESF SOU3, ESF SOU2, ESF SOU1

Electric distributor with 30 minutes of functionality in the event of fire for operation with a maximum of 5, 3, 2, 1 SOU CG-S 2 x 4A circuit switching modules.

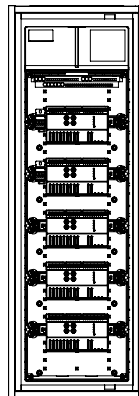

DualGuard-S ESF30 SOU5

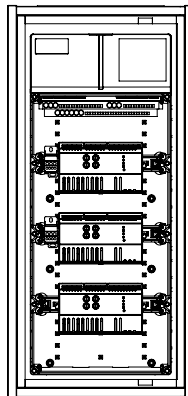

DualGuard-S ESF30 SOU3

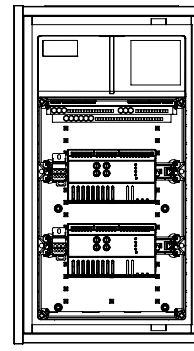

DualGuard-S ESF30 SOU2

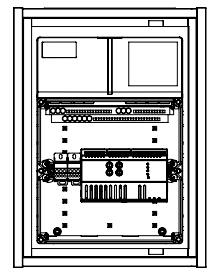

DualGuard-S ESF30 SOU1

Order details

Model	Included with delivery	Order no.
DualGuard-S ESF30 SOU5	Wall cabinet for sub-stations with 30 minutes of functional integrity during fire from the outside DualGuard-S ESF30 SOU5, equipped with five SOU CG-S 2x4A circuit modules	40071362538
DualGuard-S ESF30 SOU3	Wall cabinet for sub-stations with 30 minutes of functional integrity during fire from outside DualGuard-S ESF30 SOU3, equipped with three SOU CG-S 2x4A circuit modules	40071362537
DualGuard-S ESF30 SOU2	Wall cabinet for sub-stations with 30 minutes of functional integrity during fire from the outside DualGuard-S ESF30 SOU2, equipped with two SOU CG-S 2x4A circuit modules	40071362536
DualGuard-S ESF30 SOU1	Wall cabinet for sub-stations with 30 minutes of functional integrity during fire from the outside DualGuard-S ESF30 SOU1, equipped with one SOU CG-S 2x4A circuit module	40071362535

TFT touch display 4.3" and 7"

DualGuard-S – central battery system

TFT touch display 4.3" and 7"



TFT touch display 4.3" and 7"

- Dimmable TFT touch display with 64k colours and 250 cd/m² light density
- Touch function across the entire operating surface
- Multi-colour icons for status displays, operation and programming
- High performance 32-bit processor, 512MB Ram, 4GB Flash
- Start screen with all essential system information for servicing, technical acceptance, initial operation and maintenance at a glance
- Intuitive menu navigation through operating levels for initial operation, configuration, programming and servicing
- Eaton's cyber security for password protection, web access and connectivity
- All operating texts and status information in 19 different languages
- Customer-specific texts can be entered on-site
- USB 2.0 host for use in transmitting data during start-up, configuration modifications, log book and software updates
- Web connection available as standard equipment
- IP65 – Meets the highest standards in terms of quality and service life
- Meets all EMV requirements for industrial and commercial use
- DEKRA system certification documents product quality and compliance with standards for the entire system
- Functionality for 30 minutes in the event of fire verified in a fire test conducted by an independent materials testing institute
- Conforms to RoHS and REACH

Protection class, external	IP65
Ambient temperature range	0 – 50°C
Electromagnetic compatibility	Industrial EN 61000-6-2, Commercial EN 61000-6-3
Relative humidity	10 – 95%, non-condensing
Pollution level	2
Max. power consumption	9.5W

Order details

Model	Included with delivery	Order no.
HMI module 4.3" SP	4.3" TFT touch display for door installation	40071361644
HMI module 7" SP	7" TFT touch display for door installation	40071361654

ACU DG-S module



ACU DG-S module

- Compact DIN bars installation
- Dual assignable screw terminals for conductors with the same diameter
- Integrated, switchable bus terminal resistors
- Six freely configurable short-circuit/interruption-tolerant 24V inputs
- Four configurable potential-free signal contacts with separate roots
- Two configurable 24V CD outputs for additional relays
- Colour LED indicators for ready status, battery mode, malfunction and scenario active
- Innovative, transmission-safe ACU DG-S bus communication
- Automatic activation of safety lighting following interruption of bus communication
- Functional upon activation of battery deep discharge protection or HMI outage
- Meets all EMV requirements for industrial and commercial use
- DEKRA system certification documents product quality and compliance with standards for the entire system
- Functionality for 30 minutes in the event of fire verified in a fire test conducted by an independent materials testing institute
- Conforms to RoHS and REACH

Degree of protection	IP20
Protection class	II
Ambient temperature range	-5°C – +55°C
Relative humidity	10 – 95%, non-condensing
Electromagnetic compatibility	Industrial EN 61000-6-2, Commercial EN 61000-6-3
Max. pollution level	2
Overvoltage category	II for battery circuit
Power consumption	2 W

Order details

Model	Included with delivery	Order no.
ACU DG-S module	Control module for top-hat rail installation	40071361600

Wiring diagram: ACU Bus – X2.A	
Rated voltage	≤ 30V (SELV)
Rated current	≤ 0.09A short-circuit-proof
Bus topology	Line
Cable type	such as IY(ST)Y 4x2x0.8 mm
Maximum cable length	900 m
Terminating resistor	Switchable via DIL switch on ACU DG-S.
Maximum number of DualGuard-S systems	32

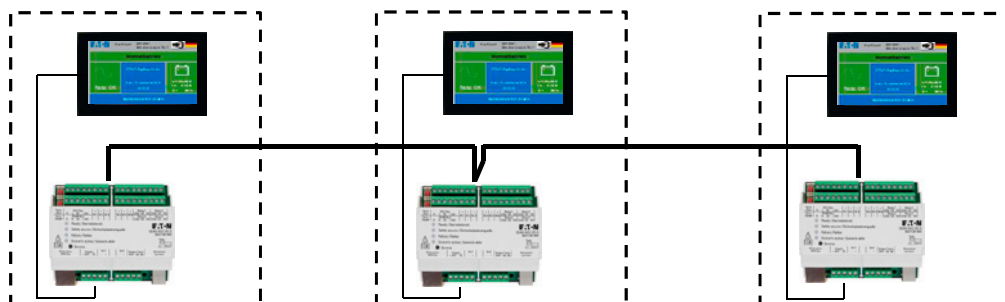

PSU module

DualGuard-S – central battery system

PSU module



PSU module

- Intelligent, automatic bus alarm management in the event of a fault or exceeding limit values
- Expanded DC input voltage range from 173-330V
- Expanded temperature range from 0°C...+55°C
- Maintenance-free, passive ventilation
- Output voltage indication provided by three LEDs
- Outputs switchable in parallel with automatic power control
- Wide finger-safe ventilation slits for optimum heat dissipation
- Simple, time-saving snap on click installation on device rack
- Meets all EMV requirements for industrial and commercial use
- The DEKRA system certification documents product quality and compliance with standards
- Functionality for 30 minutes in the event of fire verified in a fire test conducted by an independent materials testing institute
- Conforms to RoHS and REACH

Degree of protection	IP20
Protection class	II
Ambient temperature range	0°C – +55°C
Relative humidity	10% – 95%, non-condensing
Air pressure	795...1080 hPa
Height	≤ 2000 m
Pollution level	2

Order details

Model	Included with delivery	Order no.
PSU module	Power supply module for component rack installation	40071361590

AC trafo

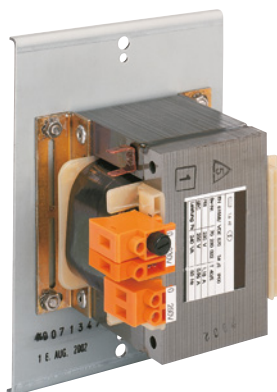

AC trafo

- For mains supply to internal modules
- DEKRA system certification documents product quality and compliance with standards for the entire system
- Functionality for 30 minutes in the event of fire verified in a fire test conducted by an independent materials testing institute
- Conforms to with RoHS and REACH

Degree of protection	IP20
Protection class	II
Ambient temperature range	0°C – +55°C
Relative humidity	10% – 95%, non-condensing
Air pressure	795...1080 hPa
Height	≤ 2000 m
Pollution level	2

Order details

Model	Included with delivery	Order no.
AC trafo	Transformer module AC/AC converter 240VA including mounting adapter for top hat rail installation	40071347162

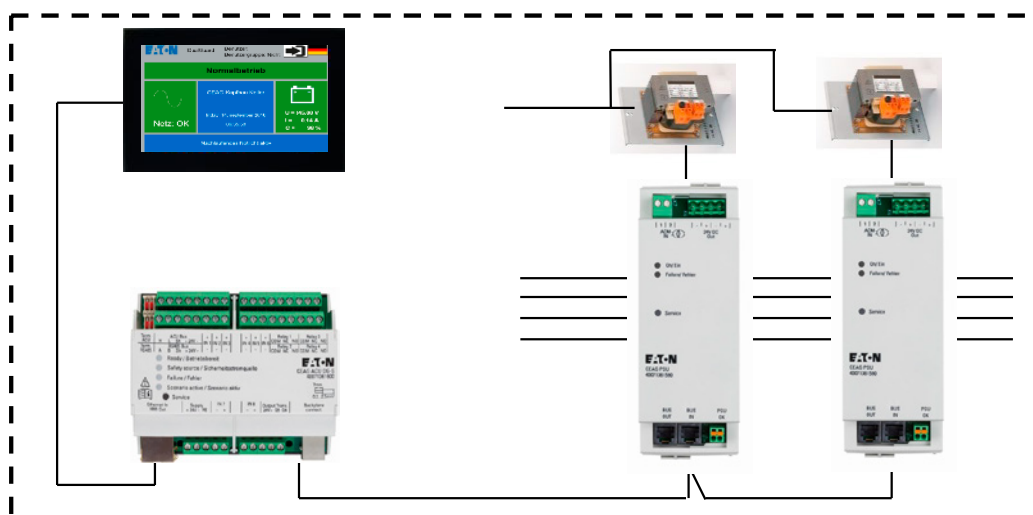

BCM.1 module

DualGuard-S – central battery system

BCM.1 module



BCM.1 module

- Automated monitoring of up to four battery arrays
- Temperature-controlled charging control of up to 32 charging modules
- Automated monitoring of each charging module via the CCB bus with individual error warnings via the TFT touch display
- LED display indicating ready, boost charge, charging malfunction and insulation defect
- Individual indication of isolation faults per circuit
- Automatic monitoring of isolation measuring device
- Alternating charging regulation during trickle charging and more than one charging module
- Relay contacts for forwarding of disruption, boost charging and insulation defect
- All module connections are wired to a three level tension spring installation terminal
- Simple, time saving snap on click installation on device rack
- Meets all EMV requirements for industrial and commercial use
- DEKRA system certification documents product quality and compliance with standards for the entire system
- Conforms to RoHS and REACH

Degree of protection	IP20
Protection class	II
Ambient temperature range	-5°C – +55°C
Relative humidity	10% – 95%, non-condensing
Air pressure	795... 1080 hPa
Pollution level	2
Electromagnetic compatibility	Industrial EN 61000-6-2, Commercial EN 61000-6-3

Order details

Model	Included with delivery	Order no.
BCM.1 module	Battery control module for component rack installation	40071361540

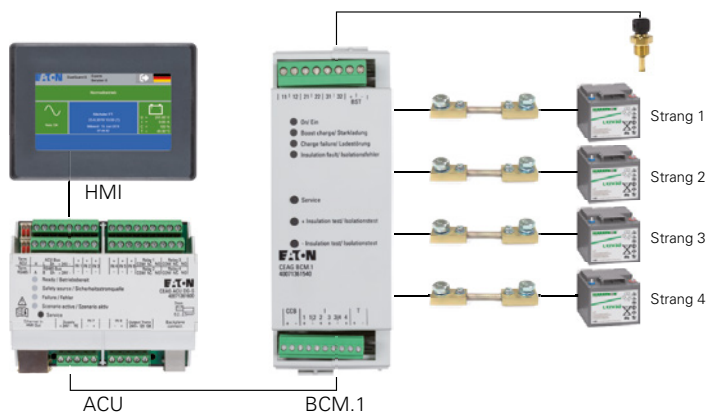
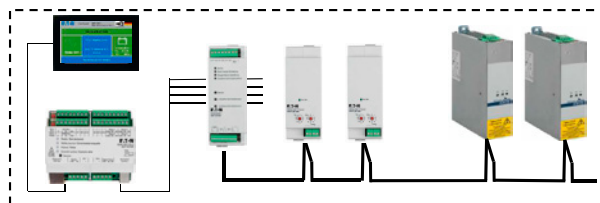

CM.1 1.7A charging module



CM.1 1.7 A charging module

- Efficient operation by means of alternating activation/deactivation of trickle charge
- Optimum performance through a combination of charging modules 1.7A and 3.4A
- Automated monitoring and temperature dependent charging regulation through the BCM.1 module and the CCB bus connection
- Automated deactivation of boost charging during outage of room ventilation system
- LED indicator of ready status/malfunction
- Wide finger-safe ventilation slits for optimum heat dissipation
- Simple, time saving snap on click installation on device rack
- Meets all EMV requirements for industrial and commercial use
- DEKRA system certification documents product quality and compliance with standards for the entire system
- Conforms to RoHS and REACH

Degree of protection	IP20
Protection class	II
Ambient temperature range	0°C – +55°C
Relative humidity	10% – 95%, non-condensing
Air pressure	795...1080 hPa
Pollution level	2
Electromagnetic compatibility	Industrial EN 61000-6-2, Commercial EN 61000-6-3

Order details

Model	Included with delivery	Order no.
CM.1 1.7A	1.7A charging module for component rack installation	40071361580

CM 3.4A charging module



CM 3.4A charging module

- Efficient operation by means of alternating activation/deactivation of trickle charge
- Optimum performance through a combination of 1.7A and 3.4A charging modules
- Automated monitoring and temperature-dependent charging regulation through the BCM.1 module and the CCB bus connection
- Automated deactivation of boost charging during outage of room ventilation system
- LED indicator of ready status/malfunction
- Meets all EMV requirements for industrial and commercial use
- DEKRA system certification documents product quality and compliance with standards for the entire system
- Conforms to RoHS and REACH

Degree of protection:	IP20
Protection class:	I
Ambient temperature:	0°C – +55°C
Relative humidity:	10% – 95%, non-condensing
Air pressure:	795...1080 hPa
Pollution level:	2
Electromagnetic compatibility	Industrial EN 61000-6-2, Commercial EN 61000-6-3

Order details

Model	Included with delivery	Order no.
CM 3.4A	3.4A charging module for component rack installation	40071360370

SKU.1 CG-S 4x1.5A circuit switching

DualGuard-S – central battery system

SKU.1 CG-S 4x1.5A



SKU.1 CG-S 4x1.5A

- CG technology provides for automatic monitoring of up to 20 safety lights and emergency signs without requiring the transmission of additional data for each circuit
- Overload indicator
- Programmable switching for each individual light with no need to make adjustment directly to the luminaire itself
- Automated isolation fault finding
- Assemblies use service friendly module technology, wired ready for connection to triple-deck 4 mm² neutral terminals
- Large finger safe ventilation slits for optimum heat dissipation
- Simple, time saving snap on click installation on device rack
- Wide sign racks for Customised labeling
- Meets all EMV requirements for industrial and commercial use
- DEKRA system certification documents product quality and compliance with standards for the entire system
- Functionality for 30 minutes during fire verified in a fire test conducted by an independent materials testing institute
- Conforms to RoHS and REACH

Inputs

Nominal AC voltage	220-240V
Nominal DC voltage	184-275V
Rated frequency	50 or 60 Hz
Maximum head dissipation capacity:	8W

Outputs

Rated current	1.5A
short-circuit current	1500A
Inrush current	60A per circuit/240A per module

Order details

Model	Included with delivery	Order no.
SKU.1 CG-S 4 x 1.5A	Circuit switching 4 x 1.5A for component rack installation	40071361550

SKU.1 CG-S 2x3A



SKU.1 CG-S 2x3A

- CG technology provides for automatic monitoring of up to 20 safety lights and emergency signs without requiring the transmission of additional data for each circuit
- Overload indicator
- Programmable switching for each individual light with no need to make adjustment directly to the luminaire itself
- Automated isolation fault finding
- Assemblies use service friendly module technology, wired ready for connection to triple-deck 4 mm² neutral terminals
- Wide finger safe ventilation slits for optimum heat dissipation
- Simple, time saving snap on click installation on device rack
- Large sign rack for Customised labeling
- Meets all EMV requirements for industrial and commercial use
- DEKRA system certification documents product quality and compliance with standards for the entire system
- Functionality for 30 minutes during fire verified in a fire test conducted by an independent materials testing institute
- Conforms to RoHS and REACH

Nominal AC voltage	220-240V
Nominal DC voltage	184-275V
Rated frequency	50 or 60 Hz
Maximum head dissipation capacity	4 W
Outputs	
Rated current	3A
short-circuit current	1500A
Inrush current	250A per circuit

Order details

Model	Included with delivery	Order no.
SKU.1 CG-S 2 x 3A	Circuit switching 2 x 3A for component rack installation	40071361560

SKU.1 CG-S 1x6A circuit switching

DualGuard-S – central battery system

SKU.1 CG-S 1x6A



SKU.1 CG-S 1x6A

- CG technology provides for automatic monitoring of up to 20 safety lights and emergency signs without requiring the transmission of additional data
- Overload indicator
- Programmable switching for each individual light with no need to make adjustment directly to the luminaire itself
- Automated isolation fault finding
- Assemblies use service-friendly module technology, wired ready for connection to triple deck 4 mm² neutral terminals
- Wide finger safe ventilation slits for optimum heat dissipation
- Simple, time saving snap on click installation on device rack
- Large sign rack for Customised labeling
- Meets all EMV requirements for industrial and commercial use
- DEKRA system certification documents product quality and compliance with standards for the entire system
- Functionality for 30 minutes during fire verified in a fire test conducted by an independent materials testing institute
- Conforms to RoHS and REACH

Inputs

Nominal AC voltage	220-240V
Nominal DC voltage	184-275V
Rated frequency	50 or 60 Hz
Maximum head dissipation capacity:	4 W
Output nominal current	6A
short-circuit current	1500A
Inrush current	250A

Order details

Model	Included with delivery	Order no.
SKU.1 CG-S 1 x 6A	Circuit switching 1 x 6A for component rack installation	40071361570

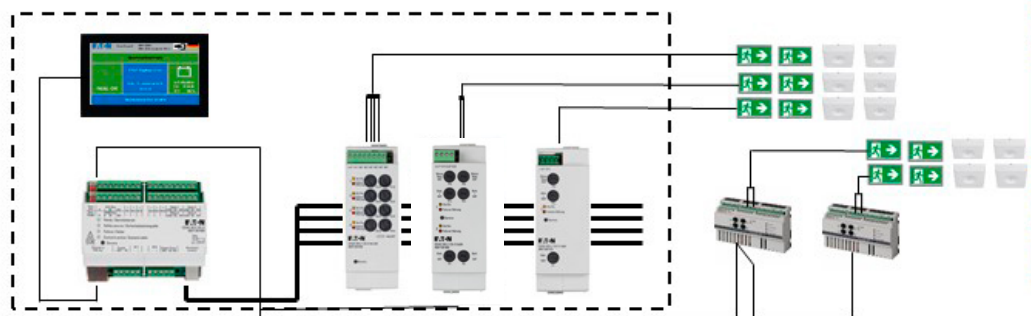

SOU CG-S 2x4A



SOU CG-S 2x4 A

- Separate rental current feed in
- CG technology provides for automatic monitoring of up to 20 safety lights and emergency signs without requiring the transmission of additional data for each circuit
- Overload indicator
- Programmable switching for each individual light with no need to make adjustment directly to the luminaire itself
- Automated isolation fault finding
- Dual assignable screw terminals for conductors with the same diameter
- All module connections are wired to a triple deck tension spring installation terminal
- Large sign rack for Customised labeling
- Meets all EMV requirements for industrial and commercial use
- DEKRA system certification documents product quality and compliance with standards for the entire system
- Functionality for 30 minutes during fire verified in a fire test conducted by an independent materials testing institute

Inputs

Nominal AC voltage	220-240V
Nominal DC voltage	184-275V
Rated frequency	50/60 Hz
Maximum head dissipation capacity:	9 W
Short-circuit current per circuit	1500A
Inrush current	250A per circuit

Order details

Model	Included with delivery	Order no.
SOU CG-S 2 x 4A	Circuit switching 2 x 4A for top-hat rail installation	40071360430

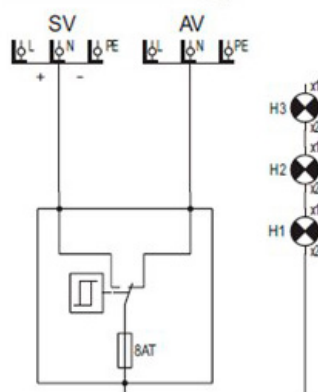

CG IV.1 relay module

DualGuard-S – central battery system

CG IV.1 relay module

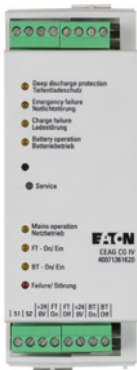

CG IV.1 relay module

This module allows for connection of the central battery system to a central control station. Status of key systems reported via potential-free signal contacts. Two input channels available for remote inspection of the central battery system. A function test can be launched via the “FT” input channel, and a duration test (battery test) can be launched via the “BT” input channel. Eight LEDs indicate system status.

Inputs

Nominal AC voltage	220-240V
Nominal DC voltage	184-275V
Rated frequency	50 Hz

Outputs

Rated current/voltage	0.65A/24V
-----------------------	-----------

Order details

Model	Included with delivery	Order no.
CG IV.1	Relay module for component rack installation	40071361620

CG V.1 relay module



CG V.1 relay module

This module allows for connection of the central battery system to a building control system. Status of key systems reported via potential-free signal contacts. Two input channels available for remote inspection of the central battery system. A function test can be launched via the “FT” input channel, and a duration test (battery test) can be launched via the “BT” input channel. Eight LEDs indicate system status.

Inputs	
Nominal AC voltage	220-240V
Nominal DC voltage	184-275V
Rated frequency	50 Hz
Outputs	
Rated current/voltage	0.65A/24V

Order details

Model	Included with delivery	Order no.
CG V.1	Relay module for component rack installation	40071361630

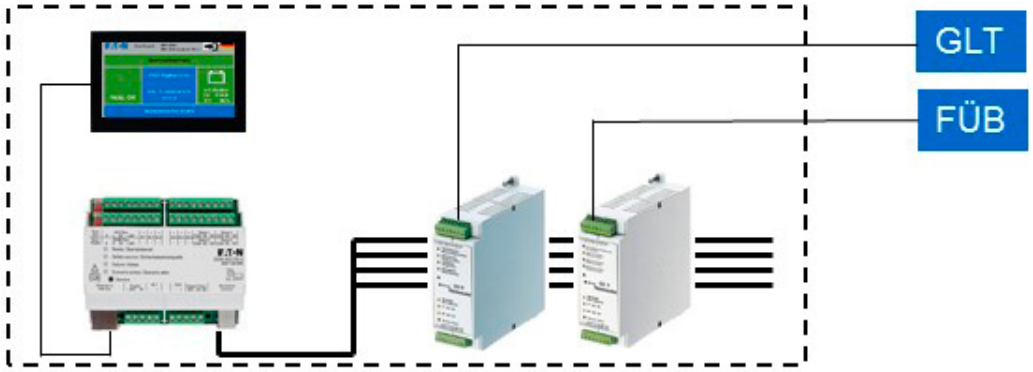

RCM-A remote indication

DualGuard-S – central battery system

RCM-AR flush-mounted



RCM-AS surface-mounted



RCM-A remote indication

The RCM-A remote display uses a battery power supply to display the the most important system functions safely. A key operated switch can be used to block emergency lighting operation during periods of inactivity. The remote indicator thus fulfils the requirement that remote switching is only permissible if actuation by Unauthorised persons are not possible. By blocking the emergency operation, the battery maintenance charge is not affected. A differential loop monitoring leads to Short circuit or open circuit detection to make the system ready for operation. LED indicators: System operational, power source for safety purposes, error.

	RCM-AS surface-mounted	RCM-AR flush-mounted
Mechanic		
Dimensions (W x H x D mm)	80 x 80 x 52	80 x 80 x 12 (without flush-mounted box) Diameter flush-mounted box: 70 mm Deep flush-mounted box: 64 mm
Weight	0.15 kg	0.16 kg
Degree of protection	IP 20	IP 20
Material	Thermoplast	
Resistant up to Flammability	650°C	
Environment		
Ambient temperature	-5°C ... +35°C	
Storage temperature	-20°C ... +65°C	
Relative humidity	10% ... 95% no condensation	
Air pressure	795 ... 1080 hPa	
EMC		
Interference immunity	EN/IEC 61000-6-2	
Interference radiation	EN/IEC 61000-6-3	
Electrical parameters		
Rated voltage	24 V DC (SELV)	
Degree of pollution	2	
Power consumption	< 1 W	
Installation		
Lead	J-Y(ST)Y 4 x 2 x 0.8	
Max. Cable length	2000 m	

Ordering details

Type	Scope of supply	Order No.
RCM-AS remote indication	Subassembly for wall mounting	40071362390
RCM-AR remote indication flush-mounted	Component for installation in switch or cavity wall	40071362395

3-PM module



3-PM voltage monitoring module

To avoid hazards from mains power outages, the functionality of the light distributors for the general lighting must be continuously monitored in order to turn on safety lighting in the event of a disruption. Consequently, CEAG 3-PM modules are an important element of safety systems.

In the event of a phase outage, the CEAG 3-PM module switches a relay contact and interrupts the 24V current loop to the emergency lighting devices. All safety lights set to non-maintained mode are switched to maintained lighting. A second relay contact is used to signal the power failure.

- Test button for a mains emergency light fault, so there is no need to interrupt mains voltage and, therefore, no disruptions to operations in progress
- No E30 wiring by virtue of short circuit/interruption tolerant communication. This results in significantly simpler installation and cost savings.
- Does not require that main power to general lighting be shut off during weekly function testing by virtue of simple manual testing of the circuit monitoring function via the test button. This avoids the disruption of operations in progress as well as the resulting costs thereof
- Automatic record keeping in inspection log. The documentation requirements for safety equipment are thus satisfied
- Meets all EMV requirements for industrial and commercial use
- DEKRA system certification documents product quality and compliance with standards for the entire system

Dimensions in mm (W x H x D)	85 x 52.5 x 65/3 TE
Enclosure	Plastic, light gray
Terminals	2.5 mm ² rigid and flexible
Mounting type	On DIN support rails
Contact	0.5A/24V AC/DC, 1 x normally open, 1 x change-over contact
Threshold	U < 85 % UN

Order details

Model	Included with delivery	Order no.
CEAG 3-PM module with test button	Circuit monitor module for top-hat rail installation	40071361660

3-PM-IO module

DualGuard-S – central battery system

CEAG 3-PM-IO module

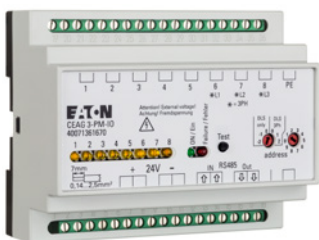

CEAG 3-PM-IO-INV module



External CEAG 3-PM-IO and CEAG 3-PM-IO-INV module

To avoid hazards from mains power outages, the functionality of the light distributors for the general lighting must be continuously monitored in order to turn on safety lighting in the event of a disruption. Consequently, the CEAG 3-PM-IO and CEAG 3-PM-IO-INV modules are an important element of the safety system.

- Test button for mains emergency light fault, so there is no need to interrupt mains voltage and, therefore, no disruptions to operations in progress
- 3-PM-IO module: Eight measurement inputs for monitoring up to three phases and up to five * light switches
- 3-PM-IO-INV module: Eight inverted measurement inputs for monitoring up to three phases and up to five* light switches
- Programmable allocation of CEAG 3-PM-IO and CEAG 3-PM-IO-INV modules
- Meets the requirements of future standards. Reduces the risk of cost incurred from retrofitting
- No E30 wiring by virtue of short circuit/interruption-tolerant communication. This results in significantly simpler installation and cost savings.
- Does not require that mains power to general lighting be shut off during weekly function testing by virtue of simple manual testing of the circuit monitoring function via the test button. This avoids the disruption of operations in progress and the resulting costs thereof
- Automatic record keeping in inspection log. The documentation requirements for safety equipment are thus satisfied
- Meets all EMV requirements for industrial and commercial use
- DEKRA system certification documents product quality and compliance with standards for the entire system
- Functionality for 30 minutes during fire verified in a fire test conducted by an independent materials testing institute

* If the phase monitoring function is not required, all eight measuring inputs can be used for the light switch query

	CEAG 3-PM-IO	CEAG 3-PM-IO-INV
Rated voltage of device	24V DC (min. 19V, max. 30V)	
Current consumption (all 8 channels connected)	20 mA ± 5 mA	
Degree of protection	IP20	
Protection class	I	
Ambient temperature range	-10° – +40°C.	
Input channels 8	8 (potential separated $U_N = 230V$)	8 (potential separated $U_N = 230V$)
3-PM (channel 1–8)	3-PM (chan. 1–8) > 195V-> ON	3-PM (chan. 1–8) < 195V-> OFF
3-PH (channel 1–5)	< 138V-> OFF	> 138V-> ON
Data bus/address range	RS 485/1-25	
Weight	0.2 kg	
Dimensions (L x W x H) mm	105 x 85 x 60	
Assembly	DIN rail	
Terminals	2.5 mm ² rigid and flexible	

Order details

Model	Included with delivery	Order no.
CEAG 3-PM-IO module with test button	Module for DIN support rail installation	40071361670
CEAG 3-PM-IO-INV module with test button	Module for DIN support rail installation with inverted input logic	40071361680
DIN support rails	4 DIN support rails for mounting external modules in the switch cabinet including mounting material	40071347125

TLS bus module

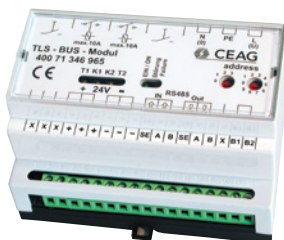

TLS bus module

This module for installation in general lighting distribution boxes monitors the switching status of buttons for up to two separate stairwell luminaires and transmits the respective switching status to the ACU DG-S module of the DualGuard-S system via an RS485 bus line. In mains and emergency operation, the circuits of the stairwell and emergency lights are operated in accordance with the settings for the CU CG-S control unit. In addition, the switch glow lamps of the connected buttons are supplied in mains and emergency lighting mode.

Power supply for the modules

Connection voltage	24V DC (19 ... max. 30V)
Cable type (minimum requirement)	4 x 2 x 0.8 mm IY(ST)Y, twisted pair shielded
Current consumption (minimum requirement)	Max. 50mA, depending on the number of glow lamps for stairwell light switches
Bus connection (minimum requirement)	RS 485, Rated voltage: $U_n = 24V$ DC Type of cable: 4 x 2 x 0.8 mm IY(ST)Y, twisted pair shielded
Connection terminal A, B, SE	
Switch outputs	2 rated voltage $U_r = 230V$, switching current: max. 10A (120A/ms)
Safety class/type	IP20/I
Ambient temp.	-10 ... +40° C
Indicator LEDs:	<ul style="list-style-type: none"> - LED K1 or K2 illuminate when the circuit is closed - LED T1 and T2 illuminate as long as the corresponding button input is activated - LED on/off lit if 24 V DC supply voltage is present and the device is activated via the control - LED fault/failure illuminates if a malfunction has been registered in the module

Order details

Model	Included with delivery	Order no.
TLS.1 module	Stairwell light switch module for top-hat rail installation	40071361720

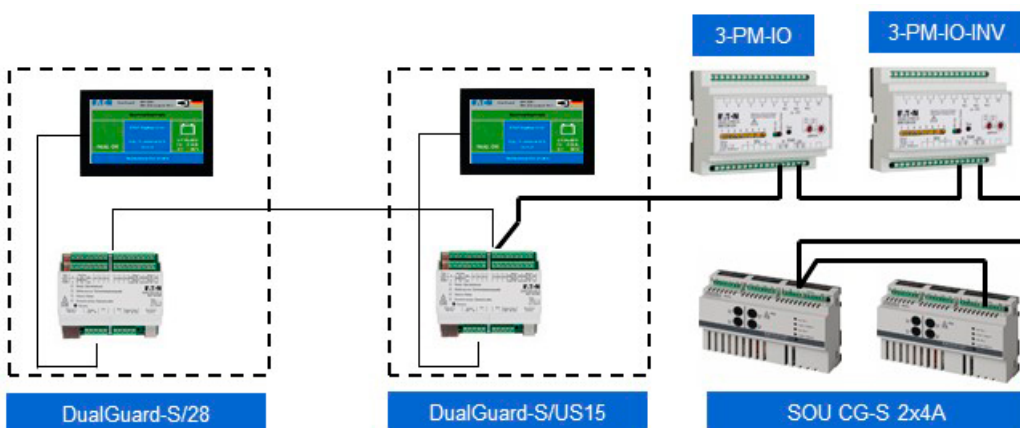

BDM battery data module

DualGuard-S – central battery system

BDM

BDM battery data module



The CEAG BDM battery data module automatically records voltage and temperature values during initial operation and recurring tests. In addition, the battery block monitoring system enables automation of the annual operational duration test. The battery charge level is shown as a percentage on the TFT touch display. A potential free changeover contact reports battery status to a higher level building services system on an as needed basis. Warning and alarm signals for deviations from boost charge, trickle charge voltage, discharge voltage and battery block temperature of each individual battery block are displayed and recorded on the TFT touch display as well as through a maximum of 72 battery block sensors. The wireless transfer of sensor data to a BDM module simplifies the installation of BBS battery block sensors because no additional data cable is required. The negative pole temperature reading via the sensor circuit means that there is no need for a direct temperature conducting connection between the BBS battery block sensor and the battery housing. Status displays that are clearly visible through a robust, trans luminescent BBS sensor enclosure, which has an integrated, mechanically protected colour LED, guarantee clear indications at a glance.

An automated configuration routine using soft addressing and menu navigation of the TFT touch display via user icons makes it very easy to manage the system sensor reports and provides a complete overview.

- Automatic recording of voltage and temperature figures during initial operation
- Wireless data transfer provides for connection to the battery block sensors without the need for an additional data cable
- Potential-free changeover contact for reporting operational status

Dimensions (LxHxD)	90x72x60 mm
Materials	Polycarbonate UL94V-0
Weight	0.06 kg
Assembly	DIN rail snap-on
Degree of protection	IP20
Protection class	II
Ambient temperature range	-5°C – +35°C

Order details

Model	Included with delivery	Order no.
BDM module	Battery data bus module for top-hat rail installation	40071361780

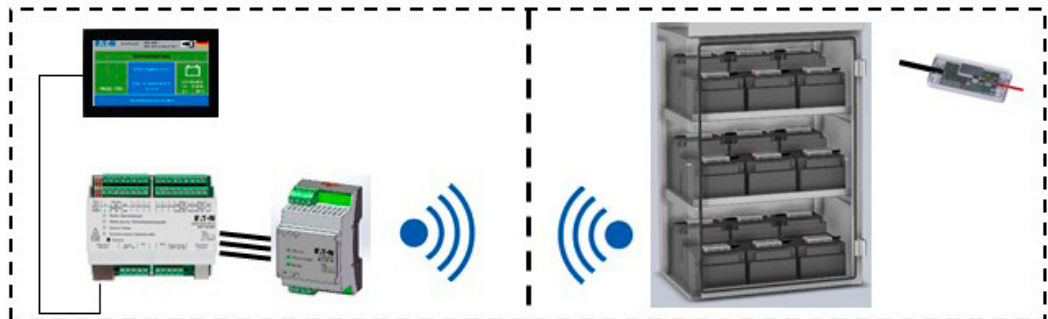

BBS



BBS battery block sensor

- Temperature readings are taken from the minus pole via the sensor cable, so no fixed connection is required between the battery block sensor and the battery housing
- Status displays that are clearly visible through a trans-luminescent sensor enclosure with an integrated LED
- Percentage display of the battery charge status in percent on the TFT touch display
- Warning and alarm signals for deviations from boost charge, trickle charge voltage and discharge voltage of each individual battery block on the TFT touch display as well as through the battery block sensor
- Warning and alarm signals for deviations from battery block temperature on the TFT touch display as well as through the battery block sensor

Dimensions (LxHxD)	90x53x17 mm
Materials	Polycarbonate UL94V-0
Weight	0.05 kg
Assembly	on the battery block cover
Degree of protection	IP20
Protection class	II
Ambient temperature range	-5°C – +35°C

Order details

Model	Included with delivery	Order no.
12V/M6 BBS sensor	Battery block sensor for 12V battery blocks with an M6 connection. 14Ah, 23.3Ah, 32Ah, 39.8Ah, 50.4Ah, 53.7Ah, 66.2Ah, 85.7Ah, 89.4Ah	40071362190
6V/M8 BBS sensor	Battery block sensor for 6V battery blocks with an M8 connection. 118Ah	40071362202

Configuring the central battery system

DualGuard-S – central battery system

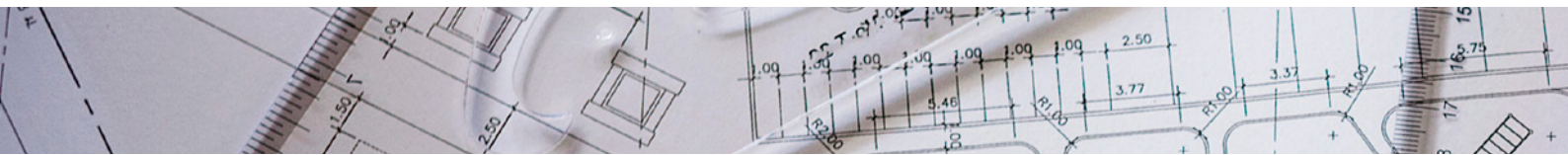

Configuring the central battery system

The DualGuard-S central battery system can be quickly and easily configured using predetermined data from the tables.

Recommended procedure:

Determine the required battery capacity.

The number of safety lights and emergency signs required is determined on the basis of the projected lighting design.

Example:

With respect to the safety lighting requirements for one assembly point (3 h rated operating period and 12 h recharging period), the following number of luminaires was determined.

Quantity	Model	Current consumption per light	Total
100	GuideLed 11011	0.011A	1.10A
250	GuideLed SL 13021.1	0.02A	5.00A
100	V-CG-SLI 350	0.043A	4.30A
Total:			10.40A

Depending on the rated operating period required (1, 3 and 8 h), the battery capacity (C10; 1.8V/cell; +20°C) relative to the maximum discharge current – determined via the battery power consumption of all consumers – can be determined using the battery discharge tables. Pursuant to EN 50171, batteries with a duration of at least 10 years at 20°C shall be used. In this example, with a required rated operating period of 3 h, a battery capacity of 39.80 Ah (C10: 1.8V/cell; +20°C) should be selected from the table. The maximum discharge current for 3 hours of discharge is 11.00A.

Determining the required number of additional charging modules

Pursuant to EN 50171, 80% of withdrawn capacity must be charged to the discharged batteries within 12 h. In determining the number of additional charging modules, the aging reserve factor of 25% need not be included.

Example:

Battery current uptake

= 11.00A for 3 h discharge

Required number of charging modules:

1 x 3.4A according to the charging module table



Determining the required battery capacity, including the aging allowance.

Since a lead battery that is properly operated generally has a capacity loss of up to 2.5% per year (25% over 10 years), pursuant to EN 50171 this loss of capacity must be allowed for in selecting a battery. The end of the service life has been reached when the battery's rated voltage under the rated load falls below 90%.

Example:

Battery current uptake

10.40A + 25%

Aging reserve = 13.00A

Battery U_{rated} = 216V

90% U_{rated} battery

(108 cells) = 194.4V = **1.8V per cell**

In this example, the battery capacity must be increased from 39.8 Ah to 50.40 Ah. The maximum discharge current for 3 hours of discharge is 13.60A.

Please note! – In determining the number of additional charging modules, the aging reserve factor of 25% need not be included.

Fuse protection of the mains circuit connection

The total connected load of the DualGuard-S system is needed to determine the fuse protection for the general power supply main distributor. This load consists of the sum of the mains connection loads of the individual lights and consumers (see connection values of charging modules CM.1 1.7 A and CM.1 3.4 A).

Example:

100 units GuideLed 11011 @ 8VA = 0.80kVA

250 units GuideLed SL 13021.1 @ 8VA = 2.00kVA

100 units V-CG-SLI 350

11.6VA = 1.16kVA

= 3.96kVA

Charge module CM 3.4A

Pzu 0.98kVA = 0.98kVA

Total connection load = 4.94kVA

Order details

DualGuard-S – central battery system



Order details

Model	Included with delivery	Order no.
DualGuard-S 28 central battery system	DualGuard-S/28 central battery system including TFT touch display, BCM.1 and PSU, 28 free module slots	40071362511
DualGuard-S 20 central battery system	DualGuard-S/20 central battery system including TFT touch display, BCM.1 and PSU, 20 free module slots	40071362510
DualGuard-S LAD100 central battery system	DualGuard-S LAD 100A central battery system, equipped with battery control module (BCM.1), TFT touch display HMI/ACU DG-S PCU transformer, with sufficient space for adding a maximum of 16 final circuits, or a maximum of 4 variable circuit boards. Please note! The charging modules are not part of the cabinet assembly.	40071362540
DualGuard-S 12C central battery system	DualGuard-S 12C central battery system including TFT touch display, BCM.1 and PSU, 12 free module slots	40071362520
DualGuard-S 20C6 central battery system	DualGuard-S 20C6 central battery system including TFT touch display, BCM.1 and PSU, 20 free module slots	40071362524
DualGuard-S 12C6 central battery system	DualGuard-S 12C6 central battery system including TFT touch display, BCM.1 and PSU, 12 free module slots	40071362523
DualGuard-S 12C4 central battery system	DualGuard-S 12C4 central battery system including TFT touch display, BCM.1 and PSU, 12 free module slots	40071362521
DualGuard-S 4C3 central battery system	DualGuard-S 4C3 central battery system including TFT touch display, BCM.1 and PSU, 4 free module slots	40071362525
DualGuard-S US 38 sub-station	DualGuard-US 38 model sub-station including TFT touch display, 38 free module slots	40071362513
DualGuard-S US 30 sub-station	DualGuard-US 30 model sub-station including TFT touch display, 30 free module slots	40071362512
DualGuard-S US 23 sub-station	DualGuard-US 23 model sub-station including TFT touch display, 23 free module slots	40071362532
DualGuard-S US 15 sub-station	DualGuard-US 15 model sub-station including TFT touch display, 15 free module slots	40071362531
DualGuard-S US 7 sub-station	DualGuard-US 7 model sub-station including TFT touch display, 7 free module slots	40071362530
DualGuard-S SOU2 sub-station	SOU2 model sub-station including 2 x SOU CG-S 2 x 4A	40071362519
DualGuard-S SOU1 sub-station	SOU1 model sub-station including 1 x SOU CG-S 2 x 4 A	40071362518
E30 junction box ESF-RVS30-1	for SOU small distribution boards with 2 built-in Neozed fuses	40036071032
DualGuard-S ESF30-30-P sub-station	DualGuard-S ESF30-30-P cabinet, equipped with TFT touch display, PSU, with space for adding a maximum of 58 final circuits, but a maximum of 30 variable circuit modules	40071362517
DualGuard-S ESF30 15-P sub-station	DualGuard-S ESF30 15-P cabinet, equipped with TFT touch display, PSU, with space for adding a maximum of 40 final circuits, but a maximum of 15 variable circuit modules	40071362516
ESF30 SOU5 sub-station	ESF30 SOU5 small distribution board, fitted with 5 circuit modules SOU CG-S 2 x 4 A	40071362538
ESF30 SOU3 sub-station	ESF30 SOU3 small distribution board, fitted with 3 circuit modules SOU CG-S 2 x 4 A	40071362537
ESF30 SOU2 sub-station	ESF30 SOU2 small distribution board, fitted with 2 circuit modules SOU CG-S 2 x 4 A	40071362536
ESF30 SOU1 sub-station	ESF30 SOU1 small distribution board, fitted with 1 circuit module SOU CG-S 2 x 4 A	40071362535



Order details

Model	Included with delivery	Order no.
ESF-RVS30	ESF-RVS30 distribution board for ESF-E30 with 4 built-in D02 Neozed fuses	40071347920
Reductions	M32 to M20 reductions including M20 cable screw fitting for E30 junction box.	40071071033
Base for DualGuard-S 12C4	600 mm x 400 mm x 100 mm base	40071362280
	600 mm x 400 mm x 200 mm base	40071362281
Base for DualGuard-S 28, 20, LAD 100, US 38, US 30 and DualGuard-S 12C	800 mm x 400 mm x 100 mm base	40071362282
	800 mm x 400 mm x 200 mm base	40071362283
Base for DualGuard-S 20C6 und 12C6	800 mm x 600 mm x 100 mm base	40071362284
	800 mm x 600 mm x 200 mm base	40071362285
Grommet Set	for DualGuard-S 12C4	40071362404
	for DualGuard-S 28/20 DG-S US 38/30	40071362405
	for DualGuard-S LAD	40071362406
	for DualGuard-S 20C6	40071362407
	for DualGuard-S 12C6	40071362408
	for DualGuard-S 12C	40071362409
	for DualGuard-S 4C3	40071362410
	for DualGuard-S US23	40071362411
	for DualGuard-S US15	40071362412
	for DualGuard-S US7	40071362413
	for Battery Cab.	40071362414
The DualGuard-S third party certificate includes a higher IP rating, and is no longer valid for use with lower rated roof panels.		
Roof plate with foam rubber flange plates IP 2X	for DualGuard-S 28, 20, US 38 and US 28	40071362441
	for DualGuard-S LAD 100	40071362444
	for DualGuard-S 20C6	40071362445
	for DualGuard-S 12C6	40071362442
	for DualGuard-S 12C	40071362443
	for DualGuard-S 12C4	40071362440
Roof plate with rubber clamp profile IP 2X	for DualGuard-S 28, 20, US 38 and US 28	40071362451
	for DualGuard-S LAD 100	40071362454
	for DualGuard-S 20C6	40071362455
	for DualGuard-S 12C6	40071362452
	for DualGuard-S 12C	40071362453
Optional IP 31 retrofitting kit	for DualGuard-S 12C4	40071362450
	for DualGuard-S 4C3	40071362298
	for DualGuard-S 12C	40071362293
	for DualGuard-S 12C4	40071362290
Left-hand hinge position	for DualGuard-S 12C6	40071362292
	for DualGuard-S 20C6	40071362297
	for DualGuard-S 28, 20, US 38 and 30	40071362291
	for DualGuard-S LAD 100	40071362296
	for DualGuard-S battery cabinets	40071362294
	for DualGuard-S 12C	40071362303
	for DualGuard-S 12C4	40071362300
Left-hand hinge position	for DualGuard-S 12C6	40071362302
	for DualGuard-S 20C6	40071362306
	for DualGuard-S 28, 20, LAD 100, US 38, 30	40071362301

Technical data

DualGuard-S – central battery system

DualGuard-S compact cabinets

Model	DualGuard-S 28	DualGuard-S 20	DualGuard-S LAD 100
Control section: ACU DG-S & HMI	1	1	1
PSU	1	1	1
BCM.1	1	1	1
SKU.1 CG-S circuit module	0-28	0-20	0-4
CM.1 1.7A charging module	0-1	0-1	0-1
CM.1 3.4A charging module	0-6	0-6	0-8
Cabinet design, electric:			
Rated voltage	400/230V	400/230V	400/230V
Rated frequency	50/60 Hz	50/60 Hz	50/60 Hz
Cable placement and grounding system in mains mode / battery mode	TN-C-S/IT	TN-C-S/IT	TN-C-S/IT
Max. ambient temperature ^{*1}	-5°C to +35°C	-5°C to +35°C	-5°C to +35°C
Protection class	1	1	1
Degree of protection	IP21	IP21	IP21
Max. rated current (mains) [\sum L1, L2, L3] [A]	80	80	100
Max. rated output (mains) [KW]	18.4	18.4	23
Max. rated current (battery) [A]	80	80	100
Max. rated output (battery) [KW]	17.3	17.3	21.6
Three-phase split	yes	yes	yes
Connection diameter for mains and battery feed	50 mm ²	50 mm ²	50 mm ²
Outlet distributor	0- 6 outlets	0- 6 outlets	0- 15 outlets DC and AC 1-phase, 0-5 outputs AC 3-phase
Terminal capacity	16 mm ²	16 mm ²	16 mm ²
Max. connection diameter final circuit	4 mm ²	4 mm ²	4 mm ²
Max. number of final circuit connections	88	88	16
Cabinet design, mechanical:			
Dimensions H x W x D (mm)	2070 x 800 x 405	2070 x 800 x 405	2040 x 800 x 405
Material/design	Sheet steel/free-standing cabinet	Sheet steel/free-standing cabinet	Sheet steel/free-standing cabinet
Hinge position	Right	Right	Right
Outer finish	Powder coating	Powder coating	Powder coating
Colour	RAL 7035	RAL 7035	RAL 7035
Colour touch in-door	Yes	Yes	Yes
Partial glazed door	–	–	–
Lock mechanism	3 mm double ward key	3 mm double ward key	3 mm double ward key
cable inlets on top	Yes	Yes	Yes
Cable inlets on bottom	Yes	Yes	Yes
Base (optional)	100/200	100/200	100/200
Weight (w/o battery)	approx. 180 kg	approx. 170 kg	approx. 170 kg
Battery capacity, integrated into:			
Battery cabinet (W x H x D: 2050 x 800 x 400 mm)	23.3-245 Ah	23.3-245 Ah	23.3-308 Ah
Compact cabinet	–	–	–
Battery rack	23.3-245 Ah	23.3-245 Ah	23.3-308 Ah

*1 Optimal ambient temperature battery +20°C

DualGuard-S compact cabinets

DualGuard-S20C6	DualGuard-S12C6	DualGuard-S 12C	DualGuard-S12C4	DualGuard-S4C3
1	1	1	1	1
1	1	1	1	1
1	1	1	1	1
0-20	0-12	0-12	0-12	0-5
0-1	0-1	0-1	0-2	1
0-2	0-2	0-1	–	–
400/230V	230V	230V	230V	230V
50/60 Hz	50/60 Hz	50/60 Hz	50/60 Hz	50/60 Hz
TN-C-S/IT	TN-C-S/IT	TN-C-S/IT	TN-C-S/IT	TN-C-S/IT
-5°C to +35°C	-5°C to +35°C	-5°C to +35°C	-5°C to +35°C	-5°C to +35°C
1	1	1	1	1
IP21	IP21	IP21	IP21	IP21
50	50	35	25	12
14.5	14.5	13.8	5.8	3.5
50	50	35	25	12
13.6	13.6	7.6	5.4	2.6
–	–	–	–	–
35 mm ²	16 mm ²	16 mm ²	16 mm ²	16 mm ²
2 outlets	1 outlet	1 outlet	1 outlet	–
35 mm ²	35 mm ²	35 mm ²	16 mm ²	–
4 mm ²	4 mm ²	4 mm ²	4 mm ²	4 mm ²
68	48	48	48	20
2070 x 800 x 600	2040 x 800 x 605	2040 x 800 x 405	1800 x 600 x 405	1000 x 600 x 300
Compact cabinet	Compact cabinet	Compact cabinet	Compact cabinet	Compact cabinet
Right	Right	Right	Right	Right
Powder coating	Powder coating	Powder coating	Powder coating	Powder coating
RAL 7035	RAL 7035	RAL 7035	RAL 7035	RAL 7035
–	–	–	–	–
Yes	Yes	Yes	Yes	Yes
3mm double ward key	3mm double ward key	3mm double ward key	3mm double ward key	3mm double ward key
Yes	Yes	Yes	Yes	Yes
No	No	No	No	No
100/200	100/200	100/200	100/200	–
approx. 205 kg	approx. 206 kg	approx. 155 kg	approx. 115 kg	approx. 50 kg
–	–	–	–	–
5.5-89.4 Ah	5.5-89.4 Ah	23.3-53.7 Ah	5.5-23.3 Ah	5.5-14 Ah
–	–	–	–	–

Technical data

DualGuard-S – central battery system

DualGuard-S US sub-stations

Model	DualGuard-S US 38	DualGuard-S US 30	DualGuard-S US 23	DualGuard-S US 15	DualGuard-S US 7
Modules:					
Control section: ACU DG-S & HMI	1	1	1	1	1
PSU	1	1	1	1	1
SKU.1 CG-S circuit module	0-38	0-30	0-23*1	0-15	0-7
Cabinet design, electric:					
Rated voltage	400/230V	400/230V	230V	230V	230V
Rated frequency	50/60 Hz	50/60 Hz	50/60 Hz	50/60 Hz	50/60 Hz
Cable placement and grounding system in mains/battery mode	TN-C-S/IT	TN-C-S/IT	TN-C-S/IT	TN-C-S/IT	TN-C-S/IT
Max. ambient temperature range	-5°C to +35°C	-5°C to +35°C	-5°C to +35°C	-5°C to +35°C	-5°C to +35°C
Protection class	1	1	1	1	1
Degree of protection	IP21	IP21	IP54	IP54	IP54
Max. rated current (mains) [Σ L1, L2, L3] [A]	80	80	50	50	25
Max. rated output (mains) [KW]	18.4	18.4	11.5	11.5	6.9
Max. rated current (battery) [A]	80	80	50	50	25
Max. rated output (battery) [KW]	17.3	17.3	10.8	10.8	6.5
Three-phase split	Yes	Yes	No	No	No
Connection diameter for mains and battery feed	35 mm ²	35 mm ²	35 mm ²	16 mm ²	16 mm ²
Terminal capacity	–	–	–	–	–
Max. connection diameter of final circuit	4 mm ²	4 mm ²	4 mm ²	4 mm ²	4 mm ²
Max. number of final circuit connections	88	88	52	32	28
Cabinet design, mechanical:					
Dimensions H x W x D (mm)	2070 x 800 x 405	2070 x 800 x 405	1200 x 600 x 300	800 x 600 x 300	600 x 400 x 300
Material/design	Sheet steel/ free-standing cabinet	Sheet steel/ free-standing cabinet	Sheet steel/wall cabinet	Sheet steel/wall cabinet	Sheet steel/wall cabinet
Hinge position	Right	Right	Right	Right	Right
Outer finish	Powder coating	Powder coating	Powder coating	Powder coating	Powder coating
Colour	RAL 7035	RAL 7035	RAL 7035	RAL 7035	RAL 7035
Partial glazed door	Yes	Yes	No	No	No
Lock mechanism	3 mm double ward key	3 mm double ward key	3 mm double ward key	3 mm double ward key	3 mm double ward key
Cable inlets on top	Yes	Yes	Yes	Yes	Yes
Cable inlets on bottom	Yes	Yes	No	No	No
Base (optional)	100/200	100/200	–	–	–
Weight (w/o battery)	approx. 170 kg	approx. 165 kg	approx. 110 kg	approx. 75 kg	approx. 42 kg

*1 A maximum of 12 SKU.1 CG-S 4 x 1.5 A may be installed.

DualGuard-S SOU sub-stations

Model	SOU2	SOU1
SKU.1 CG-S *1 circuit module	including 2 x SOU CG-S 2 x 4A	including 1 x SOU CG-S 2 x 4A
Cabinet design, electric:		
Rated voltage	230V	230V
Rated frequency	50/60 Hz	50/60 Hz
Cable placement and grounding system in mains/ battery mode	TN-C-S/IT	TN-C-S/IT
Max. ambient temperature range	-5°C to +35°C	-5°C to +35°C
Protection class	2	2
Degree of protection	IP65	IP65
Max. rated current (mains) $\sum L1, L2, L3$ [A]	16	8
Max. rated output (mains) [KW]	3.6	1.8
Max. rated current (battery) [A]	16	8
Max. rated output (battery) [KW]	3.4	1.7
Three-phase split	No	No
Connection diameter for mains and battery feed	10 mm ²	10 mm ²
Max. connection diameter of final circuit	4 mm ²	4 mm ²
Max. number of final circuit connections	4	2
Cabinet design, mechanical:		
Dimensions H x W x D (mm)	583 x 295 x 129	458 x 295 x 129
Material/design	Plastic small distribution board	Plastic small distribution board
Hinge position	Right	Right
Colour	RAL 7035	RAL 7035
Partial glazed door	Yes	Yes
Lock mechanism	On request	On request
Cable inlets on top	Yes	Yes
Weight (w/o battery)	approx. 8.8 kg	approx. 7.5 kg

Technical data

DualGuard-S – central battery system

DualGuard-S ESF sub-stations

Model	DualGuard-S ESF30 15P	DualGuard-S ESF30 30P
Modules:		
Control section: ACU DG-S & HMI	1	1
PSU	1	1
SKU.1 CG-S 1 x 6A circuit module	0-15	0-30
SKU.1 CG-S 2 x 3A circuit module	0-15	0-30
SKU.1 CG-S 4 x 1.5A circuit module	0-15	0-30
DLS/TLS interface module	1	2
Cabinet design, electric:		
Rated voltage	230V	400/230V
Rated frequency	50/60 Hz	50/60 Hz
Ventilation, decibel level (dB)	55	55
Cable placement and grounding system in mains/battery mode	TN-C-S/IT	TN-C-S/IT
Max. ambient temperature range	-5°C to +35°C	-5°C to +30°C
Protection class	I	I
Degree of protection	IP42	IP42
Max. total rated current [A] relative to ambient temperature		
+25°C	33	48
+30°C	33	48
+35°C	33	48
Max. total rated output [A] relative to ambient temperature		
+25°C	7	10.3
+30°C	7	10.3
+35°C	7	10.3
Three-phase split	No	Yes
Connection diameter for mains and battery feed	35 mm ²	35 mm ²
Max. connection diameter of final circuit	4 mm ²	4 mm ²
Max. number of final circuit connections	40	58
Cabinet design, mechanical:		
Dimensions H x W x D (mm)	1278x918x496	2278x918x604
Material/design	Coated gypsum fiber-board/wall cabinet	Coated gypsum fiber-board/free-standing cabinet
Hinge position	Right	Right
Colour	RAL 7035	RAL 7035
Cable entry	From above	From above
Base (optional)	–	– only with base
Weight	210 kg	approx. 330 kg
Licenses/certifications		
ABZ housing including components Z-86.3 ...	requested	requested
ABZ empty housing Z-86.1 ...	Yes	Yes
Summary report for functional integrity fire test MPA NRW	Yes	Yes
VDE certificate	–	–
Specialized company declaration	Yes	Yes

DualGuard-S ESF sub-stations SOU

Model	ESF30 SOU5	ESF30 SOU3	ESF30 SOU2	ESF30 SOU1
Modules:				
SOU CG-S 2 x 4 A circuit switching module	5	3	2	1
DLS/TLS interface module	2	1	1	–
Cabinet design, electric:				
Rated voltage	230V	230V	230V	230V
Rated frequency	50 or 60 Hz	50 or 60 Hz	50 or 60 Hz	50 or 60 Hz
Ventilation, decibel level (dB)	–	–	–	–
Cable placement and grounding system in mains/battery mode	TN-C-S/IT	TN-C-S/IT	TN-C-S/IT	TN-C-S/IT
Max. ambient temperature range	-5°C to +35°C	-5°C to +35°C	-5°C to +35°C	-5°C to +35°C
Protection class	I	I	I	I
Degree of protection	IP65	IP65	IP65	IP65
Maximum installed heat dissipation performance [W]				
Max. total rated current [A] relative to ambient temperature				
+25°C	33	20	15	8
+30°C	28	17	12	6
+35°C	16	10	9	5
Max. total rated output [A] relative to ambient temperature				
+25°C	7.1	4.3	3.2	1.7
+30°C	6.0	3.6	2.5	1.2
+35°C	3.4	2.1	1.3	1.0
Three-phase split	No	No	No	No
Connection diameter for mains and battery feed	10 mm ²	10 mm ²	10 mm ²	10 mm ²
Max. connection diameter final circuit	4 mm ²	4 mm ²	4 mm ²	4 mm ²
Max. number of final circuit connections	10	6	4	2
Cabinet design, mechanical:				
Dimensions H x W x D (mm)	1135 x 396 x 230	835 x 396 x 230	685 x 396 x 230	535 x 396 x 230
Material/design	Coated gypsum fiberboard/wall cabinet	Coated gypsum fiberboard/wall cabinet	Coated gypsum fiberboard/wall cabinet	
Hinge position	Left	Left	Left	Left
Colour	RAL 7035	RAL 7035	RAL 7035	RAL 7035
Cable entry	From above	From above	From above	From above
Weight (w/o battery)	approx. 81 kg	approx. 61 kg	approx. 51 kg	approx. 34 kg
Licenses/certifications				
ABZ housing including components Z-86.3 ...	–	–	–	–
ABZ empty housing Z-86.1 ...	–	–	–	–
Summary report for functional integrity fire test MPA NRW	Yes	Yes	Yes	Yes
VDE certificate	Yes	Yes	Yes	Yes
Specialized company declaration	–	–	–	–

Determination of battery capacity

DualGuard-S – central battery system

Table 1

Determining the required battery capacity from maintenance-free AGiV block batteries as per EN 50171 (larger battery capacities on request).

C10 battery capacity at 1.8V/cell and +20°C	Ah	5.5	8.5	14.0	23.3	32.0	39.8	50.4	53.7	66.2	85.7	89.4	106.0	118.0	143.1	155.6	178.8	195.4	245.0	268.2	308.0	357.6	
													1 x 39.8			1 x 89.4							
													1 x 66.2			1 x 53.7							
																1 x 89.4							
																1 x 66.2							
																	2 x 89.4						
																	1 x 89.4						
																	1 x 66.2						
																	1 x 39.8						
																	2 x 89.4						
																	1 x 66.2						
																	3 x 89.4						
																	3 x 89.4						
																	1 x 39.8						
																	4 x 89.4						
Max. discharge current [A] at rated operating period [h], 1.8V per cell and +20°C	1.0	3.2	4.5	9.3	15.4	20.2	24.1	30.7	37.9	49.2	52.6	63.8	73.3	85.1	101.7	113.0	127.6	137.1	176.8	191.4	215.5	255.2	
	1.5	2.5	3.4	6.9	11.9	15.0	19.0	22.7	27.6	34.5	38.3	46.1	53.5	60.0	73.7	80.6	92.2	99.6	126.7	138.3	157.3	194.7	
	2.0	2.1	2.9	5.7	9.2	12.3	14.6	18.5	21.5	26.3	31.0	36.0	40.9	46.9	57.5	62.3	72.0	76.9	98.3	108.0	122.6	144.0	
	3.0	1.5	2.1	4.1	6.9	9.1	11.0	13.6	15.8	18.2	23.1	26.5	29.2	33.3	42.3	44.7	53.0	55.7	71.2	79.5	90.5	106.0	
	8.0	0.7	1.0	1.7	2.8	3.7	4.8	5.9	6.6	7.9	10.3	11.0	12.7	14.2	17.6	18.9	22.0	23.7	29.9	33.0	37.8	44.0	

Special note: The aging allowance of 25% for the batteries is not included in the discharge current figures.

Table 2

Number of 1.7A and 3.4A charging modules given a recharging time as per DIN EN 50171 of:

C10 battery capacity at 1.8V/cell and +20°C	h	A	5.5	8.5	14.0	23.3	32.0	39.8	50.4	53.7	66.2	85.7	89.4	106.0	118.0	143.1	155.6	178.8	195.4	245.0	268.2	308.0	357.6
12 hours/80%	1.0	1.7	1	1	1	1	1	0	0	0	1	1	1	0	0	1	0	0	1	1	1	1	0
		3.4	0	0	0	0	0	1	1	1	1	1	1	1	2	2	2	3	3	3	4	4	5
	1.5	1.7	1	1	1	1	0	0	0	0	1	1	0	0	1	0	0	1	1	1	0	0	1
		3.4	0	0	0	0	1	1	1	1	1	1	2	2	2	3	3	3	3	4	5	6	6
	2.0	1.7	1	1	1	1	0	0	0	0	1	1	0	0	1	0	0	1	0	0	1	0	0
		3.4	0	0	0	0	1	1	1	1	1	1	2	2	2	3	3	3	4	5	5	6	7
	3.0	1.7	1	1	1	1	0	0	0	1	1	1	0	1	1	0	1	0	0	0	0	1	1
		3.4	0	0	0	0	1	1	1	1	1	1	2	2	2	3	3	4	4	5	6	6	7
	8.0	1.7	1	1	1	0	0	0	1	1	1	0	0	1	0	1	0	1	1	0	1	1	1
		3.4	0	0	0	1	1	1	1	1	1	2	2	2	3	3	4	4	4	6	6	7	8

Table 3

Number of battery cabinets; battery weight

C10 battery capacity at 1.8V/cell and +20°C	5.5	8.5	14.0	23.3	32.0	39.8	50.4	53.7	66.2	85.7	89.4	106.0	118.0	143.1	155.6	178.8	195.4	245.0	268.2	308.0	357.6
Number of battery cabinets (weight/cabinet approx. 150 kg)	1	1	1	1	1	1	1	1	1	1	1	2	2	2	2	2	3	3	3	4	4
Total weight per battery set approx. kg	45	65	100	180	243	252	351	405	499	527	594	612	900	1000	1093	1296	1354	1687	1782	1782	2376

Table 4

Determination of air supply and ventilation in electrical operating rooms according to DIN EN 50272-2 (calculated for boost charge):

216V battery	5.5	8.5	14.0	23.3	32.0	39.8	50.4	53.7	66.2	85.7	89.4	106.0	118.0	143.1	155.6	178.8	195.4	245.0	268.2	308.0	357.6
Air volume flow required to ventilate the installation space [m³/h]	0.24	0.37	0.60	1.01	1.38	1.72	2.18	2.32	2.86	3.70	3.86	4.58	5.10	6.18	6.72	7.72	8.44	10.58	11.59	13.31	15.45
Ventilation cross-section of the inlet and outlet openings of the installation space [cm²]	6.65	10.28	16.93	28.18	38.71	48.14	60.96	64.96	80.08	103.66	108.14	128.22	142.73	173.09	188.21	216.28	236.36	296.35	324.41	372.56	432.55

Table 5

Determination of air supply and ventilation in electrical operating rooms according to DIN EN 50272-2 (calculated for boost charge*):

216V battery	5.5	8.5	14.0	23.3	32.0	39.8	50.4	53.7	66.2	85.7	89.4	106.0	118.0	143.1	155.6	178.8	195.4	245.0	268.2	308.0	357.6
Air volume flow required to ventilate the installation space [m³/h]	0.03	0.05	0.08	0.13	0.17	0.21	0.27	0.29	0.36	0.46	0.48	0.57	0.64	0.77	0.84	0.97	1.06	1.32	1.45	1.66	1.93
Ventilation cross-section of the inlet and outlet openings of the installation space [cm²]	0.83	1.29	2.12	3.52	4.84	6.02	7.62	8.12	10.01	12.96	13.52	16.03	17.84	21.64	23.53	27.03	29.54	37.04	40.55	46.57	54.07

* If a boost charge is not frequently used (for example, once a month), the air flow rate for ventilation can be calculated based on the trickle charge current.

Examples of the DualGuard-S – cabinet configurations

DualGuard-S – central battery system



Adaptive evacuation

DualGuard-S – central battery system



System-related measures to guarantee self-rescue in the event of evacuation take top priority in changing risk situations. In combination with GuideLed DXC emergency signs, the AE-CU technology makes it possible to respond in a proactive manner to changing hazard situations such as fire, attacks, or natural disasters. The shortest route out of a building is not always the safest route.

During a hazardous situation, the AE-CU system reliably controls up to 240 adaptive emergency signs via an open circuit- and short circuit-tolerant loop bus.

This approach allows every adaptive emergency sign to be associated with hazard scenarios in a freely programmable manner via the AE-CU.

The control section, which has a non-volatile program memory and a large touch display, automatically monitors and controls all components of the AE-CU system as well as the function of the connected adaptive luminaires. Any faults that occur are shown on the display, reported via signaling contacts, and stored in an inspection log.

An integrated search function automatically detects all GuideLed DXC emergency signs connected during the installation. It is possible to connect a central visualisation system via an interface.

The solution for simple structured applications

Control of GuideLed DX luminaires via potential-free contacts:

Potential-free contacts of fire detectors, video surveillance systems or key switches to indicate areas as "locked, blocked, or unsafe." Examples include areas to which access is prohibited for a certain period of time due to construction activities or to block elevator access in the event of a fire (special pictogram). Only one control line leads to the emergency sign.

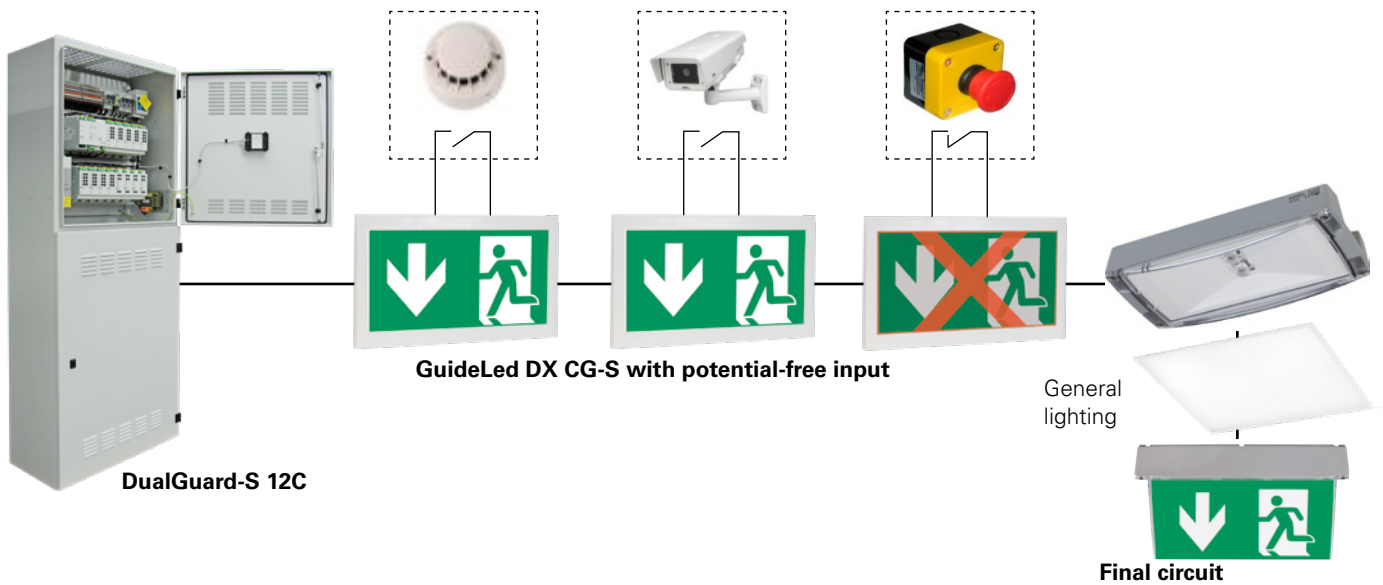

The solution for simple structured and complex applications

Control of GuideLed DXC luminaires via the loop bus:

Loop Bus and power supply in separate cable routing. This enables the mixed operation of DXC luminaires, static luminaires and external luminaires in one circuit.

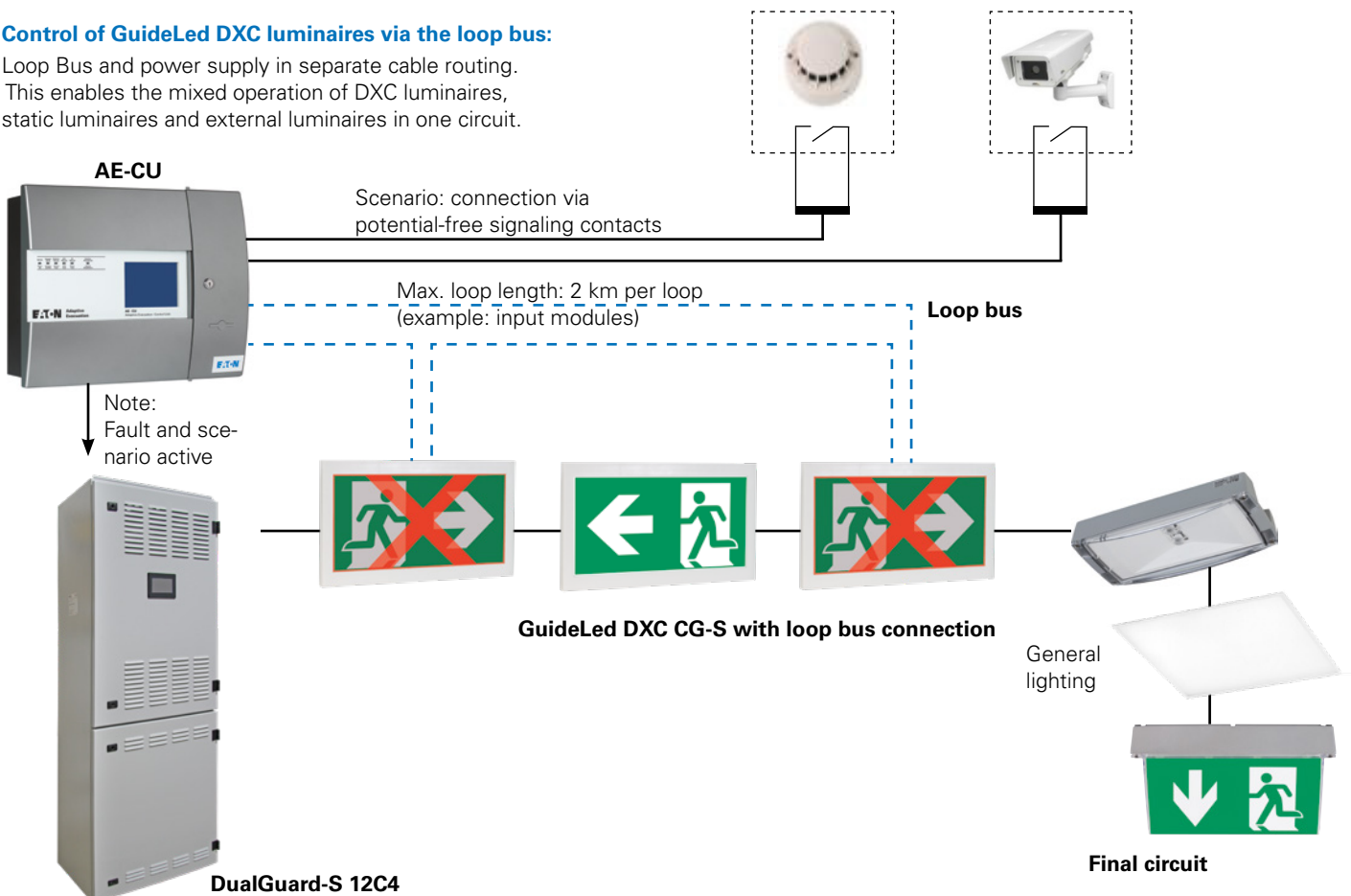

Notes

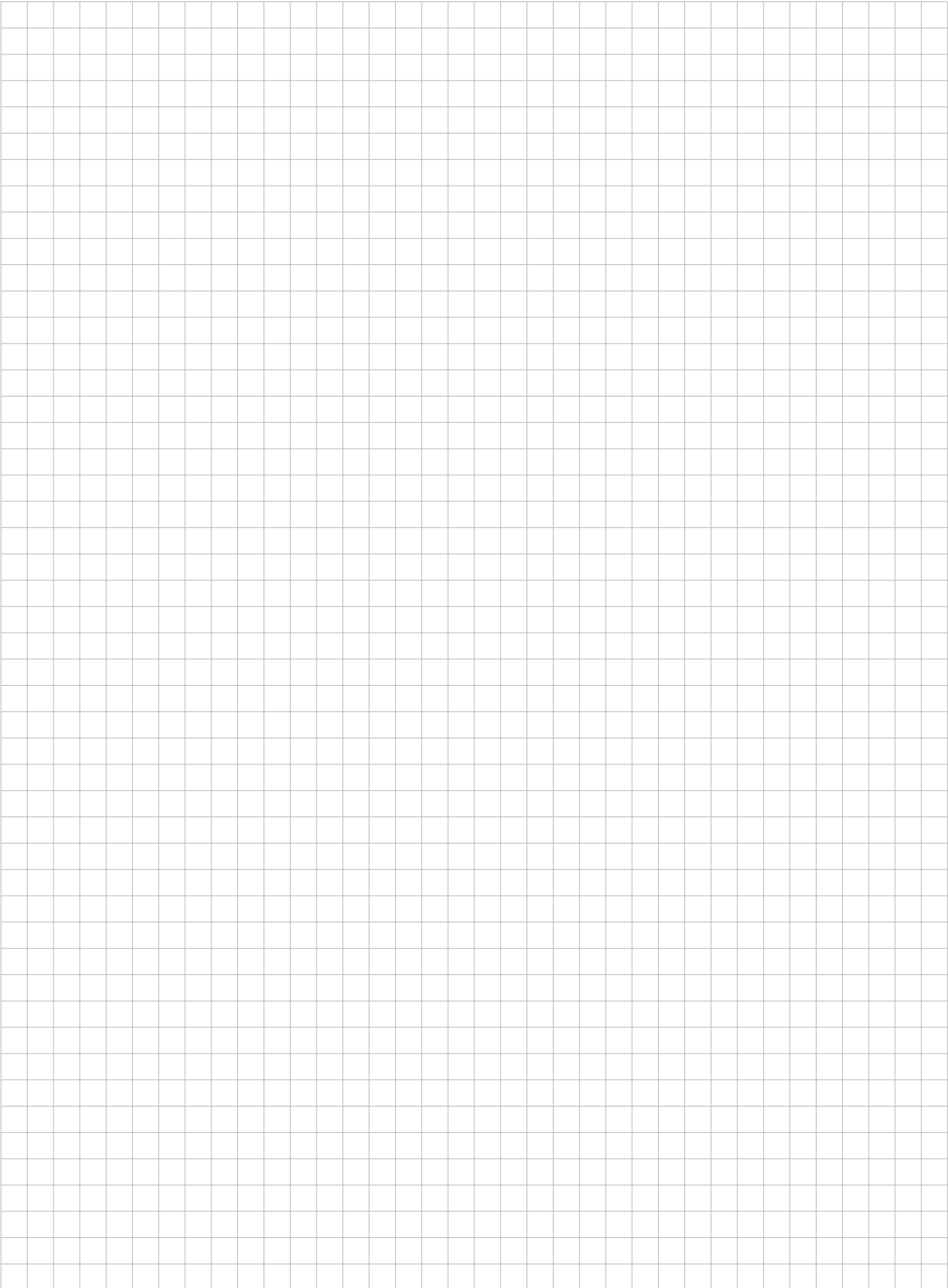

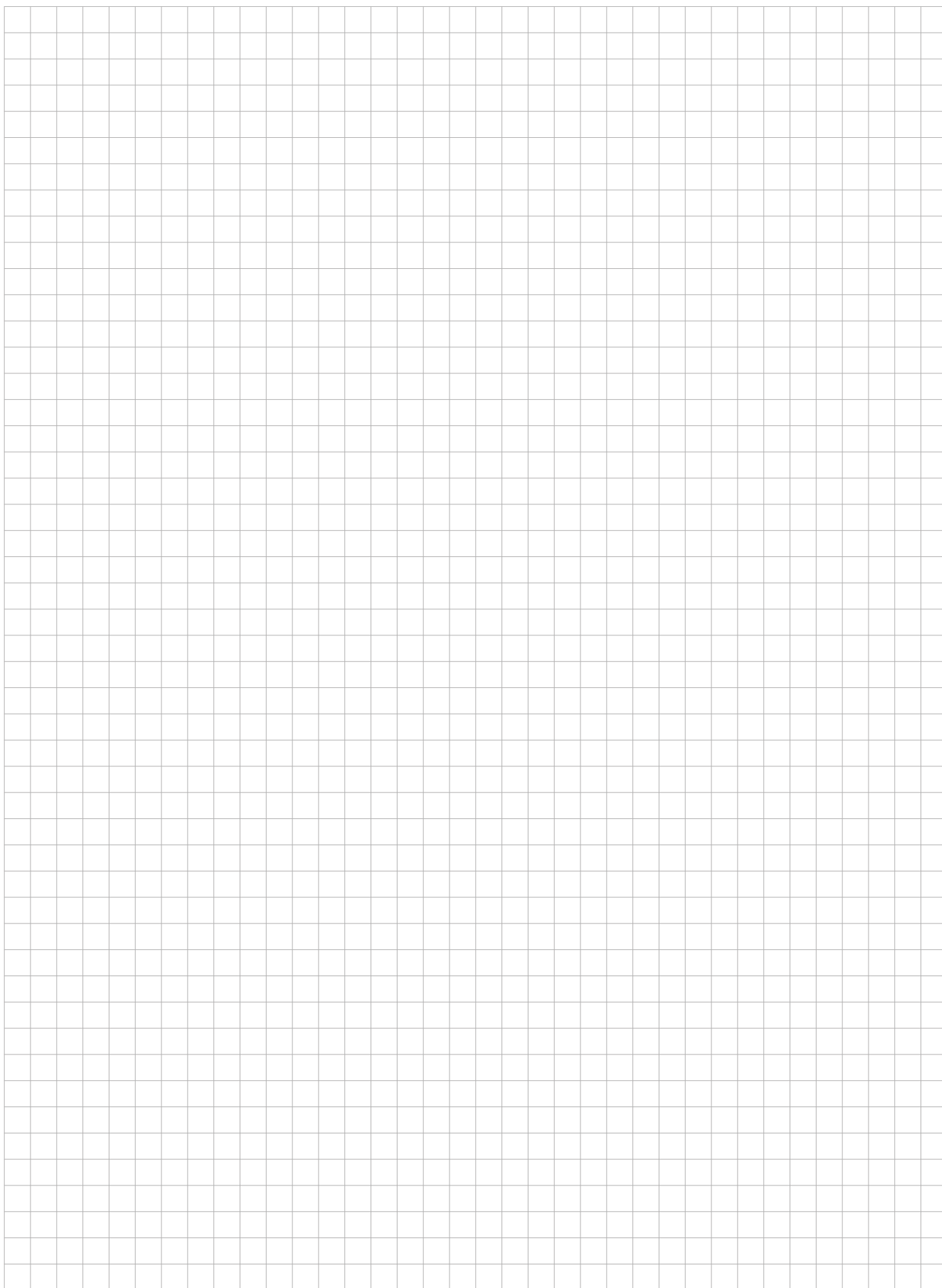

Eaton
EMEA Headquarters
Route de la Longeraie 7
1110 Morges, Switzerland
www.eaton.eu

CEAG Notlichtsysteme GmbH
Senator-Schwartz-Ring 26
59494 Soest, Germany
Tel.: +49 (0) 2921 69-870
Fax: +49 (0) 2921 69-617
Email: info-n@ceag.de
Website: www.ceag.de

© 2020 Eaton
All Rights Reserved
Printed in Germany
June 2020 – UK



The products, information and prices contained in this document are subject to change. We also reserve the right to correct any errors or omissions. Only order confirmations and technical documentation received from Eaton are binding. Images and illustrations are indicative only and do not guarantee any particular design or functionality. Their use in whatever form is subject to prior approval by Eaton. The same applies to Trademarks (especially to Eaton, Moeller, and Cutler-Hammer). The Terms and Conditions of Eaton apply, as referenced on Eaton internet pages and Eaton order confirmations.

Eaton is a registered trademark.

All other trademarks are the property of their respective owners.



Eaton.com/recycling