

PROLUMIA®

PRODISC III + PRODISC III MINI



OPERATING INSTRUCTION

GEBRUIKSAANWIJZING
MANUEL D'UTILISATION
INSTALAČNÍ NÁVOD
GEBRAUCHSANLEITUNG

White Black

40009370	40009375	Prodisc III
40009371	40009376	Prodisc III + Microwave sensor
40009380	40009385	Prodisc III Mini
40009381	40009386	Prodisc III Mini + Microwave sensor

CE □ IP44   LED

ATTENTIE

Lees de volgende instructies zorgvuldig door om ervoor te zorgen dat de montagewerkzaamheden op de juiste manier worden uitgevoerd. Bewaar deze instructies goed voor eventueel toekomstig gebruik.

OPGELET

1. Het product dient te worden geïnstalleerd door gekwalificeerde personen. De installatie dient, voorafgaand aan de montage, spanningsloos te worden gemaakt.
2. De installatiedraad moet minimaal 2 x 1,0 mm² zijn en worden aangesloten in overeenstemming met de laatste elektriciteitsvoorschriften van IEE of volgens de nationale eisen.
3. Raak de LED's niet aan tijdens installatie of onderhoud.
4. Dit product bevat een lichtbron van energie-efficiëntieklasse E.

TECHNISCHE DATA

Voedingsspanning: AC 220-240V 50/60Hz

Lichtbron: LED SMD2835

Bedrijfstemperatuur: -25°C – +50°C (Sensor versie: -25°C – +40°C)

Elektrische veiligheidsklasse: Klasse II

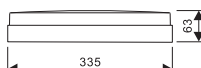

Prodisc III



Prodisc III Mini

TECHNISCHE INFORMATIE

Artikelnr.	Spanning	LED type	Vermogen	Lichtstroom	MW sensor
------------	----------	----------	----------	-------------	-----------

Witte uitvoering

40009370	220-240V 50/60Hz	SMD2835	15W	850Lm / 1190Lm / 1700Lm	-
40009371	220-240V 50/60Hz	SMD2835	16,5W	850Lm / 1190Lm / 1700Lm	Ja
40009380	220-240V 50/60Hz	SMD2835	9W	485Lm / 970Lm	-
40009381	220-240V 50/60Hz	SMD2835	10,5W	485Lm / 970Lm	Ja

Zwarte uitvoering

40009375	220-240V 50/60Hz	SMD2835	15W	750Lm / 1125Lm / 1500Lm	-
40009376	220-240V 50/60Hz	SMD2835	16,5W	750Lm / 1125Lm / 1500Lm	Ja
40009385	220-240V 50/60Hz	SMD2835	9W	440Lm / 880Lm	-
40009386	220-240V 50/60Hz	SMD2835	10,5W	440Lm / 880Lm	Ja

MICROWAVE SENSOR - BESCHRIJVING

Detectiebereik max. (D x H): 12m x 6m

Detectiegevoeligheid: 50% of 100%, instelbaar

Brandduur: 5sec - 10min, instelbaar

Daglicht aan: 5 - 50Lux, instelbaar of uitgeschakeld

Daglicht uit: 25 - 150Lux, instelbaar of uitgeschakeld

Stand-by periode (laag lichtniveau): 0 sec - +∞, instelbaar

Stand-by dim niveau: 10% of 25%, instelbaar

Montagehoogte plafond: 6m max.

Bewegingsdetectie (drempel): 0,3 ~ 3m/s

Detectiehoek: 150° (wandmontage),

360° (plafondmontage)

Detectiebereik (m) wandmontage
Voorgestelde montagehoogte: 2m

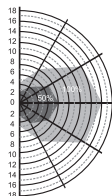

Bewegingssnelheid: 0,3m/s

Detectiebereik (m) plafondmontage
Voorgestelde montagehoogte: 3m

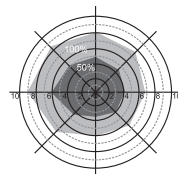

Bewegingssnelheid: 0,3m/s

MICROWAVE SENSOR - INSTELLING PARAMETERS

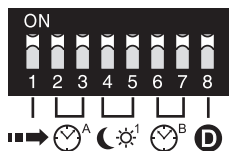

➡ Detectiebereik

Dit bepaalt het effectieve bereik van de bewegingsmelder en wordt met de micro-schakelaars op de driver ingesteld. Wees er van bewust dat het verminderen van de gevoeligheid ook het detectiebereik zal verkleinen.

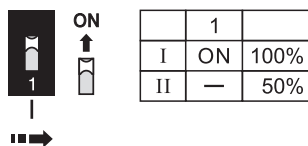

🕒^A Nalooptijd

Dit bepaalt de tijd dat het armatuur op 100% niveau blijft branden. Dit kan worden ingesteld met micro-schakelaars op de driver. Tijdens het installeren van het armatuur is de looptest-instelling (5s) handig om de juiste werking en het bereik vast te stellen.

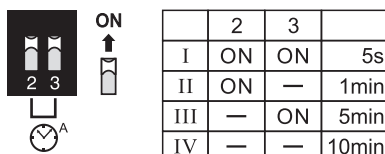

☀️¹ Daglicht

Met deze instelling kan worden bepaald bij welk daglichtniveau het armatuur al/dan niet zal worden ingeschakeld bij bewegingsdetectie. De fotocel functionaliteit kan ook worden uitgeschakeld.

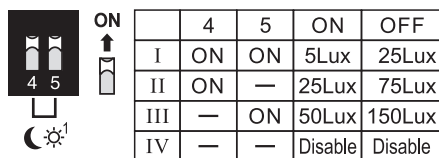

🕒^B Stand-by periode

Bij de +∞ instelling zal het armatuur gedimd gaan branden op basis van de instelling bij ☀️¹ en de hoeveelheid omgevingslicht. Bij bewegingsdetectie gaat het lichtniveau gedurende de nalooptijd naar 100%.

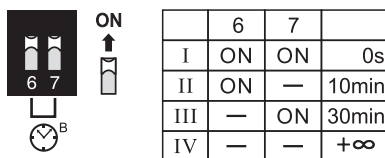

ⓓ Stand-by Dim niveau

Instelling van de lichtstroom bij gedimd lichtniveau.

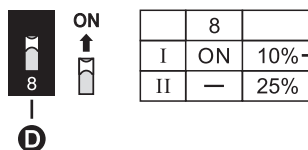

➔ Als de DIP-schakelaar op 'Stand-by periode' op +∞ staat, is de standaardinstelling 10% en kan niet worden gewijzigd.

MICROWAVE SENSOR - VOORBEELDEN VAN INSTELLINGEN

A 0% / 100% / 10% of 25%

Uit bij voldoende omgevingslicht --> 's-avonds/'s-nachts na bewegingsdetectie 100% gedurende nalooptijd
en 10%/25% gedurende stand-by tijd --> daarna uit

1

Uit bij voldoende daglicht, ook na detectie.

2

100% gedurende nalooptijd, bij detectie en onvoldoende daglicht.

3

Na afloop nalooptijd naar 10%/25% gedurende stand-by tijd.

4

Uit na afloop stand-by tijd.



Stand-by periode (gedimd licht)



	6	7	
I	ON	ON	0s
II	ON	—	10min
III	—	ON	30min
IV	—	—	+∞



Daglicht



	4	5	ON	OFF
I	ON	ON	5Lux	25Lux
II	ON	—	25Lux	75Lux
III	—	ON	50Lux	150Lux
IV	—	—	Disable	Disable

B 0% / 100%

Uit bij voldoende omgevingslicht --> 's-avonds/'s-nachts na bewegingsdetectie 100% gedurende nalooptijd --> daarna uit

1

Uit bij voldoende daglicht, ook na detectie.

2

100% gedurende nalooptijd, bij detectie en onvoldoende daglicht.

3

Uit na afloop nalooptijd.



Stand-by periode (gedimd licht)



	6	7	
I	ON	ON	0s
II	ON	—	10min
III	—	ON	30min
IV	—	—	+∞



Daglicht



	4	5	ON	OFF
I	ON	ON	5Lux	25Lux
II	ON	—	25Lux	75Lux
III	—	ON	50Lux	150Lux
IV	—	—	Disable	Disable

MICROWAVE SENSOR - VOORBEEDEN VAN INSTELLINGEN

C 10% / 100%

Altijd aan op gedimd niveau --> na detectie 100% gedurende nalooptijd

1



Overdag: gedimd niveau.

2

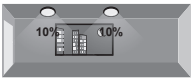



'S-avonds/'s-nachts:
gedimd niveau.

3





100% gedurende nalooptijd,
bij detectie.



 **Stand-by periode** (gedimd licht)

 ON ↑ 

	6	7	
I	ON	ON	0s
II	ON	—	10min
III	—	ON	30min
IV	—	—	+∞

 ✓

 **Daglicht**

 ON ↑ 

	4	5	ON	OFF
I	ON	ON	5Lux	25Lux
II	ON	—	25Lux	75Lux
III	—	ON	50Lux	150Lux
IV	—	—	Disable	Disable

 ✓

D 0% / 10% op basis van daglicht / 100% bij beweging

Gedimd niveau aan/uit op basis van daglicht en 100% bij detectie

1



Uit bij voldoende daglicht,
ook na detectie.

2

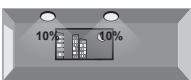

'S-avonds/'s-nachts:
aan op gedimd niveau.

3



100% gedurende nalooptijd,
bij detectie.

5



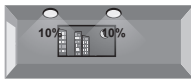

Uit bij voldoende daglicht,
ook na detectie.

4





'S-avonds/'s-nachts:
aan op gedimd niveau.



 **Stand-by periode** (gedimd licht)

 ON ↑ 

	6	7	
I	ON	ON	0s
II	ON	—	10min
III	—	ON	30min
IV	—	—	+∞

 ✓

 **Daglicht**

 ON ↑ 

	4	5	ON	OFF
I	ON	ON	5Lux	25Lux
II	ON	—	25Lux	75Lux
III	—	ON	50Lux	150Lux
IV	—	—	Disable	Disable

 ✓ ✓ ✓

MASTER/SLAVE FUNCTIE

Centraal geschakeld

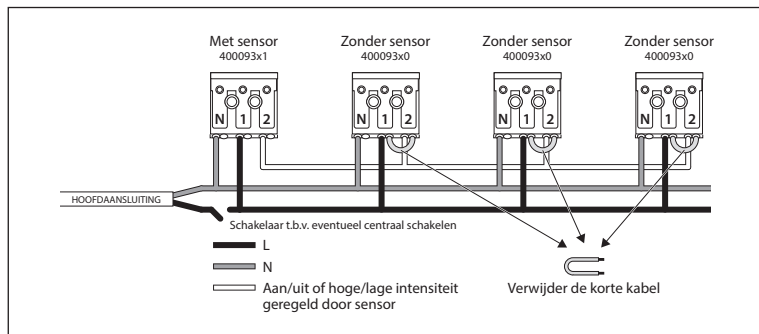
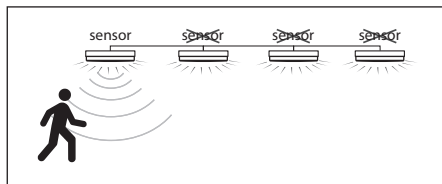

 **Het aantal units in slave-functie is gelimiteerd (max. 30 stuks).**

MONTAGE

1. Draai de afscherming los.
2. Haal het aansluitsnoer door de thule en fixeer met de trekcontlasting.
3. Bevestig het armatuur d.m.v. schroeven op de ondergrond.
4. Sluit het aansluitsnoer correct aan op de terminal.
5. Bevestig de afscherming.

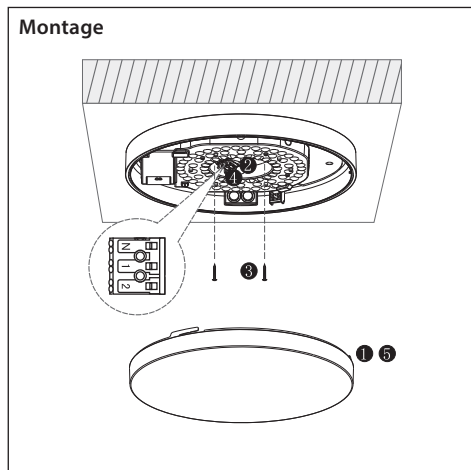

4 Aansluiting kabel



Zonder sensor

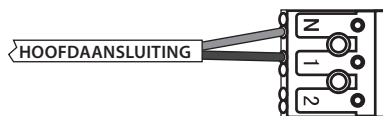

Met sensor
(geschakelde fase niet verplicht)

KEUZE LICHTOPBRENGST

U kunt het armatuur instellen op 2 of 3 verschillende Lumen waarden.

De schakelaar is te vinden op de LED module en is te zien wanneer u de beschermingskap heeft verwijderd.

ON

↑

Prodisc III Mini
2 keuzes uit
Lumen waarden

	1	
I	ON	100%
II	-	50%

ON

↑

Prodisc III
3 keuzes uit
Lumen waarden

	1	2	
I	ON	ON	100%
II	ON	-	70%
III	-	-	50%

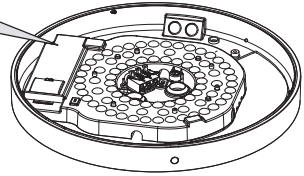

KEUZE LICHTKLEUR

U kunt het armatuur instellen op 2 verschillende lichtkleuren.

De schakelaar is te vinden op de LED module en is te zien wanneer u de beschermingskap heeft verwijderd.

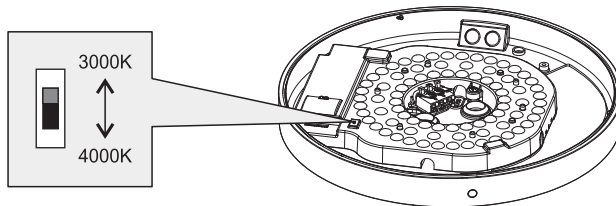

ONDERHOUD

1. Maak het armatuur spanningsloos.
2. Gebruik geen chemische schoonmaakmiddelen om de lamp te reinigen.

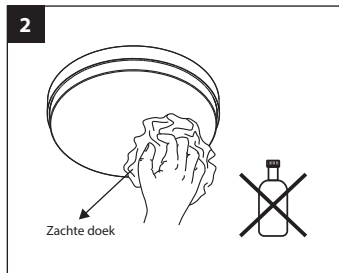
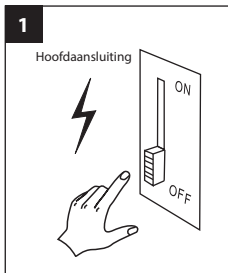

BESCHERMING VAN HET MILIEU

Defecte elektrische apparaten behoren niet te worden weggegooid bij het huishoudelijk afval. Recycle waar mogelijk. Neem contact op met uw gemeente of uw leverancier voor een deskundig recycling advies.



NL

EN

FR

CZ

DE

ATTENTION

Please read the following instructions carefully to ensure that mounting operation will be carried out correctly. These instructions should be properly preserved for future reference.

CAUTION

1. The product must be installed by qualified technicians. The power supply must be cut before installation.
2. The installation wiring must be 2 x 1.0 mm² at least and wired in accordance with the latest IEE electrical regulations or the national requirements.
3. Do not touch the LEDs while installing or maintaining.
4. This product contains a light source of energy efficiency class E.

TECHNICAL DATA

Supply voltage: AC 220-240V 50/60Hz

Light source: LED SMD2835

Operating temperature: -25°C – +50°C (Sensor version: -25°C – +40°C)

Electrical safety class: Class II

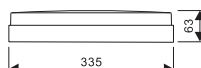

Prodisc III



Prodisc III Mini

TECHNICAL INFORMATION

Article no.	Voltage	LED type	Power	Light output	MW sensor
-------------	---------	----------	-------	--------------	-----------

White version

40009370	220-240V 50/60Hz	SMD2835	15W	850Lm / 1190Lm / 1700Lm	-
40009371	220-240V 50/60Hz	SMD2835	16.5W	850Lm / 1190Lm / 1700Lm	Yes
40009380	220-240V 50/60Hz	SMD2835	9W	485Lm / 970Lm	-
40009381	220-240V 50/60Hz	SMD2835	10.5W	485Lm / 970Lm	Yes

Black version

40009375	220-240V 50/60Hz	SMD2835	15W	750Lm / 1125Lm / 1500Lm	-
40009376	220-240V 50/60Hz	SMD2835	16.5W	750Lm / 1125Lm / 1500Lm	Yes
40009385	220-240V 50/60Hz	SMD2835	9W	440Lm / 880Lm	-
40009386	220-240V 50/60Hz	SMD2835	10.5W	440Lm / 880Lm	Yes

MICROWAVE SENSOR - DESCRIPTION

Detection zone max. (d x h): 12m x 6m

Detection sensitivity: 50% or 100%, adjustable

Hold time: 5sec - 10min, adjustable

Daylight on: 5 - 50Lux, adjustable or disabled

Daylight off: 25 - 150Lux, adjustable or disabled

Stand-by period (low light level): 0 sec - +∞ min, adjustable

Stand-by dim level: 10% or 25%, adjustable

Ceiling mounting height: 6m max.

Motion detection (threshold): 0.3 ~ 3m/s

Detection angle: 150° (wall installation), 360° (ceiling installation)

Wall mounting detection area (m)
Suggested installation height: 2m

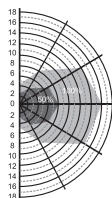

Walking speed: 0.3m/s

Ceiling mounting detection area (m)
Suggested installation height: 3m

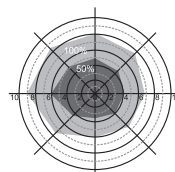

Walking speed: 0.3m/s

MICROWAVE SENSOR - PARAMETER SETTINGS

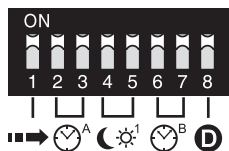

➡ Detection Area

This determines the effective range of the motion detector and is set with DIP switches on the driver. Note that reducing the sensitivity will also narrow the detection range.

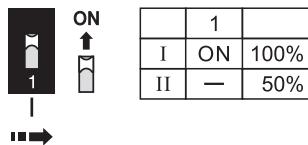

⌚^A Hold Time

This determines the time the fixture remains at 100% and is set with DIP switches on the driver. The walk test (5s) setting is useful when installing the fixture to establish correct operation and range.

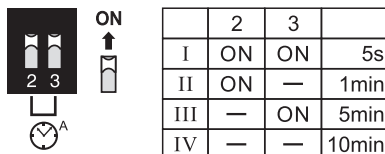

☀¹ Daylight

With this setting it can be determined at what daylight level the luminaire will or will not be switched on when motion is detected. The photocell functionality can also be disabled.

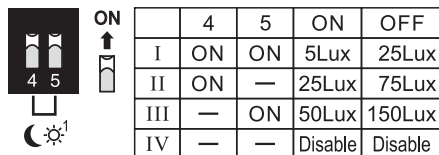

⌚^B Stand-by period

With the +∞ setting, the fixture will light up dimmed based on the setting of ☀¹ and the amount of ambient light. With motion detection, the light level goes to 100% during the hold time.

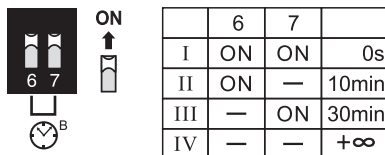

ⓓ Stand-by Dim level

Adjustment of the luminous flux with dimmed light level.

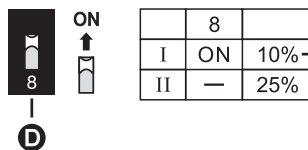

When the DIP switch is set to +∞ on 'Stand-by period', the default setting is 10% and can't be changed.

MICROWAVE SENSOR -EXAMPLES OF SETTINGS

A 0% / 100% / 10% or 25%

Off with sufficient ambient light --> in the evening / at night after motion detection 100% during hold time and 10% / 25% during stand-by time --> then off

1

Off with sufficient daylight, even after detection.

2

100% during hold time, upon detection and insufficient daylight.

3

After hold time to 10%/25% during stand-by time.

4

Off after the end of standby time.



Stand-by period (dimmed light)



	6	7	
I	ON	ON	0s
II	ON	—	10min
III	—	ON	30min
IV	—	—	+∞



Daylight



	4	5	ON	OFF
I	ON	ON	5Lux	25Lux
II	ON	—	25Lux	75Lux
III	—	ON	50Lux	150Lux
IV	—	—	Disable	Disable



B 0% / 100%

Off with sufficient ambient light --> in the evening / at night after motion detection 100% during hold time --> then off

1

Off with sufficient daylight, even after detection.

2

100% during hold time, upon detection and insufficient daylight.

3

Off after hold time.



Stand-by period (dimmed light)



	6	7	
I	ON	ON	0s
II	ON	—	10min
III	—	ON	30min
IV	—	—	+∞



Daylight



	4	5	ON	OFF
I	ON	ON	5Lux	25Lux
II	ON	—	25Lux	75Lux
III	—	ON	50Lux	150Lux
IV	—	—	Disable	Disable



MICROWAVE SENSOR - EXAMPLES OF SETTINGS

C 10% / 100%

Always on at dimmed level --> after detection 100% during hold time

1

Daytime: dimmed level.

2

In the evening/at night:
dimmed level.

3

100% during hold time,
upon detection.

Stand-by period (dimmed light)

	6	7	
I	ON	ON	0s
II	ON	—	10min
III	—	ON	30min
IV	—	—	+∞

✓

Daylight

	4	5	ON	OFF
I	ON	ON	5Lux	25Lux
II	ON	—	25Lux	75Lux
III	—	ON	50Lux	150Lux
IV	—	—	Disable	Disable

✓

D 0% / 10% based upon daylight / 100% when triggered

Dimmed level on/off based on daylight and 100% on detection

1

Off with sufficient daylight,
even after detection.

2

In the evening/at night:
on at dimmed level.

3

100% during hold time,
upon detection.

4

In the evening/at night:
on at dimmed level.

5

Off with sufficient daylight,
even after detection.

Stand-by period (dimmed light)

	6	7	
I	ON	ON	0s
II	ON	—	10min
III	—	ON	30min
IV	—	—	+∞

✓

Daylight

	4	5	ON	OFF
I	ON	ON	5Lux	25Lux
II	ON	—	25Lux	75Lux
III	—	ON	50Lux	150Lux
IV	—	—	Disable	Disable

✓
✓
✓

MASTER/SLAVE FUNCTION

Central switched

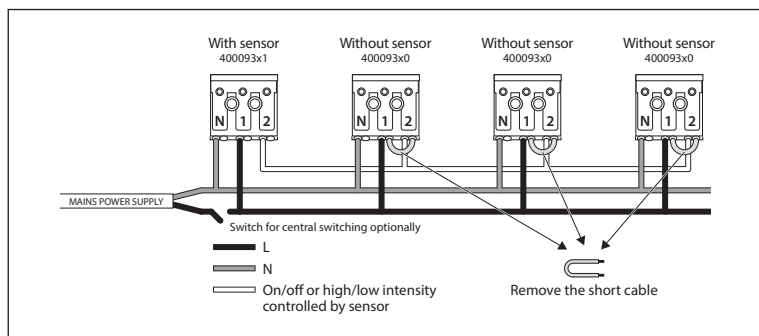
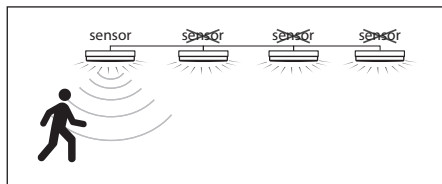

The number of slaves is limited (max. 30 pcs).

MOUNTING

1. Disassemble the diffuser.
2. Pull the power cord through the gasket.
3. Fix the fixture on the surface with screws.
4. Connect the power cord on the terminal correctly.
5. Assemble the diffuser.

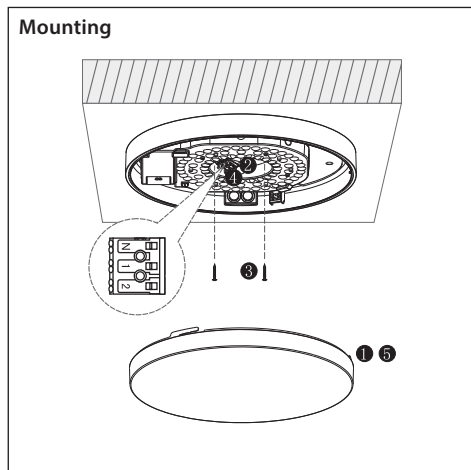

4 Cable connection

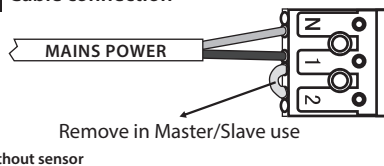

Without sensor

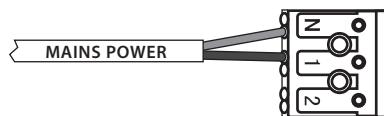

With sensor
(switched phase not required)

OPTIONAL OUTPUT BRIGHTNESS

There are 2 or 3 choices of output brightness by different setting on the surface of the LED light engine. The switch can be found on the LED module and can be seen when you have removed the protective cap.

ON

Prodisc III Mini
2 choices of output brightness

	1	
I	ON	100%
II	-	50%

ON

Prodisc III
3 choices of output brightness

	1	2	
I	ON	ON	100%
II	ON	-	70%
III	-	-	50%

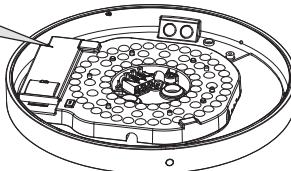

OPTIONAL COLOR TEMPERATURE

There are 2 choices of color temperature by different setting on the surface of the LED light engine. The switch can be found on the LED module and can be seen when you have removed the protective cap.

3000K

↕

4000K

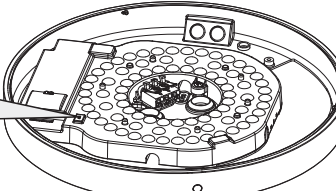

MAINTENANCE

1. Cut off the mains power first.
2. Don't use chemical reagent to clean lamp.

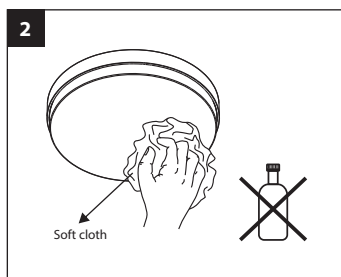
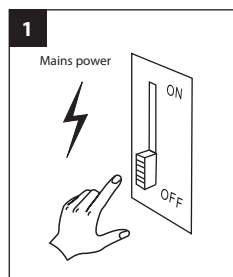

ENVIRONMENTAL PROTECTION

Waste electrical products should not be disposed of with household waste. Please recycle where facilities exist. Check with your local authority or retailer for recycling advice.



NL

EN

FR

CZ

DE

ATTENTION

Lisez attentivement les instructions suivantes pour vous assurer que les travaux d'installation sont effectués correctement. Conservez ces instructions en toute sécurité pour une utilisation future possible.

ATTENTION

1. Le produit doit être installé par des personnes qualifiées. L'installation doit être mise hors tension avant l'installation.
2. Le câble d'installation doit avoir au moins 2 x 1,0 mm² et doit être raccordé conformément aux dernières réglementations électriques de l'IEE ou selon les exigences nationales.
3. Ne touchez pas les voyants pendant l'installation ou la maintenance.
4. Ce produit contient une source lumineuse de classe d'efficacité énergétique E.

DONNÉES TECHNIQUES

Tension d'alimentation: AC 220-240V 50/60Hz
 Source de lumière: LED SMD2835
 Température de fonctionnement: -25°C – +50°C
 (Version capteur: -25°C – +40°C)
 Classe de protection électrique: Classe II

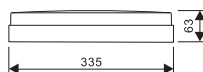

Prodisc III

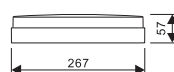

Prodisc III Mini

INFORMATIONS TECHNIQUES

Numéro article	Tension d'alimentation	Type LED	Puissance	Flux lumineux	Capteur
----------------	------------------------	----------	-----------	---------------	---------

Version blanche

40009370	220-240V 50/60Hz	SMD2835	15W	850Lm / 1190Lm / 1700Lm	-
40009371	220-240V 50/60Hz	SMD2835	16,5W	850Lm / 1190Lm / 1700Lm	Oui
40009380	220-240V 50/60Hz	SMD2835	9W	485Lm / 970Lm	-
40009381	220-240V 50/60Hz	SMD2835	10,5W	485Lm / 970Lm	Oui

Version noire

40009375	220-240V 50/60Hz	SMD2835	15W	750Lm / 1125Lm / 1500Lm	-
40009376	220-240V 50/60Hz	SMD2835	16,5W	750Lm / 1125Lm / 1500Lm	Oui
40009385	220-240V 50/60Hz	SMD2835	9W	440Lm / 880Lm	-
40009386	220-240V 50/60Hz	SMD2835	10,5W	440Lm / 880Lm	Oui

CAPTEUR DE MICRO-ONDES - DESCRIPTION

Plage de détection maxi (D x H): 12m x 6m
 Sensibilité de détection: 50% ou 100%, réglable
 Temps de combustion: 5sec - 10min, réglable
 Lumière du jour: 5 - 50Lux, réglable ou désactivé
 Lumière du jour désactivé: 25 - 150Lux, réglable ou désactivé
 Période de stand-by (faible niveau de lumière):
 0 sec - +∞, réglable
 Niveau d'atténuation stand-by: 10% ou 25%, réglable
 Hauteur de montage plafond: 6m max.
 Détection de mouvement (seuil): 0,3 ~ 3m/s
 Angle de détection: 150° (montage mural),
 360° (montage au plafond)

Portée de détection (m) montage au plafond
 Hauteur de montage proposée: 3m

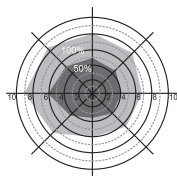

Vitesse de mouvement: 0,3m/s

Portée de détection (m) montage mural
 Hauteur de montage proposée: 2m

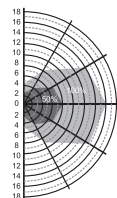

Vitesse de mouvement: 0,3m/s

CAPTEUR DE MICRO-ONDES - RÉGLAGE DES PARAMÈTRES

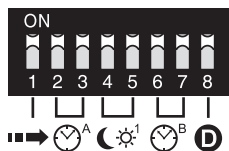

Plage de détection

Ceci détermine la portée effective du détecteur de mouvement et est réglé avec les micro-interrupteurs sur le pilote. Rendez-vous compte que réduire la sensibilité réduira également la plage de détection.

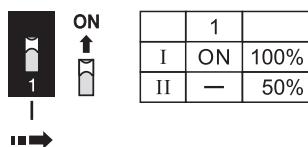

Temps de rodage

Cela détermine le temps pendant lequel le luminaire reste allumé au niveau de 100%. Cela peut être réglé avec des micro-interrupteurs sur le pilote. Lors de l'installation du luminaire, le réglage du test de marche (5s) est utile pour déterminer le fonctionnement et la portée corrects.

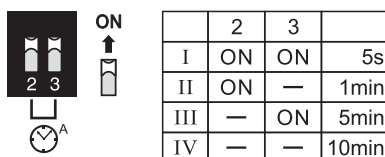

Lumière de jour

Avec ce réglage, il est possible de déterminer à quel niveau de lumière du jour le luminaire s'allumera ou ne sera pas allumé lorsqu'un mouvement est détecté. La fonctionnalité photocellule peut également être désactivée.

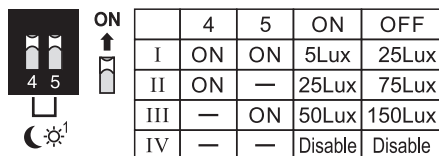

Période de stand-by

Avec le réglage +∞, le luminaire s'allumera en atténuation en fonction du réglage ☀¹ et de la quantité de lumière ambiante. Avec la détection de mouvement, le niveau de lumière passe à 100% pendant le temps de rodage.

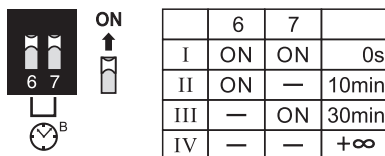

D Niveau d'atténuation stand-by

Réglage du flux lumineux avec un niveau de lumière atténuée.

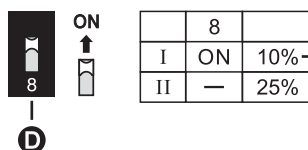

Lorsque le commutateur DIP est réglé sur +∞ sur 'Période stand-by', le réglage par défaut est 10% et ne peut pas être modifié.

CAPTEUR MICROWAVE - EXEMPLES DE PARAMETRES

A 0% / 100% / 10% ou 25%

Éteint en cas de lumière ambiante suffisante -> soir / nuit après détection de mouvement 100% pendant le temps de rodage et 10% / 25% pendant le temps de stand-by -> puis éteint

1



Éteint en cas de lumière du jour suffisante, même après détection.

2



100% pendant le temps de rodage, en cas de détection et de lumière du jour insuffisante.

3



Après le temps de rodage à 10% / 25% pendant le temps de stand-by.

4

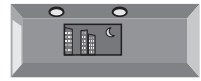

Éteint après temps de stand-by.

B Période de stand-by (lumière atténuée)

	6	7		
	I	ON	ON	0s
	II	ON	—	10min
	III	—	ON	30min
IV	—	—	+∞	

✓
✓

Lumière de jour

	4	5	ON	OFF
	I	ON	ON	5Lux 25Lux
	II	ON	—	25Lux 75Lux
	III	—	ON	50Lux 150Lux
IV	—	—	Disable	Disable

✓
✓
✓

B 0% / 100%

Éteint en cas de lumière ambiante suffisante -> soir / nuit après détection de mouvement 100% pendant le temps de rodage -> puis éteint

1



Éteint en cas de lumière du jour suffisante, même après détection.

2



100% pendant le temps de rodage, en cas de détection et de lumière du jour insuffisante.

3

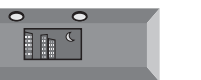

Éteint après le temps de rodage.

B Période de stand-by (lumière atténuée)

	6	7		
	I	ON	ON	0s
	II	ON	—	10min
	III	—	ON	30min
IV	—	—	+∞	

✓

Lumière de jour

	4	5	ON	OFF
	I	ON	ON	5Lux 25Lux
	II	ON	—	25Lux 75Lux
	III	—	ON	50Lux 150Lux
IV	—	—	Disable	Disable

✓
✓
✓

CAPTEUR MICROWAVE - EXEMPLES DE PARAMETRES

C 10% / 100%

Toujours activé sur un niveau atténué --> après détection 100% pendant le temps de rodage

1

Pendant la journée: niveau atténué.

2

Soir / Nuit: niveau atténué.

3

100% pendant le temps de rodage, en cas de détection.

B Période de stand-by (Lumière atténuée)

ON ↑

	6	7	
I	ON	ON	0s
II	ON	—	10min
III	—	ON	30min
IV	—	—	+∞

✓

1 Lumière de jour

ON ↑

	4	5	ON	OFF
I	ON	ON	5Lux	25Lux
II	ON	—	25Lux	75Lux
III	—	ON	50Lux	150Lux
IV	—	—	Disable	Disable

✓

D 0% / 10% en fonction de la lumière du jour / 100% en fonction du mouvement

Niveau atténué marche / arrêt basé sur la lumière du jour et 100% en cas de la détection

1

Éteint en cas de suffisamment de lumière du jour, même après détection.

2

Le soir/la nuit: activé a niveau atténué.

3

100% pendant le temps de rodage, en cas de détection.

5

Éteint en cas de suffisamment de lumière du jour, même après détection.

4

Le soir/la nuit: activé a niveau atténué.

B Période de stand-by (Lumière atténuée)

ON ↑

	6	7	
I	ON	ON	0s
II	ON	—	10min
III	—	ON	30min
IV	—	—	+∞

✓

1 Lumière de jour

ON ↑

	4	5	ON	OFF
I	ON	ON	5Lux	25Lux
II	ON	—	25Lux	75Lux
III	—	ON	50Lux	150Lux
IV	—	—	Disable	Disable

✓
✓
✓

FONCTION MAÎTRE / ESCLAVE

Commutation centralisée

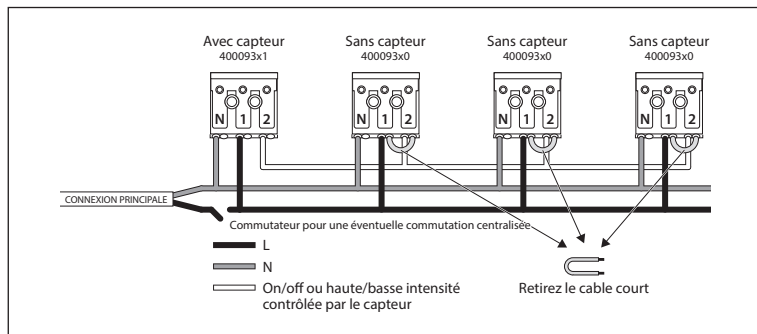
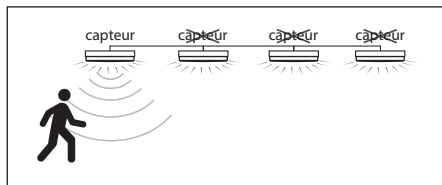

! Le nombre d'unités dans la fonction esclave est limité (max. 30 pièces).

INSTALLATION

1. Dévissez le blindage.
2. Passer le câble à travers le thule et le fixer avec le réducteur de tension.
3. Fixez l'appareil au moyen de vis sur la surface.
4. Connectez le câble de connexion au terminal correctement.
5. Fixez le blindage.

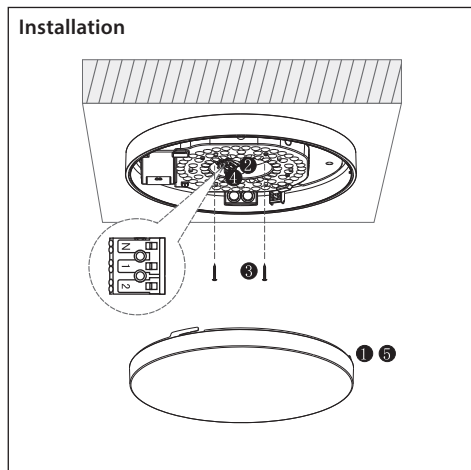

4 Câble de connexion

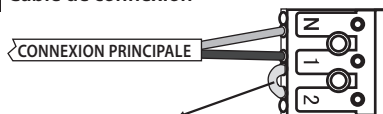

Supprimer en cas d'utilisation maître / esclave
Sans capteur

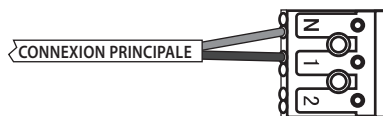

Avec capteur
(phase commutée non requise)

CHOIX DE LA SORTIE DE LUMIÈRE

Vous pouvez définir l'appareil à 2 ou 3 valeurs Lumen différentes.

L'interrupteur se trouve à côté du module LED et peut être vu lorsque vous avez retiré le capuchon de protection.

ON Prodisc III Mini
2 choix parmi les valeurs Lumen

	I		
I	ON	100%	
II	-	50%	

ON Prodisc III
3 choix parmi les valeurs Lumen

	I	2	
I	ON	ON	100%
II	ON	-	70%
III	-	-	50%

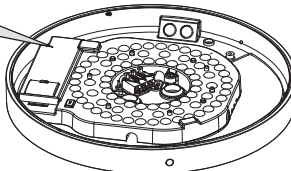

CHOIX DE LA TEMPÉRATURE DE COULEUR

Vous pouvez régler le luminaire sur 2 températures de couleur différentes.

L'interrupteur se trouve à côté du module LED et peut être vu lorsque vous avez retiré le capuchon de protection.

3000K

↕

4000K

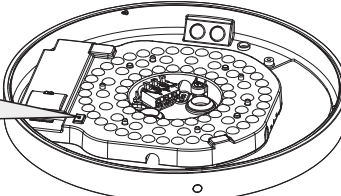

ENTRETIEN

1. Couper la tension du luminaire.
2. N'utilisez pas de produits de nettoyage chimiques pour nettoyer le luminaire.

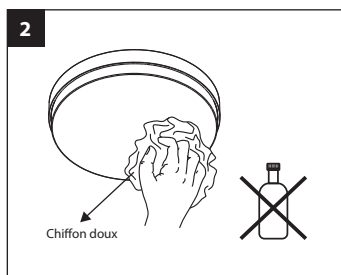
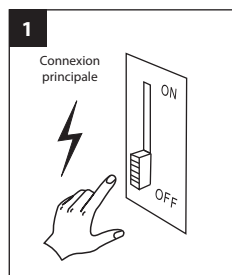

PROTECTION DE L'ENVIRONNEMENT

Les appareils électriques défectueux ne doivent pas être jetés avec les ordures ménagères. Recycler si possible. Contactez votre municipalité ou votre fournisseur pour obtenir des conseils spécialisés en matière de recyclage.



NL

EN

FR

CZ

DE

UPOZORNĚNÍ

Prosíme, přečtěte si pozorně návod k použití před začátkem instalace. Tento návod k použití si uchovejte pro případnou budoucí potřebu.

UPOZORNĚNÍ

1. Instalace může být provedena pouze kvalifikovaným pracovníkem. Přívod proudu musí být odpojen před začátkem instalace.
2. Průřez vodičů připojovacího vedení musí být min. $2 \times 1,0 \text{ mm}^2$ a zapojení dle IEE mezinárodních elektrických regulací.
3. Nedotýkejte se LED diod během instalace ani při údržbě.
4. Tento výrobek obsahuje světelný zdroj s třídou energetické účinnosti E.

TECHNICKÁ DATA

Napájení: AC 220-240V 50/60Hz

Světelný zdroj: LED SMD2835

Provozní teplota: $-25^\circ\text{C} - +50^\circ\text{C}$ (Verze s čidlem: $-25^\circ\text{C} - +40^\circ\text{C}$)

Třída ochrany: Třída II

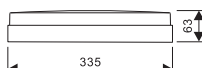

Prodisc III



Prodisc III Mini

TECHNICKÉ INFORMACE

Obj.č.	Napájení	Typ LED	Příkon	Světelný tok	Senzor
--------	----------	---------	--------	--------------	--------

Bílá verze

40009370	220-240V 50/60Hz	SMD2835	15W	850Lm / 1190Lm / 1700Lm	-
40009371	220-240V 50/60Hz	SMD2835	16,5W	850Lm / 1190Lm / 1700Lm	Ano
40009380	220-240V 50/60Hz	SMD2835	9W	485Lm / 970Lm	-
40009381	220-240V 50/60Hz	SMD2835	10,5W	485Lm / 970Lm	Ano

Černá verze

40009375	220-240V 50/60Hz	SMD2835	15W	750Lm / 1125Lm / 1500Lm	-
40009376	220-240V 50/60Hz	SMD2835	16,5W	750Lm / 1125Lm / 1500Lm	Ano
40009385	220-240V 50/60Hz	SMD2835	9W	440Lm / 880Lm	-
40009386	220-240V 50/60Hz	SMD2835	10,5W	440Lm / 880Lm	Ano

MIKROVLNNÝ SENZOR - POPIS

Detekční zóna max. (š x v): 12m x 6m

Citlivost detekce: 50% nebo 100% - nastavitelné

Doba plného osvětlení: 5s - 10min - nastavitelné

Denní osvětlení zap.: 5 - 50Lux, nastavitelné nebo vyp.

Denní osvětlení vyp.: 25 - 150Lux, nastavitelné nebo vyp.

Pohotovostní režim (nízká míra osvětlení):

0 s - $+\infty$ min, nastavitelné

Stupeň strmivání v pohotovostním režimu:

10% or 25%, nastavitelné

Výška stropní montáže: 6m max.

Detektor pohybu (práh): 0.3 ~ 3m/s

Úhel detekce: 150° (nástěnná montáž),

360° (stropní montáž)

Oblast detekce při stropní montáži (m)
Doporučená montážní výška: 3m

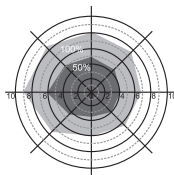

Rychlost pohybu: 0,3m/s

Oblast detekce při nástěnné montáži (m)
Doporučená montážní výška: 2m

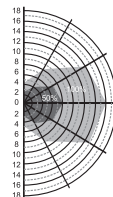

Rychlost pohybu: 0,3m/s

NASTAVENÍ PARAMETRŮ MV SENZORU

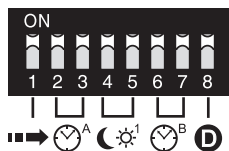

Oblast detekce

To určuje efektivní dosah detektoru pohybu a nastavuje se pomocí DIP switch přepínačů na ovladači. Pamatujte, že snížení citlivosti také zúží rozsah detekce.

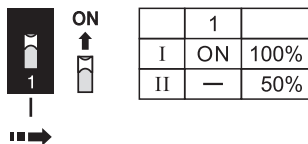

Doba plného osvětlení

Určuje dobu, po kterou zařízení zůstane nastaveno na 100% osvětlení a je nastaveno pomocí přepínačů DIP switch na ovladači. Nastavení testu chůze (5 s) je užitečné při instalaci zařízení pro zajištění správné funkce a dosahu.

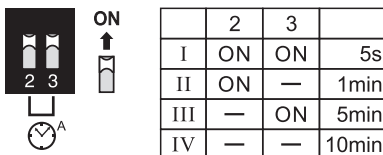

Režim denního osvětlení

S tímto nastavením lze určit na jaké úrovni denního světla se svítidlo zapne nebo naopak nespustí, když je detekován pohyb. Funkci fotobuňky lze také deaktivovat.

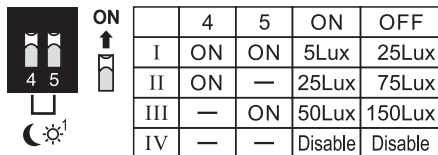

Pohotovostní režim

S nastavením +∞ se zařízení rozsvítí tlumeně na základě nastavení ☀️ a míře okolního osvětlení. S detekcí pohybu se míra osvětlení během doby stand by zvýší na 100%.

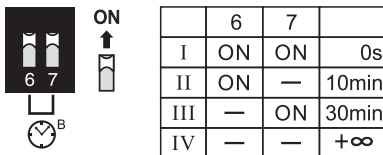

Stupeň stmívání v pohotovostním režimu

Úprava světelného toku s úrovní tlumeného světla.

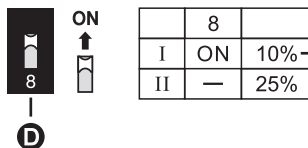

Když je přepínač DIP switch nastaven na +∞ v „Pohotovostním režimu“, výchozí nastavení je 10% a nelze jej změnit.

MIKROVLNNÉ ČIDLO – PŘÍKLAD NASTAVENÍ

A 0% / 100% / 10% nebo 25%

Vypnuto s dostatečným atmosférickým osvětlením -> večer / v noci po detekci pohybu 100% během doby zadržení a 10% / 25% během doby pohotovosti -> poté vypnuto

1

Vypnuto s dostatečným denním osvětlením, a to i po detekci pohybu.

2

100% během doby osvětlení, při detekci a nedostatečném denním osvětlení.

3

Po době osvětlení na 10% / 25% během pohotovostního režimu.

4

Po skončení pohotovostního režimu vypnuto.



Pohotovostní doba (tlumené osvětlení)



ON



	6	7	
I	ON	ON	0s
II	ON	—	10min
III	—	ON	30min
IV	—	—	+∞



Režim denního osvětlení



ON



	4	5	ON	OFF
I	ON	ON	5Lux	25Lux
II	ON	—	25Lux	75Lux
III	—	ON	50Lux	150Lux
IV	—	—	Disable	Disable



B 0% / 100%

Vypnuto s dostatečným atmosférickým osvětlením -> večer / v noci po detekci pohybu 100% během doby osvětlení -> poté vypnuto

1

Vypnuto s dostatečným denním osvětlením, a to i po detekci pohybu.

2

100% během doby osvětlení, při detekci a nedostatečném denním osvětlení.

3

Vypnuto po době osvětlení.



Pohotovostní doba (tlumené osvětlení)



ON



	6	7	
I	ON	ON	0s
II	ON	—	10min
III	—	ON	30min
IV	—	—	+∞



Režim denního osvětlení



ON



	4	5	ON	OFF
I	ON	ON	5Lux	25Lux
II	ON	—	25Lux	75Lux
III	—	ON	50Lux	150Lux
IV	—	—	Disable	Disable



MIKROVLNNÉ ČIDLO – PŘÍKLAD NASTAVENÍ

C 10% / 100%

Vždy zapnuto na tlumené úrovni -> po detekci pohybu 100% během doby osvětlení

1

Denní: tlumená úroveň.

2

Večer / v noci: tlumená úroveň.

3

100% během doby osvětlení, po detekci.

Pohotovostní doba (tlumené osvětlení)

ON ↑

	6	7	
I	ON	ON	0s
II	ON	—	10min
III	—	ON	30min
IV	—	—	+∞

✓

Režim denního osvětlení

ON ↑

	4	5	ON	OFF
I	ON	ON	5Lux	25Lux
II	ON	—	25Lux	75Lux
III	—	ON	50Lux	150Lux
IV	—	—	Disable	Disable

✓

D 0% / 10% na základě denního osvětlení / 100% při spuštění

Úroveň stmívání zapnuto / vypnuto na základě denního osvětlení a 100% při detekci pohybu

1

Vypnuto s dostatečným denním osvětlením, a to i po detekci pohybu.

2

Večer / v noci: zapnuto na tlumené úrovni.

3

100% během doby osvětlení, po detekci.

4

Večer / v noci: zapnuto na tlumené úrovni.

5

Vypnuto s dostatečným denním osvětlením, a to i po detekci pohybu.

Pohotovostní doba (tlumené osvětlení)

ON ↑

	6	7	
I	ON	ON	0s
II	ON	—	10min
III	—	ON	30min
IV	—	—	+∞

✓

Režim denního osvětlení

ON ↑

	4	5	ON	OFF
I	ON	ON	5Lux	25Lux
II	ON	—	25Lux	75Lux
III	—	ON	50Lux	150Lux
IV	—	—	Disable	Disable

✓
✓
✓

FUNKCE MASTER/SLAVE

Centrální spínání

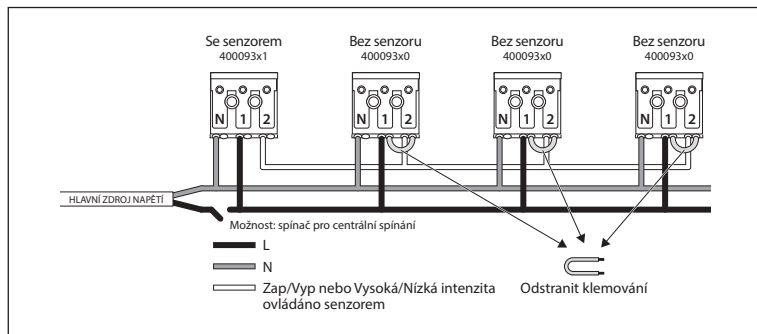
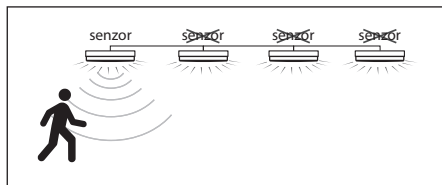

⚠ Počet svítidel ve funkci Slave je omezen (max. 30 ks).

MONTÁŽ

1. Odmontujte difuzor.
2. Protáhněte přívodní kabel otvorem v krytu svítidla.
3. Umístěte svítidlo na požadované místo a zafixujte.
4. Správně zapojte kabel ke svorce.
5. Připevněte difuzor.

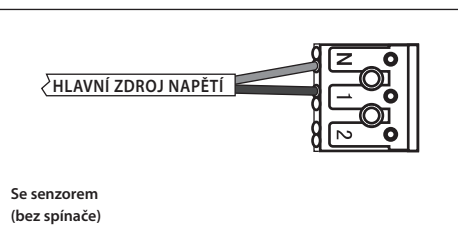
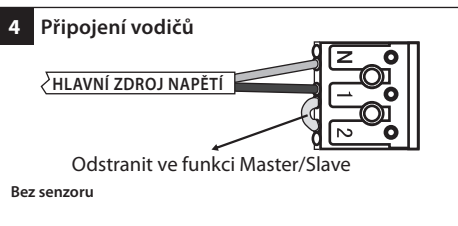
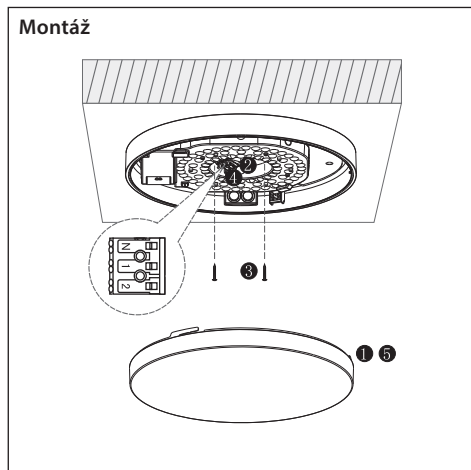

MOŽNOSTI NASTAVENÍ SVÍTIVOSTI

Možnost nastavení 2-3 úrovní jasu ovládané přepínačem na LED panelu. Přepínač je umístěn vedle LED modulu a je dostupný po odstranění ochranného krytu.

ON ↑

Prodisc III Mini
2 úrovně jasu

	1	
I	ON	100%
II	-	50%

ON ↑

Prodisc III
3 úrovně jasu

	1	2	
I	ON	ON	100%
II	ON	-	70%
III	-	-	50%

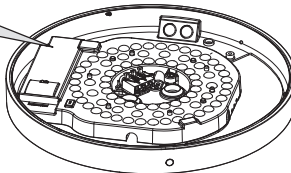

VOLITELNÁ TEPLOTA CHROMATIČNOSTI

K dispozici 2 možnosti nastavení teploty chromatičnosti pomocí přepínače umístěného přímo na svítidle. Přepínač je umístěn vedle LED modulu a je dostupný po odstranění ochranného krytu.

3000K

↕

4000K

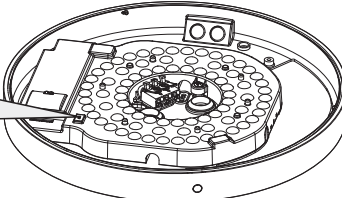

ÚDRŽBA

1. Nejprve vypněte přívod proudu.
2. Nepoužívejte chemické čisticí prostředky.

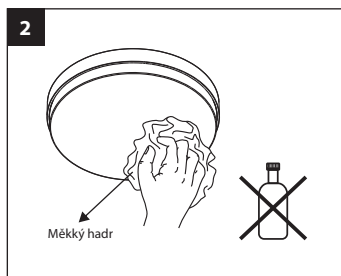
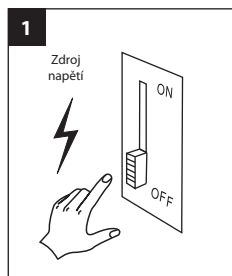

OCHRANA ŽIVOTNÍHO PROSTŘEDÍ

Vyřazené elektronické přístroje nepatří do směsného odpadu. Prosíme recyklujte na místech tomu určených. Případně se poradte s místním úřadem nebo svým prodejcem.



NL

EN

FR

CZ

DE

ACHTUNG

Lesen Sie die folgende Anleitung bitte aufmerksam durch, um eine korrekte Ausführung der Montage zu gewährleisten. Bewahren Sie diese Anleitung zum späteren Nachschlagen gut auf.

HINWEIS

1. Das Produkt muss durch einen qualifizierten Techniker installiert werden. Die Installation muss, vor der Montage, bei abgeschalteter Versorgungsspannung vorgenommen werden.
2. Die Leitung zur Spannungsversorgung muss einen Mindestquerschnitt von $2 \times 1,0 \text{ mm}^2$ aufweisen und entsprechend den neusten IEE-Vorschriften oder den nationalen Vorschriften angeschlossen sein.
3. LEDs bei Installation und Wartung nicht berühren.
4. Dieses Produkt enthält eine Lichtquelle der Energieeffizienzklasse E.

TECHNISCHE DATEN

Betriebsspannung: AC 220-240V 50/60Hz

Lichtquelle: LED SMD2835

Betriebstemperatur: $-25^\circ\text{C} - +50^\circ\text{C}$ (Sensorausführung: $-25^\circ\text{C} - +40^\circ\text{C}$)

Schutzklasse: Klasse II

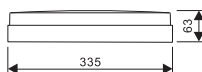

Prodisc III

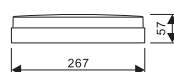

Prodisc III Mini

TECHNISCHE INFORMATIONEN

Artikelnr.	Betriebsspannung	LED-Typ	Leistung	Lichtstrom	Sensor
------------	------------------	---------	----------	------------	--------

Weißer Version

40009370	220-240V 50/60Hz	SMD2835	15W	850Lm / 1190Lm / 1700Lm	-
40009371	220-240V 50/60Hz	SMD2835	16,5W	850Lm / 1190Lm / 1700Lm	Ja
40009380	220-240V 50/60Hz	SMD2835	9W	485Lm / 970Lm	-
40009381	220-240V 50/60Hz	SMD2835	10,5W	485Lm / 970Lm	Ja

Schwarze Version

40009375	220-240V 50/60Hz	SMD2835	15W	750Lm / 1125Lm / 1500Lm	-
40009376	220-240V 50/60Hz	SMD2835	16,5W	750Lm / 1125Lm / 1500Lm	Ja
40009385	220-240V 50/60Hz	SMD2835	9W	440Lm / 880Lm	-
40009386	220-240V 50/60Hz	SMD2835	10,5W	440Lm / 880Lm	Ja

MIKROWELLEN-SENSOR - BESCHREIBUNG

Ansprechbereich max. (T x H): 12m x 6m

Ansprechempfindlichkeit: 50% oder 100%, einstellbar

Leuchtdauer: 5sec - 10 Minuten, einstellbar

Tageslicht an: 5 - 50Lux, einstellbar oder ausschalten

Tageslicht aus: 25 - 150Lux, einstellbar oder ausschalten

Nachlaufzeit (Orientierungsbeleuchtung):

0 sec - $+\infty$ min (einstellbar)

Orientierungsbeleuchtung: 10% oder 25% (einstellbar)

Montagehöhe: max. 6 m

Bewegungserkennung: 0,3 ~ 3m/s

Erkennungswinkel: 150° (Wandmontage),

360° (Deckenmontage)

Ansprechbereich (m) Deckenmontage
Empfohlene Montagehöhe: 3m

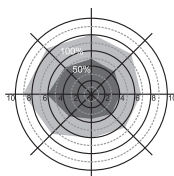

Bewegungsgeschwindigkeit: 0,3m/s

Ansprechbereich (m) Wandmontage
Empfohlene Montagehöhe: 2m

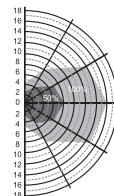

Bewegungsgeschwindigkeit: 0,3m/s

MIKROWELLEN-SENSOR - EINSTELLEN DER PARAMETER

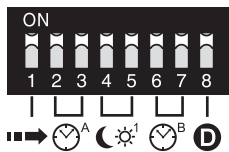

Ansprechbereich

Diese Einstellung bestimmt den Ansprechbereich des Bewegungsmelders. Hierzu dienen die DIP-Schalter am Sensor, siehe Abbildung unten. Beachten Sie bitte, dass sich bei geringerer Empfindlichkeit auch der Ansprechbereich verkleinert.

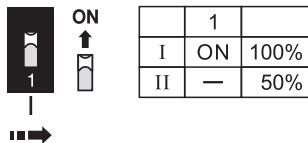

Laufzeit

Dies ist die Zeit, während der die Leuchte mit 100% Helligkeit leuchtet. Die Einstellung erfolgt an den DIP-Schaltern am Sensor, siehe Abbildung unten. Während der Installation der Leuchte ist die Einstellung Laufzeit (5s) eine praktische Hilfe, um die korrekte Funktion im gewünschten Bereich zu überprüfen.

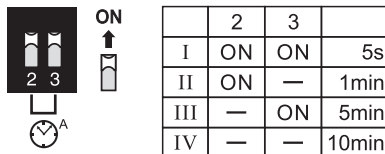

Tageslicht

Mit dieser Einstellung kann bestimmt werden, bei welchem Tageslichtniveau die Leuchte eingeschaltet wird oder nicht, wenn eine Bewegung erkannt wird. Die Photozellenfunktion kann auch deaktiviert werden.

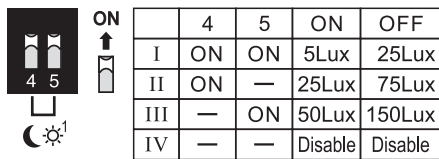

Nachlaufzeit, Orientierungsbeleuchtung

Mit der +∞-Einstellung Leuchtkraft bei 10%/25% abhängig von der ☀️-Einstellung, bei Bewegungserkennung 100% während der Laufzeit.

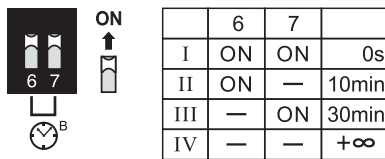

Standby-Dimmstufe

Einstellung des Lichtstroms bei gedimmtem Lichtniveau.

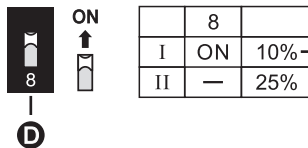

Wenn der DIP-Schalter auf +∞ bei 'Nachlaufzeit, Orientierungsbeleuchtung' eingestellt ist, beträgt die Standardeinstellung 10% und kann nicht geändert werden.

NL

EN

FR

CZ

DE

MIKROWELLEN-SENSOR - BEISPIELE FÜR EINSTELLUNGEN

A 0% / 100% / 10% oder 25%

AUS bei ausreichendem Umgebungslicht --> abends / nachts bei Bewegungserkennung 100% und während der Nachlaufzeit 10%/25% --> danach AUS

1

AUS bei ausreichendem Tageslicht, auch nach der Bewegungserkennung.

2

100% während der Laufzeit, bei Bewegungserkennung und unzureichendem Tageslicht.

3

Nach der Laufzeit auf 10%/25% während der Nachlaufzeit.

4

AUS nach dem Ende der Nachlaufzeit.



Nachlaufzeit, Orientierungsbeleuchtung



ON ↑

	6	7	
I	ON	ON	0s
II	ON	—	10min
III	—	ON	30min
IV	—	—	+∞



Tageslicht



ON ↑

	4	5	ON	OFF
I	ON	ON	5Lux	25Lux
II	ON	—	25Lux	75Lux
III	—	ON	50Lux	150Lux
IV	—	—	Disable	Disable



B 0% / 100%

AUS bei ausreichendem Umgebungslicht --> abends / nachts bei Bewegungserkennung 100% --> danach AUS

1

AUS bei ausreichendem Tageslicht, auch nach der Bewegungserkennung.

2

100% während der Laufzeit, bei Bewegungserkennung und unzureichendem Tageslicht.

3

AUS nach Laufzeit



Nachlaufzeit, Orientierungsbeleuchtung



ON ↑

	6	7	
I	ON	ON	0s
II	ON	—	10min
III	—	ON	30min
IV	—	—	+∞



Tageslicht



ON ↑

	4	5	ON	OFF
I	ON	ON	5Lux	25Lux
II	ON	—	25Lux	75Lux
III	—	ON	50Lux	150Lux
IV	—	—	Disable	Disable



MIKROWELLEN-SENSOR - BEISPIELE FÜR EINSTELLUNGEN

C 10% / 100%

Leuchte ist immer gedimmt (10%/25 %) --> abends / nachts bei Bewegungserkennung 100%

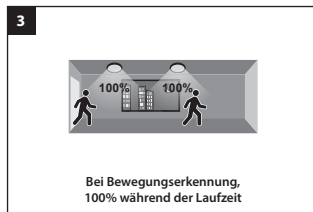
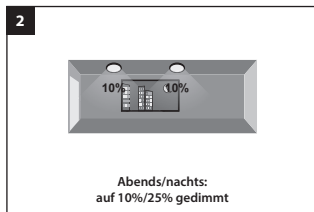
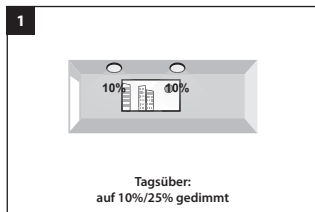

Nachlaufzeit, Orientierungsbeleuchtung **Tageslicht**

ON ↑	6	7		
6 7	I	ON	ON	0s
	II	ON	—	10min
	III	—	ON	30min
	IV	—	—	+∞

✓

ON ↑	4	5	ON	OFF
4 5	I	ON	ON	5Lux 25Lux
	II	ON	—	25Lux 75Lux
	III	—	ON	50Lux 150Lux
	IV	—	—	Disable Disable

✓

D 0% / 10% basierend auf Tageslicht / 100% bei Bewegungserkennung

Leuchte gedimmt basierend auf Tageslicht und bei Bewegungserkennung 100% während der Laufzeit

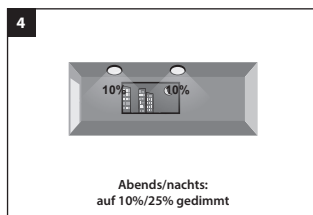
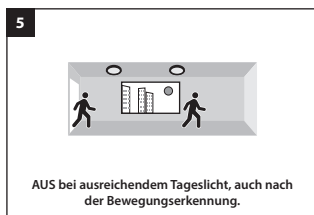
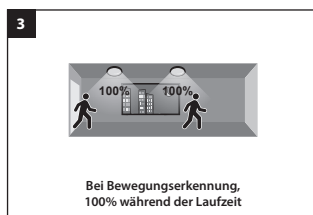
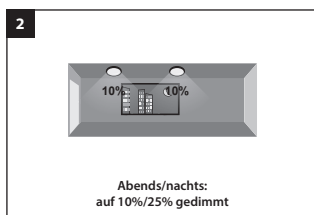
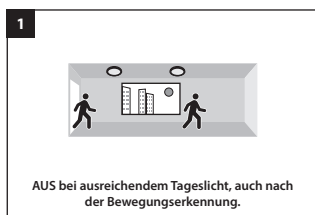

Nachlaufzeit, Orientierungsbeleuchtung **Tageslicht**

ON ↑	6	7		
6 7	I	ON	ON	0s
	II	ON	—	10min
	III	—	ON	30min
	IV	—	—	+∞

✓

ON ↑	4	5	ON	OFF
4 5	I	ON	ON	5Lux 25Lux
	II	ON	—	25Lux 75Lux
	III	—	ON	50Lux 150Lux
	IV	—	—	Disable Disable

✓
✓
✓

MASTER/SLAVE FUNKTION

Zentral geschaltet

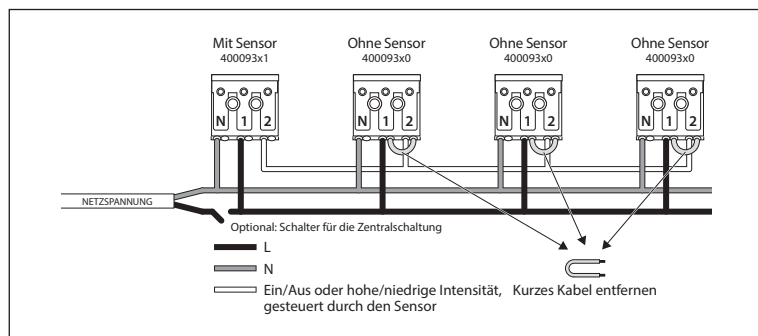
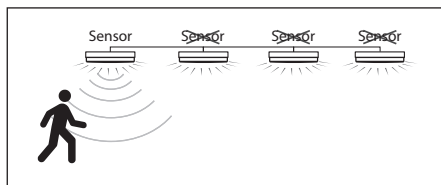

! Die Anzahl der Slaves ist begrenzt (max. 30 Stück).

MONTAGE

1. Schrauben Sie die Blende ab.
2. Führen Sie das Anschlusskabel durch die Tülle und fixieren Sie es mit der Zugentlastung.
3. Befestigen Sie die Leuchte mit Schrauben auf der Montagefläche.
4. Schließen Sie das Anschlusskabel korrekt an den Klemmen an.
5. Befestigen Sie die Blende.

Montage

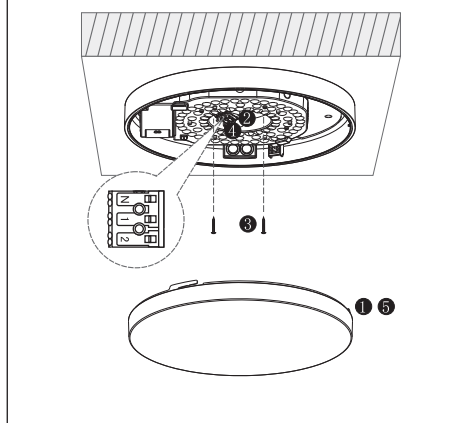

4 Anschluss des Kabels

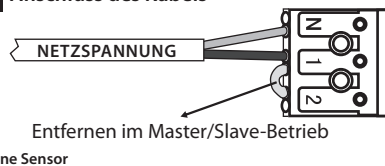

Ohne Sensor

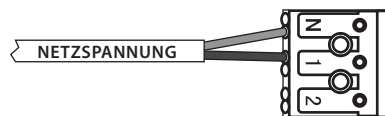

Mit Sensor
(geschaltete Phase nicht unbedingt erforderlich)

AUSWAHL DER HELLIGKEIT

Sie können an der Leuchte zwei oder drei verschiedene Lumen-Werte einstellen.
Der Schalter befindet sich neben dem LED-Modul und wird nach Abnehmen der Blende zugänglich.

ON Prodisc III Mini
2 Wahlmöglichkeiten der Ausgangshelligkeit

	1	
I	ON	100%
II	-	50%

ON Prodisc III
3 Wahlmöglichkeiten der Ausgangshelligkeit

	1	2	
I	ON	ON	100%
II	ON	-	70%
III	-	-	50%

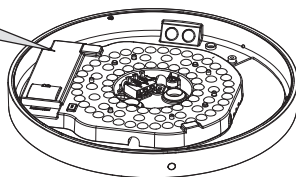

AUSWAHL DER FARBTEMPERATUR

Es gibt 2 mögliche Farbtemperaturen, die über einen Schalter auf dem LED-Panel eingestellt werden können.
Der Schalter befindet sich auf dem LED-Panel und wird nach Abnehmen der Blende zugänglich.

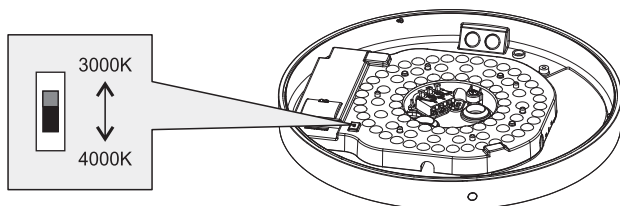

WARTUNG

1. Spannungsversorgung der Leuchte unterbrechen.
2. Zur Reinigung der Leuchte keine Chemikalien verwenden.

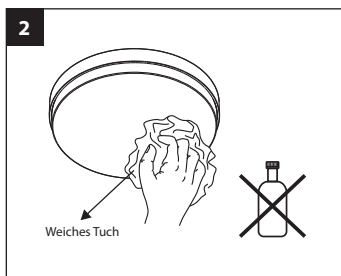

UMWELTSCHUTZ

Defekte Elektrogeräte dürfen nicht über den Hausmüll entsorgt werden. Führen Sie sie, falls möglich, dem Recycling zu.
Für weitere Hinweise zum Recycling wenden Sie sich bitte an Ihre Gemeinde oder Ihren Lieferanten.



NL

EN

FR

CZ

DE

PROLUMIA®

IMPORTER

NEDELKO B.V.

Riga 10

2993 LW BARENDRECHT

T +31 (0)180 64 54 00

E info@nedelko.nl

NEDELKO BELGIUM NV

Prins Boudewijnlaan 49

2650 EDEGEM

T +32 (0)3 826 99 99

E info@nedelko.be

NEDELKO S.R.O.

Ke Slivenci 48

154 00 PRAHA 5 - LOCHKOV

T +420 222 563 003

E info@nedelko.cz

NEDELKO GERMANY GMBH

Heinz-Bäcker-Str. 27

45356 ESSEN

T +49 (0)201 560503 50

E info@nedelko.de