

Product data sheet Spirotech

Product name

EMCM Duo-9 max 6,6bar Twin

Product properties

The MultiControl Modular DUO Twin is an automatic expansion and pressure-maintaining device. The unit contains 2 pumps (2x 50%) and 2 overflow valves. A separate storage tank is required.

- 2 pumps (2x 50%)
- 2 overflow valves (2x 100%)
- At least 1 unpressurized expansion vessel needs to be added
- Operational pressure range up to 4.0 to 16.0 bar
- The maximum temperature at the point of connection: 70°C (over 70°C possible with auxiliary tank)
- Maximum safety temperature in the system: 110°C
- Maximum operating pressure (PN) up to: 25 bar

Article number

EMCM-D9-6.6-twin

Product image



Product dimensions

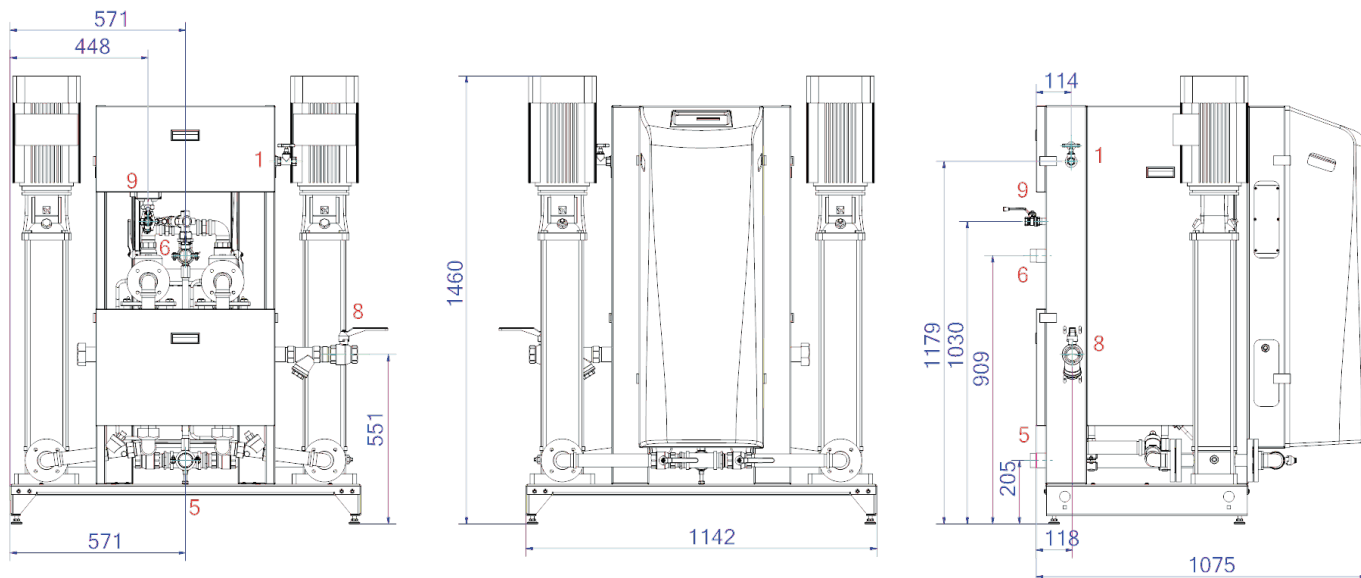

1. Refill connection

Rp1/2, Rp3/4

6. Overflow line to the expansion tank

R2

5. Suction line from expansion vessel

R6/4

8. Expansion pressure pipe

Rp2

Product data sheet Spirotech

ETIM product data

Height	1460 mm	Double pump	Yes
Max. operating pressure	6.6 bar	With exchangeable membrane	No
Connection	Other	Compressor in base	No
Power consumption	8.2 kW	Nominal diameter expansion connection	2 inch (50)
Couplable	Yes	Max. medium temperature (continuous)	70 °C
Electrical connection	Connection cable with plug	For heating systems up to	1 MW
Function master/slave	No	Horizontal positioning	No
With pressure expansion vessel	No	Connection voltage	400 V
Digital control unit	Yes	Article compression class	PN 16

Disclaimer

This product sheet has been compiled with the greatest possible care. Nevertheless, it may contain errors or omissions. For the most current and correct information we refer you to our website

