

**Installation avec conduites
composites eau potable /
chauffage / refroidissement**

**Liste des articles condensée
Benelux 01-2024**

uponor



uponor

Liste des articles condensée 2024 Benelux

Installation

Installation avec conduites composites

<i>Vue d'ensemble Uponor conduites de raccordement et techniques de raccordement</i>	5
Uponor MLC - conduites composites	6
Raccords	
Uponor S-Press PLUS PPSU	8
Uponor S-Press PLUS 14 mm	9
Uponor S-Press PLUS 16-75 mm	10
Uponor RS 63-110 mm	19
Uponor RTM 16-25 mm	20

Chauffage de surface, refroidissement de surface

Installation dans le sol pour nouvelle construction et travaux de rénovation

<i>Systèmes Uponor pour chauffer et refroidir</i>	22
<i>Conduites pour le chauffage/refroidissement de surface</i>	24

Systèmes Uponor pour chauffer et refroidir

Uponor 10 bar UFH Chauffage au sol	26
Uponor Minitec	27
Uponor Tecto	28
Uponor Nubos	30
Uponor Klett	31
Uponor Tacker	32
Uponor Fix	34
Uponor Classic	35
Uponor Comfort E	36
Uponor Siccus 14	37
Uponor Renovis	38
Uponor Siccus wall	40
Uponor Siccus SW	40
Uponor Thermatop	41
Uponor Multi	42
Conduites de distribution 25–75 mm	43

Techniques de collecteurs Uponor

<i>Vue d'ensemble des actionneurs</i>	44
Uponor Vario PLUS	45
Uponor Vario M	46
Uponor Vario S	47
<i>Cotes de montage armoires de distribution</i>	48

Régulations de la température de locaux individuels pour habitations

<i>individuels pour habitations</i>	50
<i>Eventail des fonctions Smatrix Wave/Base</i>	51
Uponor Smatrix Wave / Pulse	52
Uponor Smatrix Base / Pulse	54
Uponor Smatrix Base PRO	56
Uponor Base	56
Uponor Vario	57

Régulation Uponor de la température de départ / Groupes de pompes

Uponor Smatrix Move	58
Uponor Fluvia	59

Réseau terrestre – distribution

Système de distribution de chaleur et de froid Uponor Ecoflex

Uponor Ecoflex VIP Thermo	64
Uponor Ecoflex Thermo	64
Uponor Ecoflex VIP Aqua	65
Uponor Ecoflex Aqua	65
Uponor Ecoflex Quattro	65
Uponor Ecoflex Supra	66
Uponor Ecoflex Supra PLUS	67
Techniques de connexion	
Uponor Wipex	68
Uponor Q&E	70
Uponor Ecoflex Accessoires	71

Outillages

Uponor Dérouleur	73
Uponor outillages de coupe et de préparation	74
Uponor outillages pour pose chauffage sol	75
Uponor divers	76

Annexe

Télécharger la liste de prix en ligne complète :	79
--	----

Installation avec conduites composites

Installation eau potable / chauffage / refroidissement /
avec conduites composites Uponor

Installation

Chauffage de surface, refroidissement de surface

Installation dans le sol pour nouvelle construction et travaux de rénovation
Techniques de collecteurs Uponor
Régulation de la température ambiante
Régulation Uponor de la température de départ / Groupes de pompes

Chauffage surface

Reseau terrestre - distribution

Système de distribution de chaleur
et de froid Uponor Ecoflex

Distribution

Outillages Uponor

Dérouleurs, outillages de coupe et de préparation,
outillages d'expansion, de pose de chauffage sol et divers

Outillages Uponor

Annexe











Annexe

Vue d'ensemble Uponor conduites de raccordement

Différentes situations de montage et domaines d'application exigent des conceptions d'assemblage parfaitement adaptés. Pour cette raison, Uponor développe des produits, non seulement des conduites, mais aussi des systèmes de raccordement parfaitement adaptés à l'application prévue. La gamme de raccordement Uponor comprenant des raccords, des coudes, des raccords en T ainsi qu'un grand nombre de composants de système permettons un montage rapide, sûr et pratique, tout en dépassant les exigences imposées à une installation d'eau potable hygiénique et à une tuyauterie d'eau chaude contemporaine.

Uponor système de raccordement

Dimension/ Code couleur	Conduite du type composite
-------------------------------	-------------------------------

 14	MLC
 16	Uni Pipe PLUS
 20	Uni Pipe PLUS
 25	Uni Pipe PLUS
 32	Uni Pipe PLUS
 40	MLC
 50	MLC
 63	MLC
 75	MLC
 90	MLC
 110	MLC

Caractéristiques

Code couleur en fonction des dimensions

Regard pour contrôler la profondeur d'insertion

Marquage de sertissage
par détachement de la feuille du raccord

Marquage de sertissage
par détachement de la bague de butée

Marquage de sertissage
par impression sur les mâchoires à sertir

Montage sans ébavurage

Montage sans étalonnage

Raccord non serti, non étanche

Fonction de sertissage intégrée

Système de raccordement modulaire

Uponor Uni Pipe PLUS

N° art.	Dimension	UL	UE	unité
---------	-----------	----	----	-------

Uponor Uni Pipe PLUS blanc S

 1060783	16x2,0 3m	75	3	m
1059572	16x2,0 5m	125	5	m
1060784	20x2,25 3m	51	3	m
1059573	20x2,25 5m	85	5	m
1060785	25x2,5 3m	30	3	m
1059574	25x2,5 5m	50	5	m
1060786	32x3,0 3m	21	3	m
1059575	32x3,0 5m	35	5	m

Uponor MLC tube, blanc S

 1013448	40x4,0 3m	12	3	m
1088465	40x4,0 3,3m	13.2	3.3	m
1013446	40x4,0 5m	20	5	m
1021980	50x4,5 3m	12	3	m
1013449	50x4,5 5m	20	5	m
1021981	63x6,0 3m	9	3	m
1013451	63x6,0 5m	15	5	m
1013453	75x7,5 5m	255	5	m
1013455	90x8,5 5m	255	5	m
1013457	110x10,0 5m	165	5	m

Uponor Uni Pipe PLUS blanc

 1091638	16x2,0 10m	880	220	m
1091639	16x2,0 25m	1600	400	m
1059576	16x2,0 100m	2000	100	m
1092653	16x2,0 120m	2400	120	m
1059577	16x2,0 200m	2600	200	m
1059578	16x2,0 500m	3500	500	m
1092671	20x2,25 25m	900	225	m
1059579	20x2,25 100m	1300	100	m
1093124	20x2,25 500m	2000	500	m
1059581	25x2,5 50m	700	50	m
1059583	32x3,0 50m	400	50	m

Uponor MLC tube, blanc

 1013366	14x2,0 200m	2600	200	m
--	-------------	------	-----	---

N° art.	Dimension	UL	UE	unité
---------	-----------	----	----	-------

Uponor Uni Pipe PLUS isolé, blanc S4 WLS 040

 1091709	16x2,0 red 100m	800	100	m
1063553	16x2,0 blue 100m	800	100	m
1091710	20x2,25 red 100m	800	100	m
1063555	20x2,25 blue 100m	800	100	m
1091711	25x2,5 red 50m	400	50	m
1063946	25x2,5 blue 50m	400	50	m
1091712	32x3,0 red 50m	350	50	m
1091716	32x3,0 blue 50m	350	50	m

Uponor MLC tube isolé blanc S6

 1013577	14x2,0 red 50m	600	50	m
--	----------------	-----	----	---

Uponor Uni Pipe PLUS isolé, blanc S6 WLS 035

 1063556	16x2,0 blue 75m	600	75	m
1063557	20x2,25 blue 75m	600	75	m
1063558	25x2,5 blue 50m	400	50	m

Uponor Uni Pipe PLUS isolé, blanc S6 WLS 040

 1091713	16x2,0 red 75m	600	75	m
1091714	20x2,25 red 75m	600	75	m
1091715	25x2,5 red 50m	400	50	m
1091723	16x2,0 blue 75m	600	75	m
1091724	20x2,25 blue 75m	600	75	m
1091725	25x2,5 blue 50m	400	50	m

Uponor Uni Pipe PLUS tube pré-isolé en couronne S10 WLS 035

 1062181	16x2,0 blue 75m	450	75	m
1062182	20x2,25 blue 75m	525	75	m
1062183	25x2,5 blue 50m	350	50	m

Uponor Uni Pipe PLUS isolé, blanc DHS26

 1063562	20x2,25 blue 25m	200	25	m
--	------------------	-----	----	---

Uponor Uni Pipe PLUS

N° art.	Dimension	UL	UE	unité
---------	-----------	----	----	-------

Uponor Uni Pipe PLUS pré gainé

 1063061	16x2,0 - 25/20 red 75m	1125	75	m
1063059	16x2,0 - 25/20 blue 75m	1125	75	m
1063062	20x2,25 - 28/23 red 75m	900	75	m
1063060	20x2,25 - 28/23 blue 75m	900	75	m
1093128	25x2,5 - 40/32 red 50m	450	50	m
1093129	25x2,5 - 40/32 blue 50m	450	50	m

Uponor Uni Pipe PLUS pré gainé blanc Twin

 1091718	16x2,0 - 25/20 black 50m	650	50	m
--	--------------------------	-----	----	---

Uponor MLC tube blanc pré gainé

 1013678	14x2,0 - 25/20 red 75m	1125	75	m
--	------------------------	------	----	---

N° art.	Dimension	UL	UE	unité
---------	-----------	----	----	-------

Uponor Teck gaine black

 1012860	25/20 50m	2500	50	m
1012864	28/23 50m	2000	50	m
1012869	35/29 50m	1400	50	m
1012872	43/36 25m	600	25	m

Uponor Teck gaine blue

 1012859	25/20 50m	2500	50	m
1012863	28/23 50m	2000	50	m

Uponor Teck gaine red

 1012858	25/20 50m	2500	50	m
1012862	28/23 50m	2000	50	m

Uponor Teck cavaliers simples

 1135511	32	1600	200	pièce
1135512	32	1600	200	pièce

Uponor Teck cavaliers doubles

 1135513	32	1200	200	pièce
1135514	32	800	200	pièce

Uponor S-Press PLUS PPSU

N° art.	Dimension	UL	UE	unité
---------	-----------	----	----	-------

Uponor S-Press PLUS coude à sertir PPSU

 1039929	16-16		80	20	pièce
1039930	20-20		80	10	pièce
1039931	25-25		80	10	pièce
1039932	32-32		20	5	pièce

Uponor S-Press coude PPSU

 1046386	40-40		960	5	pièce
1046387	50-50		576	3	pièce
1032877	63-63		210	1	pièce
1032878	75-75		210	1	pièce

Uponor S-Press coude 45° PPSU

 1046388	40-40		960	5	pièce
1046389	50-50		576	3	pièce
1032879	63-63		192	1	pièce
1032880	75-75		192	1	pièce

Uponor S-Press PLUS manchon à sertir PPSU

 1039933	16-16		80	20	pièce
1039934	20-20		80	10	pièce
1039935	25-25		80	10	pièce
1039936	32-32		80	10	pièce

Uponor S-Press manchon égal PPSU

 1046401	40-40		960	5	pièce
1046402	50-50		576	3	pièce
1032881	63-63		384	1	pièce
1032882	75-75		384	1	pièce

Uponor S-Press PLUS manchon réduit PPSU

 1039937	20-16		80	20	pièce
1039938	25-16		80	10	pièce
1039939	25-20		80	10	pièce
1039940	32-25		80	10	pièce

Uponor S-Press manchon réduit PPSU

 1046406	50-40		576	3	pièce
1032883	63-40		384	1	pièce
1032884	63-50		384	1	pièce
1032885	75-50		384	1	pièce
1032886	75-63		384	1	pièce

Uponor S-Press manchon réduit PPSU

 1039941	40-25		960	5	pièce
1039942	40-32		960	5	pièce
1039943	50-32		1152	3	pièce

N° art.	Dimension	UL	UE	unité
---------	-----------	----	----	-------

Uponor S-Press PLUS T à sertir PPSU

 1039944	16-16-16		80	10	pièce
1039945	20-20-20		80	10	pièce
1039946	25-25-25		20	5	pièce
1039947	32-32-32		20	5	pièce

Uponor S-Press Té égal PPSU

 1046390	40-40-40		720	5	pièce
1046391	50-50-50		288	3	pièce
1032887	63-63-63		150	1	pièce
1032888	75-75-75		150	1	pièce

Uponor S-Press PLUS T réduit à sertir PPSU

 1039948	16-20-16		80	10	pièce
1039949	20-16-16		80	10	pièce
1039950	20-16-20		80	10	pièce
1039951	20-20-16		80	10	pièce
1039952	20-25-20		80	10	pièce
1039953	25-16-16		80	10	pièce
1039954	25-16-20		80	10	pièce
1039955	25-16-25		80	10	pièce
1039956	25-20-20		80	10	pièce
1039957	25-20-25		80	10	pièce
1039958	32-16-32		20	5	pièce
1039959	32-20-32		20	5	pièce
1039960	32-25-25		20	5	pièce
1039961	32-25-32		20	5	pièce

Uponor S-Press T réduit à sertir PPSU

 1039962	40-20-40		960	5	pièce
1039963	40-25-32		960	5	pièce
1039964	40-25-40		720	5	pièce
1039965	40-32-32		960	5	pièce
1039966	40-32-40		720	5	pièce
1039967	50-25-40		432	3	pièce
1039968	50-25-50		432	3	pièce
1039969	50-32-50		432	3	pièce

Uponor S-Press Té réduit PPSU

 1046400	50-40-50		288	3	pièce
1032889	63-25-63		150	1	pièce
1032890	63-32-63		150	1	pièce
1032891	63-40-63		150	1	pièce
1032892	75-32-75		150	1	pièce
1032893	75-40-75		150	1	pièce
1032894	75-50-75		150	1	pièce

Uponor S-Press PLUS 14

N° art.	Dimension	UL	UE	unité
---------	-----------	----	----	-------

Uponor S-Press raccord mâle

 1014513	14-R $\frac{1}{2}$ "MT	80	20	pièce
--	------------------------	----	----	-------

Uponor S-Press raccord femelle

 1014515	14-Rp $\frac{1}{2}$ "FT	80	20	pièce
--	-------------------------	----	----	-------

Uponor S-Press manchon

 1015154	14-14	80	10	pièce
--	-------	----	----	-------

Uponor S-Press manchon réduit

 1015162	16-14	80	20	pièce
--	-------	----	----	-------

Uponor S-Press Té

 1014886	14-14-14	80	10	pièce
--	----------	----	----	-------

Uponor S-Press Té réduit

 1014888	14-16-14	80	10	pièce
1014912	16-14-14	80	10	pièce
1014915	16-14-16	80	10	pièce

Uponor S-Press adaptateur

 1014511	14-15CU	80	10	pièce
--	---------	----	----	-------

N° art.	Dimension	UL	UE	unité
---------	-----------	----	----	-------

Uponor Smart Aqua culasse S-Press

 1015437	14-Rp $\frac{1}{2}$ "FT	40	10	pièce
--	-------------------------	----	----	-------

Uponor Smart Aqua adaptateur coudé S-Press

 1014654	14-12CU l=150mm	-	20	pièce
--	-----------------	---	----	-------

Uponor Smart Radi adapt. coudé revêtu S-Press

 1015615	14-15CU l=350mm	-	20	pièce
--	-----------------	---	----	-------

Uponor S-Press PLUS

N° art.	Dimension	UL	UE	unité
---------	-----------	----	----	-------

Uponor S-Press PLUS raccord mâle

 1070501	16-R $\frac{3}{8}$ "MT	80	20	pièce
1070502	16-R $\frac{1}{2}$ "MT	80	20	pièce
1070503	16-R $\frac{3}{4}$ "MT	120	15	pièce
1070504	20-R $\frac{1}{2}$ "MT	80	20	pièce
1070505	20-R $\frac{3}{4}$ "MT	80	10	pièce
1070506	20-R1"MT	80	10	pièce
1070507	25-R $\frac{3}{4}$ "MT	80	10	pièce
1070508	25-R1"MT	40	5	pièce
1070509	32-R1"MT	40	5	pièce
1070510	32-R1 $\frac{1}{4}$ "MT	20	5	pièce

Uponor S-Press raccord mâle

 1046901	40-R1 $\frac{1}{4}$ "MT	960	5	pièce
1046902	40-R1 $\frac{1}{2}$ "MT	960	5	pièce
1046905	50-R1 $\frac{1}{2}$ "MT	1152	3	pièce
1046906	50-R2"MT	576	3	pièce
1032895	63-R2"MT	336	1	pièce
1032896	75-R2 $\frac{1}{2}$ "MT	336	1	pièce

Uponor S-Press PLUS raccord mâle BENELUX

 1070511	16-R15mm CU	80	20	pièce
1070512	20-R22mm CU	3840	10	pièce
1070513	25-R22mm CU	3840	10	pièce

Uponor S-Press PLUS raccord femelle

 1070515	16-Rp $\frac{1}{2}$ "FT	80	20	pièce
1070516	20-Rp $\frac{1}{2}$ "FT	120	15	pièce
1070517	20-Rp $\frac{3}{4}$ "FT	80	10	pièce
1070518	20-Rp1"FT	80	20	pièce
1070519	25-Rp $\frac{3}{4}$ "FT	40	5	pièce
1070520	25-Rp1"FT	40	5	pièce
1070521	32-Rp1"FT	40	5	pièce
1070522	32-Rp1 $\frac{1}{4}$ "FT	20	5	pièce

Uponor S-Press raccord femelle

 1046903	40-Rp1 $\frac{1}{4}$ "FT	960	5	pièce
1046904	40-Rp1 $\frac{1}{2}$ "FT	960	5	pièce
1046907	50-Rp1 $\frac{1}{2}$ "FT	1152	3	pièce

N° art.	Dimension	UL	UE	unité
---------	-----------	----	----	-------

Uponor S-Press PLUS coude à sertir

 1070523	16-16	80	20	pièce
1070524	20-20	80	10	pièce
1070525	25-25	40	5	pièce
1070526	32-32	20	5	pièce

Uponor S-Press coude

 1046908	40-40	600	5	pièce
1046911	50-50	240	3	pièce

Uponor S-Press PLUS courbe à sertir

 1070527	16-16	80	10	pièce
1070528	20-20	80	10	pièce
1070529	25-25	40	5	pièce
1070530	32-32	20	5	pièce

Uponor S-Press PLUS coude filetage mâle

 1070531	16-R $\frac{3}{8}$ "MT	80	20	pièce
1070532	16-R $\frac{1}{2}$ "MT	80	20	pièce
1070533	20-R $\frac{1}{2}$ "MT	80	10	pièce
1070534	20-R $\frac{3}{4}$ "MT	80	10	pièce
1070535	25-R $\frac{3}{4}$ "MT	40	5	pièce
1070536	25-R1"MT	40	5	pièce
1070537	32-R1"MT	20	5	pièce

Uponor S-Press coude fileté mâle

 1046909	40-R1 $\frac{1}{4}$ "MT	500	5	pièce
--	-------------------------	-----	---	-------

Uponor S-Press PLUS

N° art.	Dimension	UL	UE	unité
---------	-----------	----	----	-------

Uponor S-Press PLUS coude à sertir - CU

 1070538	16-G¾"MT/10CU		20	1 pièce
--	---------------	--	----	---------

Uponor S-Press PLUS coude fil. femelle

 1070539	16-Rp½"FT		80	10 pièce
1070540	20-Rp½"FT		80	10 pièce
1070541	20-Rp¾"FT		40	10 pièce
1070542	25-Rp¾"FT		20	5 pièce
1070543	25-Rp1"FT		20	5 pièce
1070544	32-Rp1"FT		20	5 pièce

Uponor S-Press coude fileté femelle

 1046910	40-Rp1 ½"FT		500	5 pièce
1046912	50-Rp1 ½"FT		300	3 pièce

Uponor S-Press PLUS coude à sertir 45°

 1070545	25-25		20	5 pièce
1070546	32-32		20	5 pièce

Uponor S-Press coude 45°

 1046913	40-40		500	5 pièce
1046914	50-50		300	3 pièce

N° art.	Dimension	UL	UE	unité
---------	-----------	----	----	-------

Uponor S-Press PLUS manchon à sertir

 1070547	16-16		80	20 pièce
1070548	20-20		80	10 pièce
1070549	25-25		80	10 pièce
1070550	32-32		40	5 pièce

Uponor S-Press PLUS manchon coulissant

 1118706	16-16		80	10 pièce
1118707	20-20		80	10 pièce
1118708	25-25		40	5 pièce
1118709	32-32		20	5 pièce

Uponor S-Press manchon coulissant

 1118710	40-40		12	3 pièce
--	-------	--	----	---------

Uponor S-Press couplage

 1046932	40-40		960	5 pièce
1046935	50-50		576	3 pièce

Uponor S-Press PLUS manchon réduit

 1070552	20-16		80	20 pièce
1070553	25-16		80	10 pièce
1070554	25-20		80	10 pièce
1070555	32-20		80	10 pièce
1070556	32-25		80	10 pièce

Uponor S-Press manchon réduit

 1046930	40-25		960	5 pièce
1046931	40-32		960	5 pièce
1046933	50-32		1152	3 pièce
1046934	50-40		576	3 pièce

Uponor S-Press PLUS

N° art.	Dimension	UL	UE	unité
---------	-----------	----	----	-------

Uponor S-Press PLUS T à sertir

 1070560	16-16-16		80	10 pièce
1070561	20-20-20		80	10 pièce
1070562	25-25-25		20	5 pièce
1070563	32-32-32		20	5 pièce

Uponor S-Press té égal

 1046921	40-40-40		400	5 pièce
1046928	50-50-50		300	3 pièce

Uponor S-Press PLUS T réduit

 1070566	16-20-16		80	10 pièce
1070567	20-16-16		40	10 pièce
1070568	20-16-20		80	20 pièce
1070569	20-20-16		80	20 pièce
1070570	20-25-16		40	10 pièce
1070571	20-25-20		40	10 pièce
1070572	25-16-16		40	5 pièce
1070573	25-16-20		40	5 pièce
1070574	25-16-25		20	5 pièce
1070575	25-20-16		40	5 pièce
1070576	25-20-20		40	5 pièce
1070577	25-20-25		20	5 pièce
1070578	25-25-16		20	5 pièce
1070579	25-32-25		20	5 pièce
1070580	32-16-32		20	5 pièce
1070581	32-20-32		20	5 pièce
1070582	32-25-25		20	5 pièce
1070583	32-25-32		20	5 pièce

Uponor S-Press T réduit

 1046916	40-20-40		400	5 pièce
1046917	40-25-32		500	5 pièce
1046918	40-25-40		400	5 pièce
1046919	40-32-32		400	5 pièce
1046920	40-32-40		400	5 pièce
1046924	50-25-40		300	3 pièce
1046925	50-25-50		240	3 pièce
1046926	50-32-50		300	3 pièce
1046927	50-40-50		300	3 pièce

Uponor S-Press PLUS T filetage mâle

 1070592	16-R $\frac{3}{2}$ "MT-16		40	10 pièce
1070593	25-R $\frac{3}{4}$ "MT-25		20	5 pièce
1070594	32-R $\frac{3}{4}$ "MT-32		20	5 pièce

N° art.	Dimension	UL	UE	unité
---------	-----------	----	----	-------

Uponor S-Press PLUS T filetage femelle

 1070595	16-Rp $\frac{1}{2}$ "FT-16		40	10 pièce
1070596	20-Rp $\frac{1}{2}$ "FT-20		60	15 pièce
1070597	20-Rp $\frac{3}{4}$ "FT-20		40	10 pièce
1070598	25-Rp $\frac{1}{2}$ "FT-25		20	5 pièce
1070599	25-Rp $\frac{3}{4}$ "FT-25		20	5 pièce
1070600	32-Rp $\frac{1}{2}$ "FT-32		20	5 pièce
1070601	32-Rp $\frac{3}{4}$ "FT-32		20	5 pièce

Uponor S-Press té femelle

 1046922	40-Rp $\frac{1}{2}$ "FT-40		500	5 pièce
1046923	40-Rp $\frac{3}{4}$ "FT-40		400	5 pièce
1046929	50-Rp1"FT-50		240	3 pièce

Uponor S-Press PLUS adapt. écrou tourn.

 1070708	16-G $\frac{3}{8}$ "SN		25	1 pièce
1070602	16-G $\frac{1}{2}$ "SN		30	1 pièce
1070603	16-G $\frac{3}{4}$ "SN		20	1 pièce
1070604	20-G $\frac{1}{2}$ "SN		20	1 pièce
1070605	20-G $\frac{3}{4}$ "SN		20	1 pièce
1070606	25-G $\frac{3}{4}$ "SN		15	1 pièce
1070607	25-G1"SN		15	1 pièce
1070608	25-G1 $\frac{1}{4}$ "SN		10	1 pièce
1070609	32-G1"SN		10	1 pièce
1070610	32-G1 $\frac{1}{4}$ "SN		10	1 pièce

Uponor S-Press rac. à visser filet fem.

 1060094	40-G1 $\frac{1}{4}$ "SN		960	5 pièce
1046937	40-G1 $\frac{1}{2}$ "SN		960	5 pièce
1060095	50-G1 $\frac{1}{2}$ "SN		1152	3 pièce
1046939	50-G2"SN		576	3 pièce

Uponor S-Press PLUS coude écrou tournant

 1070611	16-G $\frac{3}{8}$ "SN		20	1 pièce
1070612	16-G $\frac{1}{2}$ "SN		20	1 pièce
1105818	16-G $\frac{3}{4}$ "SN		10	1 pièce
1070613	20-G $\frac{1}{2}$ "SN		20	1 pièce
1105819	20-G $\frac{3}{4}$ "SN		10	1 pièce
1070614	25-G $\frac{3}{4}$ "SN		10	1 pièce

Uponor S-Press PLUS culasse murale M

 1070638	16-Rp $\frac{3}{8}$ "FT		40	10 pièce
1070639	16-Rp $\frac{1}{2}$ "FT		40	10 pièce
1070640	20-Rp $\frac{1}{2}$ "FT		40	10 pièce
1070641	20-Rp $\frac{3}{4}$ "FT		20	5 pièce
1070642	25-Rp $\frac{3}{4}$ "FT		20	5 pièce

Uponor S-Press PLUS

N° art.	Dimension	UL	UE	unité
---------	-----------	----	----	-------

Uponor S-Press PLUS culasse murale L

 1070644	16-Rp½"FT	40	10	pièce
1070645	20-Rp½"FT	40	10	pièce

Uponor S-Press PLUS culasse murale XL

 1070646	16-Rp½"FT	40	10	pièce
1070647	20-Rp½"FT	40	10	pièce

Uponor S-Press PLUS Sound set 2 panneaux muraux

 1121193	16-20	192	1	Kit
--	-------	-----	---	-----

Uponor S-Press PLUS culasse mur. + cache

 1070643	16-Rp¾"FT	20	1	pièce
--	-----------	----	---	-------

Uponor S-Press PLUS culasse murale Gemini

 1070665	16-Rp½"FT	4800	75	pièce
--	-----------	------	----	-------

Uponor S-Press PLUS culasse en U

 1070629	16-Rp½"FT-16	20	5	pièce
1070630	20-Rp½"FT-20	960	5	pièce
1070631	20-Rp½"FT-16	960	5	pièce
1070632	16-Rp½"FT-20	960	5	pièce
1070633	25-Rp½"FT-25	576	3	pièce
1070634	25-Rp½"FT-20	576	3	pièce

Uponor S-Press PLUS raccord U mitigeur

 1070636	16-16-R½"MT	960	5	pièce
1070637	20-20-R¾"MT	960	5	pièce

Uponor S-Press PLUS culasse double 90° long

 1070648	16-Rp½"FT-16	40	10	pièce
1070649	20-Rp½"FT-20	40	10	pièce

N° art.	Dimension	UL	UE	unité
---------	-----------	----	----	-------

Uponor S-Press PLUS culasse coudée pour chasse WC encastrée

 1070657	16-Rp½"FT	10	1	pièce
--	-----------	----	---	-------

Uponor S-Press PLUS raccord en T Geberit

 1070659	16-G½"FT-16	10	1	pièce
--	-------------	----	---	-------

Uponor S-Press PLUS coude pour réservoir Geberit

 1070658	16-½"FT	80	20	pièce
--	---------	----	----	-------

Uponor S-Press PLUS bouchon à sertir

 1070621	16	160	40	pièce
1070622	20	7680	20	pièce
1070623	25	3840	10	pièce
1070624	32	1920	5	pièce

Uponor S-Press PLUS bouchon test de pression

 1013754	14	7680	20	pièce
1013756	16	7680	20	pièce
1013760	20	3840	20	pièce
1013762	25	3840	10	pièce
1013764	32	3840	10	pièce
1013765	40	960	5	pièce

Uponor S-Press PLUS joint torique racc. à sertir

 1013798	14	10000	10	pièce
1013799	16	1000	10	pièce
1013801	20	1000	10	pièce
1013802	25	500	10	pièce
1013803	32	500	10	pièce
1013804	40	-	10	pièce

Uponor S-Press PLUS Unité de montage avec kit son

 1070666	16-Rp½"FT c/c150mm	150	5	pièce
--	--------------------	-----	---	-------

Uponor S-Press PLUS unité mont. culasses

 1070661	16-Rp½"FT c/c80mm	5	1	pièce
1070662	16-Rp½"FT c/c150mm	380	5	pièce

Uponor S-Press PLUS unité mont. culasses Gemini

 1070663	16-Rp½"FT c/c120mm	720	5	pièce
1070664	16-Rp½"FT c/c150mm	720	5	pièce

Uponor S-Press PLUS

N° art.	Dimension	UL	UE	unité
---------	-----------	----	----	-------

Uponor S-Press PLUS canne coudée



1070650	16-15CU l=150mm	2880	20	pièce
1070651	16-12CU l=150mm	2880	20	pièce

Uponor S-Press PLUS traversée droite



1070652	16-G $\frac{1}{2}$ "FT	5	1	pièce
----------------	------------------------	---	---	-------

Uponor S-Press PLUS culasse LWC



1070654	16-Rp $\frac{1}{2}$ "FT l=35	5	1	pièce
----------------	------------------------------	---	---	-------

Uponor S-Press PLUS plaque de montage



1121197	80/150mm	5	1	pièce
----------------	----------	---	---	-------

Uponor S-Press PLUS étrier de montage



1121195	80/150mm	5	1	pièce
----------------	----------	---	---	-------

Uponor Smart Aqua étrier de montage Gemini



1059825	150mm	5	1	pièce
----------------	-------	---	---	-------

Uponor Smart Aqua équerre mont. simple



1057843		5	1	pièce
----------------	--	---	---	-------

Uponor Smart Aqua profilé de montage



1057844	2m	10	1	pièce
----------------	----	----	---	-------

Uponor Smart Aqua sup. de mont. outil de cintr.



1015424	2m	-	1	pièce
----------------	----	---	---	-------

Uponor Smart Aqua 10 goupilles + 20 vis



1057847		-	1	Kit
----------------	--	---	---	-----

N° art.	Dimension	UL	UE	unité
---------	-----------	----	----	-------

Uponor S-Press couplage sur inox/CU V



1090678	16-15CU-SST	10	1	pièce
1090679	20-22CU-SST	5	1	pièce
1090680	25-22CU-SST	5	1	pièce
1090681	32-28CU-SST	5	1	pièce

Uponor S-Press couplage sur inox/CU M



1090682	16-15CU-SST	10	1	pièce
1090683	20-22CU-SST	5	1	pièce
1090684	25-22CU-SST	5	1	pièce
1090685	32-28CU-SST	5	1	pièce

Uponor S-Press PLUS adaptateur à sertir



1070705	16-10CU	80	20	pièce
1070706	16-12CU	80	20	pièce
1070615	16-15CU	160	20	pièce
1070707	20-15CU	3840	10	pièce
1070616	20-18CU	40	10	pièce
1070617	20-22CU	60	15	pièce
1070618	25-22CU	20	5	pièce
1070619	25-28CU	1920	5	pièce
1070620	32-28CU	20	5	pièce

Uponor S-Press manchon réduit







1015172	18-16	80	20	pièce
1015185	20-18	80	10	pièce



Uponor S-Press PLUS

N° art.	Dimension	UL	UE	unité
---------	-----------	----	----	-------

Uponor S-Press PLUS T de croisement

 1070689	16-16-16		192	1 pièce
 1070690	20-16-16		192	1 pièce
 1070691	20-16-20		192	1 pièce
 1070692	20-20-20		192	1 pièce

Uponor Smart Radi boîte de connexion

 1013134	16 h=215mm		240	10 pièce
 1007077	16 h=240mm		240	10 pièce

Uponor S-Press PLUS canne coudée étamée

 1070678	16-15CU l=350mm		1680	20 pièce
1070679	16-15CU l=1000mm		400	20 pièce
1070680	25-22CU l=250mm		640	20 pièce

Uponor S-Press PLUS adap. pour plinthe

 1070693	16-G $\frac{1}{2}$ "MT-16		192	1 pièce
1070695	16-G $\frac{1}{2}$ "MT-0		192	1 pièce
1094219	0-G $\frac{1}{2}$ "MT-16		192	1 pièce
1070697	20-G $\frac{1}{2}$ "MT-20		192	1 pièce

Uponor S-Press PLUS angle de plinthe SL

 1014060	15x1		25	1 Kit
--	------	--	----	-------

Uponor S-Press PLUS unité mont. culasses radi

 1070684	16-Rp $\frac{1}{2}$ "FT c/c50mm		960	5 pièce
--	---------------------------------	--	-----	---------

Uponor Smart Radi adaptateur platine

 1015425	G $\frac{1}{2}$ "MT-15CU l=350mm		640	20 pièce
--	----------------------------------	--	-----	----------

N° art.	Dimension	UL	UE	unité
---------	-----------	----	----	-------

Uponor Smart Radi adaptateur

 1013830	15CU- $\frac{3}{4}$ " Euro		80	10 pièce
--	----------------------------	--	----	----------

Uponor Smart Radi adaptateur scellé

 1013906	G $\frac{3}{4}$ "MT-G $\frac{1}{2}$ "MT		80	10 pièce
--	---	--	----	----------

Uponor Smart Radi raccord à compression Danfoss

 1013970	16-G $\frac{1}{2}$ "MT		20	1 pièce
--	------------------------	--	----	---------

Uponor Smart Radi raccord à compression Heimeier

 1013978	16-G $\frac{1}{2}$ "MT		20	1 pièce
--	------------------------	--	----	---------

Uponor Smart Radi raccord à compression Oventrop

 1014016	16-G $\frac{1}{2}$ "MT		20	1 pièce
--	------------------------	--	----	---------

Uponor Smart Radi ens. connexion UNIFIX

 1011364			100	10 pièce
---	--	--	-----	----------

Uponor Smart Radi rosace divisible

 1011370	16 white		1350	50 pièce
--	----------	--	------	----------

Uponor Smart Radi rosace divisible

 1011373	14-20 white double		500	50 pièce
--	--------------------	--	-----	----------

Uponor RTM

N° art.	Dimension	UL	UE	unité
---------	-----------	----	----	-------

Uponor RTM coude PPSU

 1048547	16-16		40	1 pièce
1048548	20-20		25	1 pièce
1048549	25-25		15	1 pièce

Uponor RTM manchon PPSU

 1048542	16-16		40	1 pièce
1048543	20-20		30	1 pièce
1048544	25-25		20	1 pièce

Uponor RTM manchon réduit PPSU

 1048545	20-16		35	1 pièce
1048546	25-20		25	1 pièce

Uponor RTM té PPSU

 1048550	16-16-16		24	1 pièce
1048551	20-20-20		20	1 pièce
1048552	25-25-25		10	1 pièce

Uponor RTM té réduit PPSU

 1048553	20-16-20		20	1 pièce
1048554	20-16-16		20	1 pièce
1048555	20-20-16		20	1 pièce
1048556	25-20-25		14	1 pièce
1048557	25-20-20		14	1 pièce

Uponor RTM raccord mâle

 1048566	16-R $\frac{1}{2}$ "MT		48	1 pièce
1048567	20-R $\frac{1}{2}$ "MT		36	1 pièce
1048568	20-R $\frac{3}{4}$ "MT		25	1 pièce
1048569	25-R $\frac{3}{4}$ "MT		20	1 pièce
1048570	25-R1"MT		20	1 pièce

Uponor RTM raccord mâle BENELUX

 1062842	16-15mm		10	1 pièce
1062843	20-22mm		10	1 pièce
1062844	25-22mm		5	1 pièce

Uponor RTM raccord femelle

 1048581	16-Rp $\frac{1}{2}$ "FT		48	1 pièce
1048582	20-Rp $\frac{1}{2}$ "FT		36	1 pièce
1048583	20-Rp $\frac{3}{4}$ "FT		25	1 pièce
1048584	25-Rp $\frac{3}{4}$ "FT		25	1 pièce
1048585	25-Rp1"FT		20	1 pièce

N° art.	Dimension	UL	UE	unité
---------	-----------	----	----	-------

Uponor RTM adapt. coudé filetage ext.

 1048599	16-R $\frac{1}{2}$ "MT		30	1 pièce
1048600	20-R $\frac{1}{2}$ "MT		20	1 pièce
1048601	20-R $\frac{3}{4}$ "MT		20	1 pièce
1048602	25-R $\frac{3}{4}$ "MT		15	1 pièce

Uponor RTM adapt. coudé filetage int.

 1048590	16-Rp $\frac{1}{2}$ "FT		48	1 pièce
1048591	20-Rp $\frac{1}{2}$ "FT		30	1 pièce
1048592	20-Rp $\frac{3}{4}$ "FT		20	1 pièce
1048593	25-Rp $\frac{3}{4}$ "FT		20	1 pièce
1048594	25-Rp1"FT		20	1 pièce

Uponor RTM manchon réduit

 1048573	25-16		20	1 pièce
--	-------	--	----	---------

Uponor RTM té réduit

 1059011	16-20-16		20	1 pièce
--	----------	--	----	---------

Uponor RTM adapt. té filetage int.

 1048587	16-Rp $\frac{1}{2}$ "FT-16		30	1 pièce
1048588	20-Rp $\frac{1}{2}$ "FT-20		20	1 pièce
1048589	20-Rp $\frac{3}{4}$ "FT-20		20	1 pièce

Uponor RTM adapt. écrou tournant

 1057375	16- $\frac{1}{2}$ "SN		24	1 pièce
1057376	20- $\frac{3}{4}$ "SN		24	1 pièce

Uponor RTM adaptateur

 1048604	16-G $\frac{3}{4}$ "Euro		25	1 pièce
1048605	20-G $\frac{3}{4}$ "Euro		25	1 pièce

Uponor RTM adaptateur

 1048603	16-15CU		40	1 pièce
1057377	25-22CU		20	1 pièce

Uponor RTM bouchon à sertir

 1059013	16		48	1 pièce
--	----	--	----	---------

Uponor RTM

N° art.	Dimension	UL	UE	unité
---------	-----------	----	----	-------

Uponor Smart Aqua culasse en U RTM



1061621	16-Rp½"FT-16	20	5	pièce
----------------	--------------	----	---	-------

Uponor Smart Aqua culasse RTM



1048596	16-Rp½"FT	20	1	pièce
1048597	20-Rp½"FT	20	1	pièce
1048598	20-Rp¾"FT	20	1	pièce

Uponor Smart Aqua coude rés. ch. d'eau RTM Geberit



1057380	16-G½"FT	35	1	pièce
----------------	----------	----	---	-------

Uponor Smart Radi adaptateur coudé RTM



1057379	16-15CU l=200mm	15	1	pièce
----------------	-----------------	----	---	-------

N° art.	Dimension	UL	UE	unité
---------	-----------	----	----	-------

Uponor S-Press PLUS plaque de montage



1121197	80/150mm	5	1	pièce
----------------	----------	---	---	-------

Uponor S-Press PLUS étrier de montage



1121195	80/150mm	5	1	pièce
----------------	----------	---	---	-------

Uponor Smart Aqua étrier de montage Gemini



1059825	150mm	5	1	pièce
----------------	-------	---	---	-------

Uponor RS

Système de fixation modulaire pour canalisations répartitrices et ascendantes

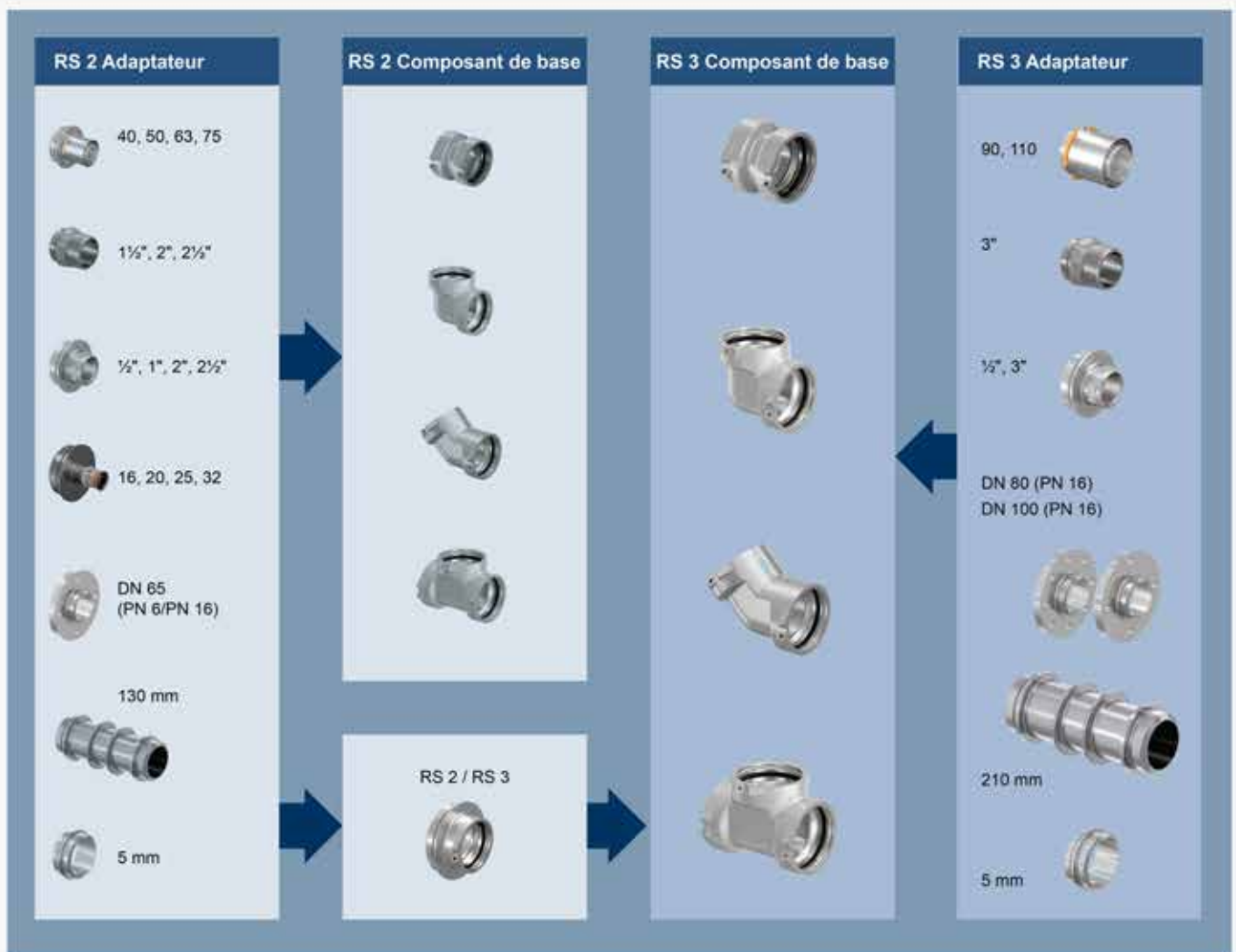



Uponor RS

N° art.	Dimension	UL	UE	unité
---------	-----------	----	----	-------

Uponor RS couplage

 1029144	RS2-RS2	480	1	pièce
 1029145	RS3-RS3	480	1	pièce



Uponor RS coude 90°

 1029138	RS2-RS2	336	1	pièce
 1029139	RS3-RS3	240	1	pièce

Uponor RS coude 45°

 1029140	RS2-RS2	336	1	pièce
 1029141	RS3-RS3	175	1	pièce



Uponor RS té égal

 1029142	RS2-RS2-RS2	336	1	pièce
 1029143	RS3-RS3-RS3	175	1	pièce



Uponor RS manchon réduit

 1029146	RS3-RS2	480	1	pièce
--	---------	-----	---	-------

Uponor RS manchon mâle-mâle

 1046750	RS2-RS2 l=5mm	480	1	pièce
 1046751	RS3-RS3 l=5mm	240	1	pièce



Uponor RS rallonge mâle

 1046477	RS2-RS2 l=130mm	240	1	pièce
 1046478	RS3-RS3 l=210mm	96	1	pièce







Uponor RS embout-réduction S-Press

 1059397	16-RS2	480	1	pièce
--	--------	-----	---	-------

Uponor RS adaptateur S-Press PLUS



 1095818	20-RS2	378	1	pièce
 1095819	25-RS2	378	1	pièce
 1095820	32-RS2	378	1	pièce

Uponor RS adaptateur S-Press







 1046940	40-RS2	480	1	pièce
 1046941	50-RS2	480	1	pièce
 1029125	63-RS2	400	1	pièce
 1029126	75-RS2	400	1	pièce
 1029127	90-RS3	240	1	pièce
 1029128	110-RS3	240	1	pièce

N° art.	Dimension	UL	UE	unité
---------	-----------	----	----	-------





Uponor RS raccord mâle

 1029131	R2 ^{MT} -RS2	480	1	pièce
 1029132	R2 1/2 ^{MT} -RS2	480	1	pièce
 1029133	R3 ^{MT} -RS3	240	1	pièce



Uponor RS raccord femelle

 1059403	Rp1/2 ^{FT} -RS2	480	1	pièce
 1029134	Rp1 ^{FT} -RS2	480	1	pièce
 1029135	Rp2 ^{FT} -RS2	480	1	pièce
 1029136	Rp2 1/2 ^{FT} -RS2	480	1	pièce
 1059404	Rp1/2 ^{FT} -RS3	336	1	pièce
 1029137	Rp3 ^{FT} -RS3	240	1	pièce

Uponor RS adaptateur à bride

 1059398	RS2-DN65 (PN6)	144	1	pièce
 1059399	RS2-DN65 (PN16)	90	1	pièce
 1029129	RS3-DN80 (PN16)	90	1	pièce
 1029130	RS3-DN100 (PN16)	90	1	pièce

Uponor RS tige de verrouillage

 1042921	RS2 black	5000	10	pièce
 1042922	RS3 black	-	10	pièce

Systemes Uponor pour chauffer et refroidir

	Type d'installation	Epaisseur de la plaque	Hauteur de montage minimale* mm	Nom du systeme	Description	Conduites associees	Dimension (mm)	
SOL	CONSTRUCTION HUMIDE	Pose de la plaque à plots, autocollante	—	15	Uponor Minitec	très faible hauteur de montage, directement sur le support existant (chape, tuiles, bois...)	Comfort Pipe	9,9
		Bandes d'accrochage	DES 25-2, 30-2, 30-3, 35-3 WLS032 25-2, DEO 15	74	Uponor Klett	Plaque et conduite avec microdenture. Mode de pose le plus rapide, aucun endommagement du film de chape	Klett Comfort Pipe PLUS Klett MLCP RED	14, 16 16
		Bandes accrochantes sur isolation existante	—	74	Uponor Klett Twinboard	Pose par bandes accrochantes sur isolation existante au moyen de dalles de plancher à compartiments creux 3 mm	Klett Comfort Pipe PLUS Klett MLCP RED	14, 16 16
		Bandes accrochantes y compris isolation laine minérale	30	74	Uponor Klett Silent	Pose par bandes accrochantes sur plaques en laine minérale, adjudications alternatives	Klett Comfort Pipe PLUS Klett MLCP RED	14, 16 16
		Dans le film à plots	—	30	Uponor Nubos	Choix libre de la couche d'isolation	Comfort Pipe PLUS Blue Comfort Pipe PLUS MLCP RED	16 16 14, 16
		Dans la plaque à plots	11 ou 30-2	82	Uponor Tecto	Montage rapide des conduites, plaques pour les plafonds de séparation entre étages, maintien sûr	Comfort Pipe PLUS Blue Comfort Pipe PLUS MLCP RED	16 14, 17 14, 16
		Dans la plaque à plots	11 ou 30-2	78	Uponor Nubos	Simple à utiliser, distances de montage conformément aux normes en vigueur	Comfort Pipe PLUS Blue Comfort Pipe PLUS MLCP RED	16 16 14, 16
		sur treillis soudés avec clip	—	83	Uponor Classic	Isolation acoustique optimale (isolation en laine minérale sur site). Séparation des métiers chape/ chauffage, grands circuits de chauffage	Comfort Pipe PLUS Blue Comfort Pipe PLUS Magna Pipe PLUS	16, 20 17 20
		Tacker et rail en U	EPS DEO 20, 30 DES 20-2, 25-2, 30-2, 30-3, 35-3, 40-3	75	Uponor Tacker	Solution la plus avantageuse. Différentes plaques à isolation thermique et contre les bruits d'impact disponibles	Comfort Pipe PLUS Blue Comfort Pipe PLUS MLCP RED	16 16, 17 14, 16
CONSTRUCTION A SEC	Dans des plaques EPS préformées et lamelles conductrices de chaleur en aluminium	25	50	Uponor Siccus 14	faible poids, immédiatement utilisable, capacité portante élevée	Comfort Pipe PLUS MLCP RED	14 14	
	Dans des plaques EPS préformées et lamelles conductrices de chaleur en aluminium	15	15	Uponor Siccus Mini		Comfort Pipe	9,9	

		Type d'installation	Epaisseur de la plaque	Hauteur de montage minimale* mm	Nom du système	Description	Conduites associées	Dimension (mm)
MURALE	HUMIDE	Sous l'enduit, avec rail de serrage	—	32	Uponor Fix	Pose efficace et sans torsion du grand rouleau avec un minimum de pertes	Comfort Pipe Comfort Pipe PLUS MLCP RED	9,9 14 14
	CONSTRUCTION A SEC	Dans des plaques EPS préformées	25	30	Uponor Siccus Wall	Ne nécessite aucun temps de séchage ; bref temps d'échauffement	Comfort Pipe PLUS MLCP RED	14 14
		Sur profilés CD 60/27, plaque de plâtre avec conduites de chauffage intégrées	—	15	Uponor Renovis	Plaque en plâtre renforcée de fibres de verre 15 mm, montage comme panneau à cloison sèche sur les surfaces murales	Comfort Pipe (intégré)	9,9
PLAFOND	HUMIDE	Sous l'enduit, avec rail de serrage	—	32	Uponor Fix	Pose efficace et sans torsion du grand rouleau avec un minimum de pertes	Comfort Pipe	9,9
	CONSTRUCTION A SEC	Sur profilés CD 60/27, plaque de plâtre avec conduites de chauffage intégrées	—	15	Uponor Renovis	Rendements de pose élevés sur profilés CD	Comfort Pipe (intégré)	9,9
		Sous-construction standard	—	15	Uponor Thermatop M	Revêtements de plafond sans joints ni orientation visible	Uni Pipe PLUS	16
AUTRES APPLICATIONS	HALLS	PLANCHERS CHAUFFANTS INDUSTRIELS						
		sur rail de serrage			Uponor Magna	Liberté absolue d'aménagement sans éléments optiques gênants	Comfort Pipe PLUS Blue Magna Pipe PLUS	20 20, 25
	TABULATIONS	ACTIVATION DU NOYAU DE BÉTON						
		Module préfabriqué sur tapis en acier (armature)			Uponor Contec	Pour installation dans le noyau de béton	Magna Pipe PLUS	20
		A proximité de la surface			Uponor Contec ON	Grille en nid d'abeilles avec conduites préparées pour un montage à proximité de la surface dans le coffrage en béton	Comfort Pipe PLUS	14
	CONSTRUCTION A SEC	REVÊTEMENTS SPORTIFS						
		Dans les halls de sports	30		Uponor Siccus Sport	pour les sols à élasticité surfacique avec construction en sandwich	Comfort Pipe PLUS MLC blanc	14 14
	Dans les halls de sports			Uponor Sport	Pour installation entre les dalles des sols de salles omnisports à élasticité surfacique	Magna Pipe PLUS	25	

Conduites Uponor pour le chauffage/refroidissement de surface

Type	Di- mension [mm]	Barrière de diffusion	Couleur de la conduite, Marquage	Pression [bar]	Tempé- rature [°C]	Lon- gueur [m]	N° art.	DIN-Certco N° certificat
Comfort Pipe PLUS 	14 x 2,0	PE-Xa avec barrière de diffusion à l'oxygène en EVOH	blanc, 2 bandes bleues	6	70	120	1062883	3V372
						240	1062884	
	16 x 2,0	PE-Xa avec barrière de diffusion à l'oxygène en EVOH	blanc, 2 bandes bleues	6	70	640	1088166	
						960	1062885	
17 x 2,0	PE-Xa avec barrière de diffusion à l'oxygène en EVOH	blanc, 2 bandes bleues	6	70	120	1062044	3V372	
					240	1062045		
20 x 2,0	PE-Xa avec barrière de diffusion à l'oxygène en EVOH	blanc, 2 bandes bleues	6	70	640	1062046		
					120	1034535		
20 x 2,0	PE-Xa avec barrière de diffusion à l'oxygène en EVOH	blanc, 2 bandes bleues	6	70	240	1009226	3V372	
					480	1086340		
20 x 2,0	PE-Xa avec barrière de diffusion à l'oxygène en EVOH	blanc, 2 bandes bleues	6	70	640	1009227		
					60	1009229		
Comfort Pipe PLUS Blue 	16 x 2,0	PE-Xa avec barrière de diffusion à l'oxygène en EVOH	blanc, 2 bandes bleues	6	70	640	1126541	3V372 ISCC- Certificatie
	20 x 2,0	PE-Xa avec barrière de diffusion à l'oxygène en EVOH	blanc, 2 bandes bleues	6	70	480	1126542	3V372 ISCC- Certificatie
Uponor Comfort Pipe PN10 	16 x 2,2	PE-Xa avec barrière de diffusion à l'oxygène en EVOH	nature	10	70	240	1119470	
						640	1119471	
20 x 2,8	PE-Xa avec barrière de diffusion à l'oxygène en EVOH	nature	10	70	240	1119472		
					640	1119533		
Klett Comfort Pipe PLUS 	14 x 2,0	PE-Xa avec barrière de diffusion à l'oxygène en EVOH	blanc, 2 bandes bleues, avec velcro	6	70	240	1088479	3V372
						640	1088480	
16 x 2,0	PE-Xa avec barrière de diffusion à l'oxygène en EVOH	blanc, 2 bandes bleues, avec velcro	6	70	240	1087302	3V372	
					640	1087303		
Magna Pipe PLUS 	20 x 2,0	PE-Xa avec barrière de diffusion à l'oxygène en EVOH	blanc, 2 bandes bleues	6	70	240	1091275	3V415
						480	1091276	
25 x 2,3	PE-Xa avec barrière de diffusion à l'oxygène en EVOH	blanc, 2 bandes bleues	6	70	300	1091277	3V415	
					640	1091278		
Minitec Comfort Pipe 	9,9 x 1,1	PE-Xa avec barrière de diffusion à l'oxygène en EVOH	nature, 1 bande bleue	6	70	60	1063287	3V279
						120	1063288	
						480	1063381	
MLC pipe wit 	14 x 2,0	Conduite composite avec AL	conduite blanche	10	80	200	1013366	
MLCP RED 	14 x 1,6	Conduite composite avec AL	conduite rouge	4	60	240	1096010	3V286
						480	1096011	
16 x 2,0	Conduite composite avec AL	conduite rouge	4	60	240	1096012	3V445	
					480	1096013		
MLCP RED Klett 	16 x 2,0	Conduite composite avec AL	conduite blanche, 2 bandes rouges, avec velcro	4	60	240	1096014	3V286
						480	1096015	

Technique de raccordement, raccords et outils

Raccordements vissés (par anneau de serrage)



Clé plate conventionnelle



Raccords Quick et Easy



Outils d'expansion Q+E



anneaux de retenue correspondants



rapex raccords à sertir



rapex mâchoires



Raccords à sertir Smart



Mâchoires MLC UPP1 et KSP0



Raccords S-Press et S-Press-PLUS



Vario/Fit 14x2,0	-	-	14	14	-
Vario/Fit 16x2,0	M12 & M18	nature eval et blanc	16	16	-
Vario/Fit 17x2,0	M12 & M18	nature eval et blanc	17	-	-
Vario/Fit 20x1,9/2,0	M12 & M18	nature eval et blanc	-	20	-
Vario/Fit 16x1,8/2,0	M12 & M18	nature eval et blanc	16	16	-
Vario/Fit 20x1,9/2,0	M12 & M18	nature eval et blanc	-	20	-
Flex-X 16x2,2	M12 & M18	blanc	-	-	-
Flex-X 20x2,8	M12 & M18	blanc	-	-	-
Vario/Fit 14x2,0	-	-	14	14	-
Vario/Fit 16x1,8/2,0	M12 & M18	natural eval & blanc	16	16	-
Vario/Fit 20x1,9/2,0	M12 & M18	natural eval & blanc	-	20	-
Vario/Fit 25x2,3	M12 & M18	natural eval & blanc	25	-	-
Vario & Minitec 9,9 x 1,1	Hand, M12 & M18	Minitec PEX	-	-	-
Uni-X 14-3/4 Euro	-	-	-	-	14
Vario MLCP RED 14x1,6 Euro	-	-	-	-	14 MLCP RED Press-Raccords
Uni-X 16-3/4 Euro	-	-	-	-	16
Uni-X 16-3/4 Euro	-	-	-	-	16

Uponor 10 bar UFH chauffage par le sol

N° art.	Dimension	UL	UE	unité
---------	-----------	----	----	-------

Uponor Comfort Pipe PN10

 1119470	16x2,2 240m	1440	240	m
1119471	16x2,2 640m	1280	640	m
1119472	20x2,8 240m	960	240	m
1119533	20x2,8 480m	960	480	m

Uponor Flex-X raccord à vis eurocône PEX

 1045542	16x2,2-3/4"FT Euro	100	10	jeu
1045543	20x2,8-3/4"FT Euro	100	10	jeu

Uponor Q&E manchon PPSU

 1008669	16-16	100	5	pièce
1008932	20-20	80	5	pièce

Uponor Q&E manchon PPSU

 1057453	16	900	20	pièce
1057454	20	520	20	pièce

N° art.	Dimension	UL	UE	unité
---------	-----------	----	----	-------

Uponor Q&E outil d'expansion avec tête M12

 1119379	16RS/20/25 10bar	-	1	jeu	1719,43
--	------------------	---	---	-----	---------

Uponor Q&E tête d'expansion M12/M18

 1119381	16x1,8/2,0/2,2	-	1	pièce	306,69
1119383	20x2,8	-	1	pièce	306,69

Uponor Minitec

N° art.	Dimension	UL	UE	unité
---------	-----------	----	----	-------

Uponor Minitec support adhésive Minitec

 1005261	15,4m ² 9,9x1,1 100x700x12mm123.2			15.4 m ²
--	--	--	--	---------------------

Uponor Fix Bornier

 1005274	9,9mm c/c20mm 2,5m		25	2.5 m
--	--------------------	--	----	-------

Uponor Minitec ruban périph., auto-adh.

 1005267	20m 80x8mm		-	200 m
--	------------	--	---	-------

Uponor Minitec profilé joint d'expansion

 1085980	0,9m 40x10mm		600	10 pièce
1085981	1,3m 40x10mm		600	10 pièce

Uponor Comfort Pipe tube Minitec

 1063287	9,9x1,1 60m		840	60 m
1063288	9,9x1,1 120m		1680	120 m
1063289	9,9x1,1 240m		2640	240 m
1063381	9,9x1,1 480m		2880	480 m

Uponor Minitec tube protection joint

 1005269	9,9mm 300x2mm		3600	30 pièce
--	---------------	--	------	----------

Uponor Minitec adaptateur pour collecteur

 1005266	9,9x1,1-G $\frac{3}{4}$ "Euro		100	10 pièce
--	-------------------------------	--	-----	----------

Uponor Minitec manchon avec bagues

 1005264	9,9x1,1		100	10 pièce
--	---------	--	-----	----------

Uponor Minitec raccord mâle

 1005265	9,9-R $\frac{1}{2}$ "MT		100	10 pièce
--	-------------------------	--	-----	----------

Uponor Minitec bague, coloris naturel

 1005263	9,9x1,1		1600	10 pièce
--	---------	--	------	----------

Uponor Minitec raccord à compression

 1013426	9,9- $\frac{3}{4}$ "Euro		120	12 pièce
--	--------------------------	--	-----	----------

Uponor Fluvia adaptateur à visser en Y

 1005675	2xG $\frac{3}{4}$ - $\frac{3}{4}$ "Euro		50	1 Kit
--	---	--	----	-------

Uponor Fluvia T groupe de pompe Push-12 AC-G

 1095128			60	1 pièce
--	--	--	----	---------

N° art.	Dimension	UL	UE	unité
---------	-----------	----	----	-------

Uponor Vario vanne remplissage/vidange

 1061802	$\frac{3}{4}$ " - $\frac{3}{4}$ "		10	1 Kit
--	-----------------------------------	--	----	-------

Uponor Multi coude de guidage de tuyau

 1135490	10-12		360	60 pièce
--	-------	--	-----	----------

Uponor Minitec boîte de connexion

 1005270	1x		30	1 pièce
1005271	2x		-	1 pièce
1005272	3x		-	1 pièce

La limitation de la température de conception doit être assurée par une pré-régulation.

Uponor Minitec couvercle boîte connexion

 1007251			-	1 pièce
--	--	--	---	---------

Uponor Base thermostat standard T-23 standard

 1058422	230V RAL9010		160	1 pièce
---	--------------	--	-----	---------

Uponor Minitec outil d'expansion

 1006247	9,9x1,1		11	1 Kit
--	---------	--	----	-------

Uponor Q&E outil d'évasement avec évasement c. M12/

 1119375	6bar 9,9RS/20		-	1 Kit
--	---------------	--	---	-------

Uponor Tecto

N° art.	Dimension	UL	UE	unité
---------	-----------	----	----	-------

Uponor Tecto plaque à plots

 1005478	EPS DES 30-2mm 14-17mm 1450x850mm	53.76	8.96	m ²
1005477	EPS 11mm 14-17mm 1450x850mm	94.08	15.68	m ²

Uponor Tecto fixation de tube diagonale

 1005482	45deg 75mm	420	10	pièce
--	------------	-----	----	-------

Uponor Tecto bande de jumelage, film

 1005484	1,4m 100mm	742.5	33.75	m
--	------------	-------	-------	---

Uponor Tecto élément d'expansion film

 1005481	1,45m 200mm	504	28	m
--	-------------	-----	----	---

Uponor Tecto élément d'expansion

 1005480	EPS DES 30-2mm 150x1400mm	268.8	8.4	m
1005479	EPS 11mm 150x1400mm	716.8	22.4	m

Uponor Multi bande périphérique

 1000079	150x8mm	-	200	m
--	---------	---	-----	---

Remarque : vente par unité d'emballage.

Uponor Multi ruban périph. bav. autocol.

 1000080	150x10mm	-	200	m
--	----------	---	-----	---

Remarque : vente par unité d'emballage.

Uponor Multi profilé pour joint PP

 1090229	1800x100x10mm	720	18	m
--	---------------	-----	----	---

Uponor Multi tube de protection de joint

 1000082	20mm 300x5mm	1800	30	pièce
--	--------------	------	----	-------

Uponor Comfort Pipe PLUS Blue tube

 1126541	16x2,0 640m	640	640	m
--	-------------	-----	-----	---

Uponor Comfort Pipe PLUS tube

 1062883	14x2,0 120m	1320	120	m
1062884	14x2,0 240m	1680	240	m
1088166	14x2,0 640m	1920	640	m
1062885	14x2,0 960m	1920	960	m
1062044	16x2,0 120m	1080	120	m
1062045	16x2,0 240m	1440	240	m
1062046	16x2,0 640m	1280	640	m
1034535	17x2,0 120m	840	120	m
1009226	17x2,0 240m	1200	240	m
1086340	17x2,0 480m	960	480	m
1009227	17x2,0 640m	1280	640	m

N° art.	Dimension	UL	UE	unité
---------	-----------	----	----	-------

Uponor Vario raccord de compression PEX

 1065283	14x2,0-G ³ / ₄ "FT Euro	25	1	pièce
1065284	16x1,8/2,0-G ³ / ₄ "FT Euro	25	1	pièce
1065286	17x2,0-G ³ / ₄ "FT Euro	25	1	pièce

Uponor Fit couplage de compression PEX

 1065296	16x1,8/2,0-16x1,8/2,0	25	1	pièce
1065299	17x2,0-17x2,0	25	1	pièce

Uponor Rapex manchon

 1005079	17-17	100	10	pièce
--	-------	-----	----	-------

Uponor Smart manchon égal à sertir

 1089646	14x2,0-14x2,0	80	20	pièce
1089647	16x1,8/2,0-16x1,8/2,0	80	20	pièce

Uponor MLCP RED tube

 1096010	14x1,6 240m	3120	240	m
1096011	14x1,6 480m	3360	480	m
1096012	16x2,0 240m	3120	240	m
1096013	16x2,0 480m	3360	480	m

Uponor Vario adaptateur à visser MLCP Red

 1000117	14x1,6- ³ / ₄ "Euro	80	20	pièce
---	---	----	----	-------

Uponor MLCP Red raccord à sertir

 1048272	14x1,6-14x1,6	80	20	pièce
--	---------------	----	----	-------

Uponor S-Press PLUS manchon à sertir

 1070547	16-16	80	20	pièce
--	-------	----	----	-------

Uponor S-Press PLUS manchon à sertir PPSU

 1039933	16-16	80	20	pièce
--	-------	----	----	-------

Uponor Uni-X raccord à compression MLC

 1058090	16- ³ / ₄ "FT Euro	25	1	pièce
---	--	----	---	-------

Uponor Multi coude de guidage de tuyau

 1135491	14-18	240	30	pièce
--	-------	-----	----	-------

Uponor Nubos

N° art.	Dimension	UL	UE	unité
---------	-----------	----	----	-------

Uponor Nubos plaque

 1016699	EPS DES 30-2 14-16mm 1447x900x48mm	10	1	m ²
1016700	EPS 11 14-16mm 1447x900x29mm	100	10	m ²

Uponor Nubos film

 1016703	14-16mm		140	10 m ²
--	---------	--	-----	-------------------

Uponor Nubos film unpacked

 1061880	14-16mm	-		200 m ²
--	---------	---	--	--------------------

Uponor Nubos ensemble

 1016701	EPS 30-2 14-16mm 1447x900x48mm	50	5	m ²
 1016702	EPS 11 14-16mm 1447x900x29mm	50	5	m ²

Uponor Multi bande périphérique

 1000079	150x8mm	-		200 m
--	---------	---	--	-------

Remarque : vente par unité d'emballage.

Uponor Multi ruban périph. bav. autocol.

 1000080	150x10mm	-		200 m
--	----------	---	--	-------

Remarque : vente par unité d'emballage.

Uponor Multi profilé pour joint PP

 1090229	1800x100x10mm	720	18	m
--	---------------	-----	----	---

Uponor Multi tube de protection de joint

 1000082	20mm 300x5mm	1800	30	pièce
--	--------------	------	----	-------

Uponor Fix barre de serrage avec bande adhésive

 1135496	16-20mm c/c 50mm 1m	2000	100	pièce
--	---------------------	------	-----	-------

Uponor Comfort Pipe PLUS Blue tube

 1126541	16x2,0 640m	640	640	m
--	-------------	-----	-----	---

Uponor Comfort Pipe PLUS tube

 1062883	14x2,0 120m	1320	120	m
1062884	14x2,0 240m	1680	240	m
1088166	14x2,0 640m	1920	640	m
1062885	14x2,0 960m	1920	960	m
1062044	16x2,0 120m	1080	120	m
1062045	16x2,0 240m	1440	240	m
1062046	16x2,0 640m	1280	640	m

Uponor Vario raccord de compression PEX

 1065283	14x2,0-G ³ / ₄ "FT Euro	25	1	pièce
 1065284	16x1,8/2,0-G ³ / ₄ "FT Euro	25	1	pièce

N° art.	Dimension	UL	UE	unité
---------	-----------	----	----	-------

Uponor Fit couplage de compression PEX

 1065296	16x1,8/2,0-16x1,8/2,0	25	1	pièce
--	-----------------------	----	---	-------

Uponor Smart manchon égal à sertir

 1089646	14x2,0-14x2,0	80	20	pièce
1089647	16x1,8/2,0-16x1,8/2,0	80	20	pièce

Uponor MLCP RED tube

 1096010	14x1,6 240m	3120	240	m
1096011	14x1,6 480m	3360	480	m
1096012	16x2,0 240m	3120	240	m
1096013	16x2,0 480m	3360	480	m

Uponor Vario adaptateur à visser MLCP Red

 1000117	14x1,6- ³ / ₄ "Euro	80	20	pièce
--	---	----	----	-------

Uponor MLCP Red raccord à sertir

 1048272	14x1,6-14x1,6	80	20	pièce
--	---------------	----	----	-------

Uponor Uni-X raccord à compression MLC

 1058090	16- ³ / ₄ "FT Euro	25	1	pièce
---	--	----	---	-------

Uponor Multi coude de guidage de tuyau

 1135491	14-18	240	30	pièce
--	-------	-----	----	-------

Uponor Klett

N° art.	Dimension	UL	UE	unité
---------	-----------	----	----	-------

Uponor Klett plaque en rouleau extra

 1063402	EPS DES 25-2mm 10x1m	80	10	m ²
1063322	EPS DES 30-2mm 10x1m	80	10	m ²
1063323	EPS DES 30-3mm 10x1m	80	10	m ²
1063324	EPS DES 35-3mm 10x1m	70	10	m ²

Uponor Klett Twinboard - double panneau

 1086854	2400x1000x3mm	360	24	m ²
--	---------------	-----	----	----------------

Uponor Klett panneau Silent

 1088065	1200x1000x30mm	48	4.8	m ²
--	----------------	----	-----	----------------

Uponor Multi bande périphérique

 1000079	150x8mm	-	200	m
--	---------	---	-----	---

Remarque : vente par unité d'emballage.

Uponor Multi ruban périph. bav. autocol.

 1000080	150x10mm	-	200	m
--	----------	---	-----	---

Remarque : vente par unité d'emballage.

Uponor Klett ruban périphérique

 1089919	1200x120x13mm	1536	96	m
--	---------------	------	----	---

Uponor Klett film d'étanchéité, autoadh.

 1089951	50m 280x0,2mm	6000	50	m
--	---------------	------	----	---

Uponor Multi profilé pour joint PP

 1090229	1800x100x10mm	720	18	m
--	---------------	-----	----	---

Uponor Multi tube de protection de joint

 1000082	20mm 300x5mm	1800	30	pièce
--	--------------	------	----	-------

N° art.	Dimension	UL	UE	unité
---------	-----------	----	----	-------

Uponor Klett tube

 1088479	14x2,0 240m	1440	240	m
1088480	14x2,0 640m	1280	640	m
1087302	16x2,0 240m	1200	240	m
1087303	16x2,0 640m	1280	640	m

Uponor Vario raccord de compression PEX

 1065283	14x2,0-G $\frac{3}{4}$ "FT Euro	25	1	pièce
1065284	16x1,8/2,0-G $\frac{3}{4}$ "FT Euro	25	1	pièce

Uponor Smart manchon égal à sertir

 1089646	14x2,0-14x2,0	80	20	pièce
1089647	16x1,8/2,0-16x1,8/2,0	80	20	pièce

Uponor Fit couplage de compression PEX

 1065296	16x1,8/2,0-16x1,8/2,0	25	1	pièce
--	-----------------------	----	---	-------

Uponor Klett MLCP tube rouge

 1096014	16x2,0 240m	1920	240	m
1096015	16x2,0 480m	2400	480	m

Uponor Uni-X raccord à compression MLC

 1058090	16- $\frac{3}{4}$ "FT Euro	25	1	pièce
--	----------------------------	----	---	-------

Uponor Multi rouleau de ruban adhésif

 1000012	66m 50mm	36	1	pièce
--	----------	----	---	-------

Uponor Multi coude de guidage de tuyau

 1135491	14-18	240	30	pièce
--	-------	-----	----	-------

Uponor Multi support de tube

 1088066		-	1	pièce
--	--	---	---	-------

Uponor Tacker

N° art.	Dimension	UL	UE	unité
---------	-----------	----	----	-------

Uponor Tacker rouleau

 1090921	EPS DES 20-2mm 10x1m	100	10	m ²
1090924	EPS DES 30-2mm 10x1m	80	10	m ²
1090925	EPS DES 30-3mm 10x1m	80	10	m ²
1090926	EPS DES 35-3mm 10x1m	70	10	m ²
1090927	EPS DES 40-3mm 10x1m	60	10	m ²

Uponor Tacker panneau

 1090917	EPS DEO 20	100	10	m ²
1090918	EPS DEO 30	80	10	m ²

Uponor Tacker Film transparent

 1122372	0,2mm 100x1,03m	2884	103	m ²
--	-----------------	------	-----	----------------

Uponor Multi bande périphérique

 1000079	150x8mm	-	200	m
--	---------	---	-----	---

Remarque : vente par unité d'emballage.

Uponor Multi ruban périph. bav. autocol.

 1000080	150x10mm	-	200	m
---	----------	---	-----	---

Remarque : vente par unité d'emballage.

Uponor Multi profilé pour joint PP

 1090229	1800x100x10mm	720	18	m
--	---------------	-----	----	---

Uponor Multi tube de protection de joint

 1000082	20mm 300x5mm	1800	30	pièce
--	--------------	------	----	-------

Uponor Fix clou pour rail de fixation

 1086533		5000	500	pièce
--	--	------	-----	-------

N° art.	Dimension	UL	UE	unité
---------	-----------	----	----	-------

Uponor Comfort Pipe PLUS Blue tube

 1126541	16x2,0 640m	640	640	m
1126542	20x2,0 480m	480	480	m

Uponor Comfort Pipe PLUS tube

 1062883	14x2,0 120m	1320	120	m
1062884	14x2,0 240m	1680	240	m
1062885	14x2,0 960m	1920	960	m
1062044	16x2,0 120m	1080	120	m
1062045	16x2,0 240m	1440	240	m
1062046	16x2,0 640m	1280	640	m
1034535	17x2,0 120m	840	120	m
1009226	17x2,0 240m	1200	240	m
1009227	17x2,0 640m	1280	640	m

Uponor Magna

 1091275	20x2,0 240m	960	240	m
1091276	20x2,0 480m	960	480	m

Uponor Vario raccord de compression PEX

 1065283	14x2,0-G ³ / ₄ "FT Euro	25	1	pièce
1065284	16x1,8/2,0-G ³ / ₄ "FT Euro	25	1	pièce
1065286	17x2,0-G ³ / ₄ "FT Euro	25	1	pièce
1065290	20x1,9/2,0-G ³ / ₄ "FT Euro	25	1	pièce

Uponor Fit couplage de compression PEX

 1065296	16x1,8/2,0-16x1,8/2,0	25	1	pièce
1065299	17x2,0-17x2,0	25	1	pièce
1065302	20x1,9/2,0-20x1,9/2,0	25	1	pièce

Uponor Smart manchon égal à sertir

 1089646	14x2,0-14x2,0	80	20	pièce
1089647	16x1,8/2,0-16x1,8/2,0	80	20	pièce

Uponor Rapex manchon

 105079	17-17	100	10	pièce
---	-------	-----	----	-------

Uponor Tacker

N° art.	Dimension	UL	UE	unité
---------	-----------	----	----	-------

Uponor MLCP RED tube

 1096010	14x1,6 240m		3120	240 m
1096011	14x1,6 480m		3360	480 m
1096012	16x2,0 240m		3120	240 m
1096013	16x2,0 480m		3360	480 m

Uponor Vario adaptateur à visser MLCP Red

 1000117	14x1,6-3/4" Euro		80	20 pièce
--	------------------	--	----	----------

Uponor MLCP Red raccord à sertir

 1048272	14x1,6-14x1,6		80	20 pièce
--	---------------	--	----	----------

Uponor Uni-X raccord à compression MLC

 1058090	16-3/4" FT Euro		25	1 pièce
--	-----------------	--	----	---------

N° art.	Dimension	UL	UE	unité
---------	-----------	----	----	-------

Uponor S-Press PLUS manchon à sertir

 1070547	16-16		80	20 pièce
--	-------	--	----	----------

Uponor S-Press PLUS manchon à sertir PPSU

 1039933	16-16		80	20 pièce
--	-------	--	----	----------

Uponor Tacker agrafe stan. tube Tacker set = 1000pce

 NEW 1140159	14-20mm h=40mm	8	1	Kit
---	----------------	---	---	-----

Uponor Tacker agrafeuse longue set = 250pce

 NEW 1140124	14-20mm h=50mm	20	1	Kit
---	----------------	----	---	-----

Uponor Tacker outil

 NEW 1119039	14-20mm	50	1	pièce
--	---------	----	---	-------

Uponor Fix barre de serrage avec bande adhésive

 1135496	16-20mm c/c 50mm 1m	2000	100	pièce
--	---------------------	------	-----	-------

Uponor Multi coude de guidage de tuyau

 1135491	14-18	240	30	pièce
1135492	20-22	140	35	pièce

Uponor Classic

N° art.	Dimension	UL	UE	unité
---------	-----------	----	----	-------

Uponor Classic treillis enrobé

 1005084	100mm 2100x1200x3mm	25.2	1	m ²
1005087	150mm 2100x1200x3mm	756	25.2	m ²

Uponor Classic fil lien, acier, revêtu

 1007393	80mm (100pce/set)	2500	50	Kit
--	-------------------	------	----	-----

Uponor Classic support de tube pour treillis métallique

 1005188	16mm 3mm	5000	500	pièce
1005189	17mm 3mm	5000	500	pièce
1005190	20mm 3mm	2800	280	pièce

Uponor Multi bande périphérique

 1000079	150x8mm	-	200	m
--	---------	---	-----	---

Remarque : vente par unité d'emballage.

Uponor Multi ruban périph. bav. autocol.

 1000080	150x10mm	-	200	m
--	----------	---	-----	---

Remarque : vente par unité d'emballage.

Uponor Multi profilé pour joint PP

 1090229	1800x100x10mm	720	18	m
--	---------------	-----	----	---

Uponor Multi tube de protection de joint

 1000082	20mm 300x5mm	1800	30	pièce
--	--------------	------	----	-------

Uponor Comfort Pipe PLUS Blue tube

 1126541	16x2,0 640m	640	640	m
1126542	20x2,0 480m	480	480	m

Uponor Comfort Pipe PLUS tube

 1062044	16x2,0 120m	1080	120	m
1062045	16x2,0 240m	1440	240	m
1062046	16x2,0 640m	1280	640	m
1034535	17x2,0 120m	840	120	m
1009226	17x2,0 240m	1200	240	m
1086340	17x2,0 480m	960	480	m
1009227	17x2,0 640m	1280	640	m

Uponor Magna

 1091275	20x2,0 240m	960	240	m
1091276	20x2,0 480m	960	480	m

Uponor Vario raccord de compression PEX

 1065284	16x1,8/2,0-G ³ / ₄ "FT Euro	25	1	pièce
1065286	17x2,0-G ³ / ₄ "FT Euro	25	1	pièce
1065290	20x1,9/2,0-G ³ / ₄ "FT Euro	25	1	pièce

N° art.	Dimension	UL	UE	unité
---------	-----------	----	----	-------

Uponor Fit couplage de compression PEX

 1065296	16x1,8/2,0-16x1,8/2,0	25	1	pièce
1065299	17x2,0-17x2,0	25	1	pièce
1065302	20x1,9/2,0-20x1,9/2,0	25	1	pièce

Uponor Smart manchon égal à sertir

 1089647	16x1,8/2,0-16x1,8/2,0	80	20	pièce
1089648	20x2,0-20x2,0	80	20	pièce

Uponor Rapex manchon

 1005079	17-17	100	10	pièce
--	-------	-----	----	-------

Uponor Multi coude de guidage de tuyau

 1135491	14-18	240	30	pièce
1135492	20-22	140	35	pièce

Uponor Classic

 1006295	16/17mm l=920mm	100	1	pièce
1006309	20mm l=920mm	-	1	pièce

Uponor Classic outil tordage

 1006243	l=320mm	50	1	pièce
--	---------	----	---	-------

NEW Uponor Siccus Mini

N° art.	Dimension	UL	UE	unité
---------	-----------	----	----	-------

Uponor Siccus Mini panneau

 NEW 1122381	1200x600x15mm	144	7.2	m ²
--	---------------	-----	-----	----------------

Uponor Siccus Mini panneau support de carrelage

 NEW 1139793	1000x600x6mm	90	3	m ²
--	--------------	----	---	----------------

Uponor Siccus Mini renforcement des bords

 NEW 1139794	1000x45x15mm	800	10	m
--	--------------	-----	----	---

Uponor Siccus Mini bande de renforcement des joints

 NEW 1139795	143mm 12m	3360	24	m
--	-----------	------	----	---

Uponor Minitec ruban périph., auto-adh.

 1005267	20m 80x8mm	-	200	m
---	------------	---	-----	---

Uponor Minitec profilé joint d'expansion

 1085980	0,9m 40x10mm	600	10	pièce
1085981	1,3m 40x10mm	600	10	pièce

N° art.	Dimension	UL	UE	unité
---------	-----------	----	----	-------

Uponor Comfort Pipe tube Minitec

 1063288	9,9x1,1 120m	1680	120	m
1063289	9,9x1,1 240m	2640	240	m
1063381	9,9x1,1 480m	2880	480	m

Uponor Minitec adaptateur pour collecteur

 1005266	9,9x1,1-G ³ / ₄ "Euro	100	10	pièce
---	---	-----	----	-------

Uponor Minitec manchon avec bagues

 1005264	9,9x1,1	100	10	pièce
---	---------	-----	----	-------

Uponor Minitec raccord mâle

 1005265	9,9-R ¹ / ₂ "MT	100	10	pièce
---	---------------------------------------	-----	----	-------

Uponor Minitec bague, coloris naturel

 1005263	9,9x1,1	1600	10	pièce
---	---------	------	----	-------

Uponor Minitec raccord à compression

 1013426	9,9- ³ / ₄ "Euro	120	12	pièce
---	--	-----	----	-------

Uponor Minitec

 1016690	9,9-9,9	48	12	pièce
---	---------	----	----	-------

Uponor Fluvia adaptateur à visser en Y

 1005675	2xG ³ / ₄ - ³ / ₄ "Euro	50	1	Kit
---	---	----	---	-----

Uponor Siccus Mini

N° art.	Dimension	UL	UE	unité
---------	-----------	----	----	-------

Uponor Fluvia T groupe de pompage Push-12 TH-G

 1095127		60	1	pièce
--	--	----	---	-------

Uponor Fluvia T groupe pompe Push-12 CH-G

 1095131		30	1	pièce
--	--	----	---	-------

Uponor Fluvia T groupe de pompe Push-12 AC-G

 1095128		60	1	pièce
--	--	----	---	-------

Uponor Vario vanne remplissage/vidange

 1061802	3/4" - 3/4"	10	1	Kit
--	-------------	----	---	-----

Uponor Multi coude de guidage de tuyau

 1135490	10-12	360	60	pièce
--	-------	-----	----	-------

N° art.	Dimension	UL	UE	unité
---------	-----------	----	----	-------

Uponor Minitec boîte de connexion

 1005270	1x		30	1 pièce
1005271	2x		-	1 pièce
1005272	3x		-	1 pièce

La limitation de la température de conception doit être assurée par une pré-régulation.



Uponor Minitec couvercle boîte connexion

 1007251			-	1 pièce
--	--	--	---	---------

Uponor Base thermostat standard T-23 standard



 1058422	230V RAL9010		160	1 pièce
--	--------------	--	-----	---------

Uponor Vario PLUS moteur NC

 1000138	24V MT30x1,5		10	1 pièce
 1005605	230V MT30x1,5		10	1 pièce

Livraison dans la limite des stocks disponibles. L'article expire au cours de l'année.

Uponor Vario PLUS moteur NC

 1141678	MT 230V 1W IP54		100	1 pièce
 1141679	MT 24V 1W IP54		100	1 pièce

Uponor Vario Kit adaptateur

 1141758	M, MAGNA, PLUS, S		50	1 Kit
--	-------------------	--	----	-------

Uponor Minitec outil d'expansion

 1006247	9,9x1,1		11	1 Kit
--	---------	--	----	-------

Uponor Q&E outil d'évasement avec évasement c. M12/

 1119375	6bar 9,9RS/20		-	1 Kit
--	---------------	--	---	-------

Uponor Siccus Mini appareil de découpe à chaud

 1139796	10mm 230V		20	1 pièce
--	-----------	--	----	---------

Uponor Siccus 14

N° art.	Dimension	UL	UE	unité
---------	-----------	----	----	-------

Uponor Siccus 14 panneau

 1005485	EPS 150kPa 14mm 1197x1050x25mm		100	12.5 m²
--	-----------------------------------	--	-----	---------

Uponor Siccus 14 lamelle thermo-conduct.

 1005486	14mm 1180x120x0,45mm		768	48 pièce
--	----------------------	--	-----	----------

Uponor Comfort Pipe PLUS tube

 1062883	14x2,0 120m		1320	120 m
1062884	14x2,0 240m		1680	240 m
1088166	14x2,0 640m		1920	640 m
1062885	14x2,0 960m		1920	960 m

Uponor Vario raccord de compression PEX

 1065283	14x2,0-G¾"FT Euro		25	1 pièce
--	-------------------	--	----	---------

Uponor Smart manchon égal à sertir

 1089646	14x2,0-14x2,0		80	20 pièce
---	---------------	--	----	----------

N° art.	Dimension	UL	UE	unité
---------	-----------	----	----	-------

Uponor MLCP RED tube

 1096010	14x1,6 240m		3120	240 m
1096011	14x1,6 480m		3360	480 m

Uponor Vario adaptateur à visser MLCP Red

 1000117	14x1,6-¾" Euro		80	20 pièce
--	----------------	--	----	----------

Uponor MLCP Red raccord à sertir

 1048272	14x1,6-14x1,6		80	20 pièce
--	---------------	--	----	----------

Uponor Multi bande périphérique

 1000079	150x8mm		-	200 m
--	---------	--	---	-------

Remarque : vente par unité d'emballage.

Uponor Multi coude de guidage de tuyau

 1135491	14-18		240	30 pièce
--	-------	--	-----	----------

Uponor Siccus 14 cutter à polystyrène

 1006290	14mm 230V		-	1 pièce
--	-----------	--	---	---------

Uponor Renovis

N° art.	Dimension	UL	UE	unité
---------	-----------	----	----	-------

Uponor Renovis panneau

 1061173	800x625mm		24	1 pièce
1061172	1200x625mm		24	1 pièce
1061171	2000x625mm		24	1 pièce

Uponor Renovis panneau extra

 1063923	800x625x15mm		24	1 pièce
1063924	1200x625x15mm		24	1 pièce
1063925	2000x625x15mm		24	1 pièce

Uponor Renovis panneau passif

 1063926	2000x625x15mm	-	24	pièce
--	---------------	---	----	-------

Uponor Renovis kit de composants

 1061165	4-6x		10	1 Kit
--	------	--	----	-------

Uponor Fix bornier

 1005274	9,9mm c/c20mm 2,5m		25	2.5 m
--	--------------------	--	----	-------

Uponor Renovis rail de fixation

 1061162	20mm l=250mm	-	15	pièce
--	--------------	---	----	-------

Uponor Comfort Pipe tube Minitec

 1063287	9,9x1,1 60m		840	60 m
1063288	9,9x1,1 120m		1680	120 m

Uponor Minitec raccord mâle

 1005265	9,9-R $\frac{1}{2}$ MT		100	10 pièce
--	------------------------	--	-----	----------

Uponor Minitec manchon avec bagues

 1005264	9,9x1,1		100	10 pièce
--	---------	--	-----	----------

Uponor Minitec bague, coloris naturel

 1005263	9,9x1,1		1600	10 pièce
--	---------	--	------	----------

Uponor Comfort Pipe PLUS tube

 1009229	20x2,0 60m		660	60 m
--	------------	--	-----	------

Uponor Magna

 1091275	20x2,0 240m		960	240 m
1091276	20x2,0 480m		960	480 m

Uponor Q&E té réduit, bague Minitec

 1020524	20xMinitec9,9xQ&E20		75	5 pièce
--	---------------------	--	----	---------

Uponor Q&E manchon réduit Minitec

 1020518	20xMinitec9,9		150	5 pièce
--	---------------	--	-----	---------

N° art.	Dimension	UL	UE	unité
---------	-----------	----	----	-------

Uponor Q&E manchon PPSU

 1008932	20-20		80	5 pièce
--	-------	--	----	---------

Uponor Q&E coude PPSU

 1008680	20-20		40	5 pièce
--	-------	--	----	---------

Uponor Q&E bague évolution white

 1057454	20		520	20 pièce
--	----	--	-----	----------

Uponor Uni Pipe PLUS blanc S

 1060784	20x2,25 3m		51	3 m
--	------------	--	----	-----

Uponor Q&E adaptateur en T S-Press

 1063938	20-Q&E9,9-Press20		6	2 pièce
--	-------------------	--	---	---------

Uponor Q&E adaptateur S-Press

 1063939	20-Q&E9,9		12	2 pièce
--	-----------	--	----	---------

Uponor Vario vanne de réglage fin

 1005107	$\frac{1}{2}$ " - G $\frac{3}{4}$		50	1 pièce
--	-----------------------------------	--	----	---------

Uponor Vario vanne de fermeture retour

 1005108	$\frac{1}{2}$ " - G $\frac{3}{4}$		50	1 pièce
--	-----------------------------------	--	----	---------

Uponor Vario PLUS actionneur thermique NC

 1005605	230V MT30x1,5		10	1 pièce
Livraison dans la limite des stocks disponibles. L'article expire au cours de l'année.				

Uponor Vario PLUS moteur NC

 1141678	MT 230V 1W IP54		100	1 pièce
--	-----------------	--	-----	---------

Uponor Base thermostat standard T-23 standard

 1058422	230V RAL9010		160	1 pièce
--	--------------	--	-----	---------

Uponor Minitec outil d'expansion

 1006247	9,9x1,1		11	1 Kit
--	---------	--	----	-------

Uponor Multi coude de guidage de tuyau

 1135490	10-12		360	60 pièce
1135491	14-18		240	30 pièce

Uponor Teporis

N° art.	Dimension	UL	UE	unité
---------	-----------	----	----	-------

Uponor Teporis plaque avec EPS actif

 1047319	2000x1200mm		25	1 pièce
1047320	1000x1200mm		50	1 pièce
1047321	500x1200mm		100	1 pièce

Uponor Teporis plaque avec EPS passif

 1020506	2000x1200mm		-	25 pièce
--	-------------	--	---	----------

Uponor Comfort Pipe tube Minitec

 1063287	9,9x1,1 60m		840	60 m
1063288	9,9x1,1 120m		1680	120 m

Uponor Minitec manchon avec bagues

 1005264	9,9x1,1		100	10 pièce
--	---------	--	-----	----------

Uponor Minitec bague, coloris naturel

 1005263	9,9x1,1		1600	10 pièce
--	---------	--	------	----------

Uponor Minitec raccord mâle

 1005265	9,9-R½"MT		100	10 pièce
---	-----------	--	-----	----------

N° art.	Dimension	UL	UE	unité
---------	-----------	----	----	-------

Uponor Comfort Pipe PLUS tube

 1009229	20x2,0 60m		660	60 m
--	------------	--	-----	------

Uponor Magna

 1091275	20x2,0 240m		960	240 m
1091276	20x2,0 480m		960	480 m

Uponor Q&E té réduit, bague Minitec

 1020524	20xMinitec9,9xQ&E20		75	5 pièce
--	---------------------	--	----	---------

Uponor Q&E manchon réduit Minitec

 1020518	20xMinitec9,9		150	5 pièce
--	---------------	--	-----	---------

Uponor Q&E bague évolution white

 1057454	20		520	20 pièce
1057455	25		300	20 pièce

Uponor Vario raccord de compression PEX

 1065290	20x1,9/2,0-G¾"FT Euro		25	1 pièce
--	-----------------------	--	----	---------

Uponor Fix bornier

 1005274	9,9mm c/c20mm 2,5m		25	2.5 m
--	--------------------	--	----	-------

Uponor Multi coude de guidage de tuyau

 1135490	10-12		360	60 pièce
--	-------	--	-----	----------

Uponor Minitec outil d'expansion

 1006247	9,9x1,1		11	1 Kit
--	---------	--	----	-------

Uponor Thermanatop

N° art.	Dimension	UL	UE	unité
---------	-----------	----	----	-------

Uponor Thermanatop M

 1090933	950x277mm	200	10	pièce
1090934	1350X277mm	200	10	pièce
1090935	1750X277mm	200	10	pièce
1090936	2150X277mm	200	10	pièce
1090937	2550x277mm	200	10	pièce

N° art.	Dimension	UL	UE	unité
---------	-----------	----	----	-------

Uponor Uni-X adaptateur à visser MLC

 1058090	16-3/4"FT Euro	25	1	pièce
--	----------------	----	---	-------

Uponor S-Press PLUS manchon à sertir

 1070547	16-16	80	10	pièce
--	-------	----	----	-------

Uponor S-Press PLUS manchon à sertir PPSU

 1039933	16-16	80	10	pièce
--	-------	----	----	-------



Uponor Siccus Wall

N° art.	Dimension	UL	UE	unité
---------	-----------	----	----	-------

Uponor Siccus 14 panneau

 1005485	EPS 150kPa 14mm 1197x1050x25mm		100	12.5 m ²
--	-----------------------------------	--	-----	---------------------

Uponor Siccus 14 lamelle thermo-conduct.

 1005486	14mm 1180x120x0,45mm		768	48 pièce
--	----------------------	--	-----	----------

Uponor Comfort Pipe PLUS tube

 1062883	14x2,0 120m		1320	120 m
1062884	14x2,0 240m		1680	240 m
1062885	14x2,0 960m		1920	960 m

Uponor Vario raccord de compression PEX

 1065283	14x2,0-G ³ / ₄ "FT Euro		25	1 pièce
--	---	--	----	---------

Uponor Smart manchon égal à sertir

 1089646	14x2,0-14x2,0		80	20 pièce
--	---------------	--	----	----------

N° art.	Dimension	UL	UE	unité
---------	-----------	----	----	-------

Uponor MLCP RED tube

 1096010	14x1,6 240m		3120	240 m
1096011	14x1,6 480m		3360	480 m

Uponor Vario adaptateur à visser MLCP Red

 1000117	14x1,6- ³ / ₄ "Euro		80	20 pièce
--	---	--	----	----------

Uponor MLCP Red raccord à sertir

 1048272	14x1,6-14x1,6		80	20 pièce
--	---------------	--	----	----------

Uponor Siccus 14 cutter à polystyrène

 1006290	14mm 230V		-	1 pièce
--	-----------	--	---	---------

Uponor Fix

N° art.	Dimension	UL	UE	unité
---------	-----------	----	----	-------

Uponor Fix barre de serrage avec bande adhésive

 1135496	16-20mm c/c 50mm 1m		2000	100 pièce
--	---------------------	--	------	-----------

Uponor Fix bornier

 1005498	14mm c/c50mm 2,5m	-		25 m
--	-------------------	---	--	------

Uponor Fix bornier

 1005274	9,9mm c/c20mm 2,5m		25	2.5 m
--	--------------------	--	----	-------

Uponor Comfort Pipe PLUS tube

 1062883	14x2,0 120m		1320	120 m
--	-------------	--	------	-------

1062884	14x2,0 240m		1680	240 m
----------------	-------------	--	------	-------

1062885	14x2,0 960m		1920	960 m
----------------	-------------	--	------	-------

1009229	20x2,0 60m		660	60 m
----------------	------------	--	-----	------

Uponor Comfort Pipe tube Minitec

 1063287	9,9x1,1 60m		840	60 m
--	-------------	--	-----	------

1063288	9,9x1,1 120m		1680	120 m
----------------	--------------	--	------	-------

1063381	9,9x1,1 480m		2880	480 m
----------------	--------------	--	------	-------

Uponor Magna

 1091275	20x2,0 240m		960	240 m
--	-------------	--	-----	-------

Uponor Vario raccord de compression PEX

 1065283	14x2,0-G $\frac{3}{4}$ "FT Euro		25	1 pièce
--	---------------------------------	--	----	---------

1065290	20x1,9/2,0-G $\frac{3}{4}$ "FT Euro		25	1 pièce
----------------	-------------------------------------	--	----	---------

Uponor Smart manchon égal à sertir

 1089646	14x2,0-14x2,0		80	20 pièce
--	---------------	--	----	----------

Uponor Q&E bague évolution white

 1057454	20		520	20 pièce
--	----	--	-----	----------

Uponor MLCP RED tube

 1096010	14x1,6 240m		3120	240 m
--	-------------	--	------	-------

1096011	14x1,6 480m		3360	480 m
----------------	-------------	--	------	-------

Uponor Vario adaptateur à visser MLCP Red

 1000117	14x1,6- $\frac{3}{4}$ "Euro		80	20 pièce
--	-----------------------------	--	----	----------

Uponor MLCP Red raccord à sertir

 1048272	14x1,6-14x1,6		80	20 pièce
--	---------------	--	----	----------

N° art.	Dimension	UL	UE	unité
---------	-----------	----	----	-------

Uponor Minitec bague, coloris naturel

 1005263	9,9x1,1		1600	10 pièce
--	---------	--	------	----------

Uponor Minitec adaptateur pour collecteur

 1005266	9,9x1,1-G $\frac{3}{4}$ "Euro		100	10 pièce
--	-------------------------------	--	-----	----------

Uponor Minitec manchon avec bagues

 1005264	9,9x1,1		100	10 pièce
--	---------	--	-----	----------

Uponor Q&E té réduit, bague Minitec

 1020524	20xMinitec9,9xQ&E20		75	5 pièce
--	---------------------	--	----	---------

Uponor Minitec raccord mâle

 1005265	9,9-R $\frac{1}{2}$ "MT		100	10 pièce
--	-------------------------	--	-----	----------

Uponor Q&E manchon réduit Minitec

 1020518	20xMinitec9,9		150	5 pièce
--	---------------	--	-----	---------

Uponor Minitec raccord à compression

 1013426	9,9- $\frac{3}{4}$ "Euro		120	12 pièce
---	--------------------------	--	-----	----------

Uponor Minitec outil d'expansion

 1006247	9,9x1,1		11	1 Kit
--	---------	--	----	-------

Uponor Q&E outil d'évasement avec évasement c. M12/

 1119375	6bar 9,9RS/20		-	1 Kit
--	---------------	--	---	-------

Uponor Multi coude de guidage de tuyau

 1135490	10-12		360	60 pièce
--	-------	--	-----	----------

Uponor Multi coude de guidage de tuyau

 1135491	14-18		240	30 pièce
--	-------	--	-----	----------

1135492	20-22		140	35 pièce
----------------	-------	--	-----	----------

Uponor Multi

N° art.	Dimension	UL	UE	unité
---------	-----------	----	----	-------

Uponor Multi attaches de câble PA

 1005372	300mm	6000	100	pièce
1086531	200mm	10000	100	pièce

Remarque : vente par unité d'emballage.

Uponor Multi profilé en U rail fixation

 1005358	20mm c/c50mm 3m	30	3	m
--	-----------------	----	---	---

Uponor Multi folio PE

 1005051	0,1mm 75x2m	6900	150	m ²
--	-------------	------	-----	----------------

Uponor Multi folio PE

 1005049	0,2mm 60x1,25m	3375	75	m ²
--	----------------	------	----	----------------

Remarque : vendu par unité d'emballage de 1 rouleau

Uponor Multi clou pour folio

 1000016	l=25mm	5000	100	pièce
--	--------	------	-----	-------

Remarque : vente par unité d'emballage.

Uponor Multi ruban périph., auto-adhésif PE

 1013117	40m 100x10mm	-	240	m
--	--------------	---	-----	---

Remarque : vente par unité d'emballage.

Uponor Multi ruban périph. bav. autocol.

 1000080	150x10mm	-	200	m
--	----------	---	-----	---

Remarque : vente par unité d'emballage.

Uponor Multi bande périphérique

 1000079	150x8mm	-	200	m
--	---------	---	-----	---

Remarque : vente par unité d'emballage.

Uponor Multi profilé pour joint PP

 1090229	1800x100x10mm	720	18	m
--	---------------	-----	----	---

Uponor Multi tube de protection de joint

 1000082	20mm 300x5mm	1800	30	pièce
--	--------------	------	----	-------

N° art.	Dimension	UL	UE	unité
---------	-----------	----	----	-------

Uponor Multi set de marquage

 1000083	100mm	-	10	pièce
--	-------	---	----	-------

Uponor Multi mat. remp. pour nivellement

 1000052	100l	2500	100	l
--	------	------	-----	---

Remarque : vente par unité d'emballage de 1 sac = 100 l

Conduites de distribution 25–75 mm

N° art.	Dimension	UL	UE	unité
---------	-----------	----	----	-------

Uponor Uni Pipe PLUS tube nu en barre S

 1060785	25x2,5 3m		30	3 m
1060786	32x3,0 3m		21	3 m

Uponor MLC tube, blanc S

 1013448	40x4,0 3m		12	3 m
1021980	50x4,5 3m		12	3 m
1021981	63x6,0 3m		9	3 m
1013453	75x7,5 5m		255	5 m

Uponor S-Press PLUS manchon à sertir PPSU

 1039935	25-25		80	10 pièce
1039936	32-32		80	10 pièce

Uponor S-Press manchon égal PPSU

 1046401	40-40		960	5 pièce
1046402	50-50		576	3 pièce
1032881	63-63		384	1 pièce
1032882	75-75		384	1 pièce

Uponor S-Press PLUS manchon réduit PPSU

 1039940	32-25		80	10 pièce
--	-------	--	----	----------

Uponor S-Press manchon réduit PPSU

 1039941	40-25		960	5 pièce
1039942	40-32		960	5 pièce
1039943	50-32		1152	3 pièce

Uponor S-Press manchon réduit PPSU

 1046406	50-40		576	3 pièce
1032883	63-40		384	1 pièce
1032884	63-50		384	1 pièce
1032885	75-50		384	1 pièce
1032886	75-63		384	1 pièce

Uponor S-Press PLUS coude à sertir PPSU

 1039931	25-25		80	10 pièce
1039932	32-32		20	5 pièce

Uponor S-Press coude PPSU

 1046386	40-40		960	5 pièce
1046387	50-50		576	3 pièce
1032877	63-63		210	1 pièce
1032878	75-75		210	1 pièce

N° art.	Dimension	UL	UE	unité
---------	-----------	----	----	-------

Uponor S-Press coude 45° PPSU

 1046388	40-40		960	5 pièce
1046389	50-50		576	3 pièce
1032879	63-63		192	1 pièce
1032880	75-75		192	1 pièce

Uponor S-Press PLUS T à sertir PPSU

 1039946	25-25-25		20	5 pièce
1039947	32-32-32		20	5 pièce

Uponor S-Press T égal PPSU

 1046390	40-40-40		720	5 pièce
1046391	50-50-50		288	3 pièce
1032887	63-63-63		150	1 pièce
1032888	75-75-75		150	1 pièce

Uponor S-Press PLUS T filetage femelle

 1070598	25-Rp $\frac{1}{2}$ "FT-25		20	5 pièce
1070600	32-Rp $\frac{1}{2}$ "FT-32		20	5 pièce

Uponor S-Press T femelle

 1046922	40-Rp $\frac{1}{2}$ "FT-40		500	5 pièce
1046929	50-Rp1"FT-50		240	3 pièce

Uponor S-Press PLUS raccord mâle

 1070507	25-R $\frac{3}{4}$ "MT		80	10 pièce
1070508	25-R1"MT		40	5 pièce
1070509	32-R1"MT		40	5 pièce
1070510	32-R1 $\frac{1}{4}$ "MT		20	5 pièce

Uponor S-Press raccord mâle

 1046901	40-R1 $\frac{1}{4}$ "MT		960	5 pièce
1046902	40-R1 $\frac{1}{2}$ "MT		960	5 pièce
1046905	50-R1 $\frac{1}{2}$ "MT		1152	3 pièce
1046906	50-R2"MT		576	3 pièce
1032895	63-R2"MT		336	1 pièce
1032896	75-R2 $\frac{1}{2}$ "MT		336	1 pièce













Uponor S-Press PLUS raccord femelle

 1070519	25-Rp $\frac{3}{4}$ "FT		40	5 pièce
1070520	25-Rp1"FT		40	5 pièce
1070521	32-Rp1"FT		40	5 pièce
1070522	32-Rp1 $\frac{1}{4}$ "FT		20	5 pièce

Uponor S-Press raccord femelle

 1046903	40-Rp1 $\frac{1}{4}$ "FT		960	5 pièce
1046904	40-Rp1 $\frac{1}{2}$ "FT		960	5 pièce
1046907	50-Rp1 $\frac{1}{2}$ "FT		1152	3 pièce

Vue d'ensemble des actionneurs

Convient à	Moteur ancien	Moteur NOUVEAU 2024												
<p>Uponor Vario PLUS</p>  <p>Uponor Magna Distributeur de chauffage industriel</p>  <p>Uponor Vario Vanne de régulation</p>  <p>Uponor Vario Vanne RL</p>  <p>• Pièces de rechange Velta Kompakt et Velta Distributeur Euro</p>	<p>Uponor Vario PLUS Moteur PRO MT 30x1,5</p>  <table border="1"> <thead> <tr> <th>Typ</th> <th>Art.-Nr.</th> </tr> </thead> <tbody> <tr> <td>24 V </td> <td>1000138</td> </tr> <tr> <td>230 V </td> <td>1005605</td> </tr> </tbody> </table>	Typ	Art.-Nr.	24 V	1000138	230 V	1005605	<p>Uponor Vario PLUS moteur NC MT 30x1,5</p>  <table border="1"> <thead> <tr> <th>Typ</th> <th>Art.-Nr.</th> </tr> </thead> <tbody> <tr> <td>24 V </td> <td>1141679</td> </tr> <tr> <td>230 V </td> <td>1141678</td> </tr> </tbody> </table>	Typ	Art.-Nr.	24 V	1141679	230 V	1141678
Typ	Art.-Nr.													
24 V	1000138													
230 V	1005605													
Typ	Art.-Nr.													
24 V	1141679													
230 V	1141678													
<p>Vario S Distributeur inoxydable</p> 		<p>Uponor Vario moteur NC FT 30x1,5</p> 												
<p>Uponor Vario M</p> 	<p>Uponor Vario Moteur S</p>  <table border="1"> <thead> <tr> <th>Typ</th> <th>Art.-Nr.</th> </tr> </thead> <tbody> <tr> <td>24 V </td> <td>1087778</td> </tr> <tr> <td>230 V </td> <td>1087763</td> </tr> </tbody> </table>	Typ	Art.-Nr.	24 V	1087778	230 V	1087763	<table border="1"> <thead> <tr> <th>Typ</th> <th>Art.-Nr.</th> </tr> </thead> <tbody> <tr> <td>24 V </td> <td>1141677</td> </tr> <tr> <td>230 V </td> <td>1141676</td> </tr> </tbody> </table>	Typ	Art.-Nr.	24 V	1141677	230 V	1141676
Typ	Art.-Nr.													
24 V	1087778													
230 V	1087763													
Typ	Art.-Nr.													
24 V	1141677													
230 V	1141676													
<p>Pièce de rechange Uponor Fluvia T</p> 	<p>Uponor Vario B Moteur PRO FT 28x1,5</p>  <table border="1"> <thead> <tr> <th>Typ</th> <th>Art.-Nr.</th> </tr> </thead> <tbody> <tr> <td>24 V </td> <td>1007249</td> </tr> <tr> <td>230 V </td> <td>1022244</td> </tr> </tbody> </table>	Typ	Art.-Nr.	24 V	1007249	230 V	1022244	<p>Uponor Vario moteur Retrofit NC</p> 						
Typ	Art.-Nr.													
24 V	1007249													
230 V	1022244													
<p>Pièces de rechange</p> <ul style="list-style-type: none"> • Pièce de rechange Polytherm sans D, Polytherm DF • Unipipe • Vario S Distributeur en acier inoxydable ST FM, ST LS (jusqu'à 2018) • Pièce de rechange Chronatherm 	<p>Uponor Vario Retrofit set A-XXX</p>  <table border="1"> <thead> <tr> <th>Typ</th> <th>Art.-Nr.</th> </tr> </thead> <tbody> <tr> <td>24 V </td> <td>1083575</td> </tr> <tr> <td>230 V </td> <td>1090265</td> </tr> </tbody> </table>	Typ	Art.-Nr.	24 V	1083575	230 V	1090265	<table border="1"> <thead> <tr> <th>Typ</th> <th>Art.-Nr.</th> </tr> </thead> <tbody> <tr> <td>24 V </td> <td>1141681</td> </tr> <tr> <td>230 V </td> <td>1141680</td> </tr> </tbody> </table>	Typ	Art.-Nr.	24 V	1141681	230 V	1141680
Typ	Art.-Nr.													
24 V	1083575													
230 V	1090265													
Typ	Art.-Nr.													
24 V	1141681													
230 V	1141680													

Uponor Vario PLUS

N° art.	Dimension	UL	UE	unité
---------	-----------	----	----	-------

Uponor Vario PLUS collecteur polyamide

 1042420	LS 1x¾ Euro	10	1	paire
1030580	LS 3x¾ Euro	290	1	paire
1030581	LS 4x¾ Euro	225	1	paire
1030582	LS 6x¾ Euro	155	1	paire

Uponor Vario PLUS collecteur plancher

 1042471	FM 1x¾ Euro	10	1	paire
1030583	FM 3x¾ Euro	174	1	paire
1030584	FM 4x¾ Euro	135	1	paire
1030585	FM 6x¾ Euro	93	1	paire

Uponor Vario PLUS ensemble collecteur

 1009209	K1	248	1	pièce
---	----	-----	---	-------

Uponor Vario PLUS moteur NC

 OUT 1000138	24V MT30x1,5	10	1	pièce
OUT 1005605	230V MT30x1,5	10	1	pièce

Livraison dans la limite des stocks disponibles. L'article expire au cours de l'année.

Uponor Vario PLUS moteur NC

 NEW 1141678	MT 230V 1W IP54	100	1	pièce
NEW 1141679	MT 24V 1W IP54	100	1	pièce

Uponor Vario régulateur de pression différentielle compact

 1137437	G1 - G1	192	1	Kit
---	---------	-----	---	-----

Uponor Vario PLUS actionneur PRO DDC 100kOhm

 1005544	24V NC MT30x1,5 0-10V DC	100	1	pièce
---	--------------------------	-----	---	-------

Uponor Vario raccord de compression PEX

 1065283	14x2,0-G¾"FT Euro	25	1	pièce
1065284	16x1,8/2,0-G¾"FT Euro	25	1	pièce
1065286	17x2,0-G¾"FT Euro	25	1	pièce
1065290	20x1,9/2,0-G¾"FT Euro	25	1	pièce

Uponor Vario PLUS coude 90°

 1032702	122/42	5	1	paire
---	--------	---	---	-------

Uponor Vario PLUS ensemble de connexion

 1005227		10	1	Kit
---	--	----	---	-----

Uponor Vario PLUS raccord tuyau souple

 1009214	G¾ x ½	10	1	pièce
---	--------	----	---	-------

N° art.	Dimension	UL	UE	unité
---------	-----------	----	----	-------

Uponor Vario PLUS jeu d'entretoises

 1009215		40	4	pièce
---	--	----	---	-------

Uponor Vario PLUS kit isolation

 1063207		-	1	Kit
---	--	---	---	-----

Uponor Vario vanne de régulation G1-RP1

 NEW 1137413		10	1	Kit
--	--	----	---	-----

Uponor Vario PLUS thermomètre

 1034524	D=40mm	20	1	paire
---	--------	----	---	-------

Uponor Vario PLUS débitmètre

 1009217	4 l/min	20	1	pièce
---	---------	----	---	-------

Uponor Vario PLUS inser. vanne alim. scale 1-5

 1034523		-	20	pièce
--	--	---	----	-------

Uponor Vario PLUS insert. vanne ret.

 1005250		10	1	pièce
---	--	----	---	-------

Uponor Vario Insert. vanne retour

 1005099		10	1	pièce
---	--	----	---	-------

Uponor Vario poignée, blanc white

 1005101		-	1	pièce
---	--	---	---	-------

Uponor Vario poignée manuelle COMP

 1005104		100	10	pièce
---	--	-----	----	-------

Uponor Vario Insert. vanne aliment.

 1005098		-	1	pièce
---	--	---	---	-------

Uponor Vario kit adaptateur

 NEW 1141758	M, MAGNA, PLUS, S	50	1	Kit
--	-------------------	----	---	-----

Uponor Vario S

N° art.	Dimension	UL	UE	unité
---------	-----------	----	----	-------

Uponor Vario S collecteur inox FM



OUT	1086538	2x $\frac{3}{4}$ Euro	108	1	pièce
OUT	1086539	3x $\frac{3}{4}$ Euro	108	1	pièce
OUT	1086540	4x $\frac{3}{4}$ Euro	108	1	pièce
OUT	1086541	5x $\frac{3}{4}$ Euro	108	1	pièce
OUT	1086542	6x $\frac{3}{4}$ Euro	72	1	pièce
OUT	1086543	7x $\frac{3}{4}$ Euro	72	1	pièce
OUT	1086544	8x $\frac{3}{4}$ Euro	72	1	pièce
OUT	1086545	9x $\frac{3}{4}$ Euro	72	1	pièce
OUT	1086546	10x $\frac{3}{4}$ Euro	48	1	pièce
OUT	1086547	11x $\frac{3}{4}$ Euro	48	1	pièce
OUT	1086548	12x $\frac{3}{4}$ Euro	48	1	pièce
OUT	1088864	13x $\frac{3}{4}$ Euro	48	1	pièce
OUT	1088865	14x $\frac{3}{4}$ Euro	36	1	pièce
OUT	1088866	15x $\frac{3}{4}$ Euro	36	1	pièce
OUT	1088867	16x $\frac{3}{4}$ Euro	36	1	pièce

Livraison dans la limite des stocks disponibles. L'article expire au cours de l'année.

N° art.	Dimension	UL	UE	unité
---------	-----------	----	----	-------

Uponor Vario S collecteur inox LS



OUT	1088045	2x $\frac{3}{4}$ Euro	108	1	pièce
OUT	1088046	3x $\frac{3}{4}$ Euro	108	1	pièce
OUT	1088047	4x $\frac{3}{4}$ Euro	108	1	pièce
OUT	1088048	5x $\frac{3}{4}$ Euro	108	1	pièce
OUT	1088049	6x $\frac{3}{4}$ Euro	72	1	pièce
OUT	1088050	7x $\frac{3}{4}$ Euro	72	1	pièce
OUT	1088051	8x $\frac{3}{4}$ Euro	72	1	pièce
OUT	1088052	9x $\frac{3}{4}$ Euro	72	1	pièce
OUT	1088053	10x $\frac{3}{4}$ Euro	48	1	pièce
OUT	1088054	11x $\frac{3}{4}$ Euro	48	1	pièce
OUT	1088055	12x $\frac{3}{4}$ Euro	48	1	pièce
OUT	1088868	13x $\frac{3}{4}$ Euro	48	1	pièce
OUT	1088869	14x $\frac{3}{4}$ Euro	36	1	pièce
OUT	1088870	15x $\frac{3}{4}$ Euro	36	1	pièce
OUT	1088871	16x $\frac{3}{4}$ Euro	36	1	pièce

Livraison dans la limite des stocks disponibles. L'article expire au cours de l'année.

Uponor Vario S collecteur FM



NEW	1140833	2xG $\frac{3}{4}$ Euro - G1	108	1	pièce	180,46
NEW	1140834	3xG $\frac{3}{4}$ Euro - G1	108	1	pièce	233,60
NEW	1140835	4xG $\frac{3}{4}$ Euro - G1	90	1	pièce	288,55
NEW	1140836	5xG $\frac{3}{4}$ Euro - G1	90	1	pièce	341,69
NEW	1140837	6xG $\frac{3}{4}$ Euro - G1	90	1	pièce	395,72
NEW	1140838	7xG $\frac{3}{4}$ Euro - G1	54	1	pièce	448,86
NEW	1140839	8xG $\frac{3}{4}$ Euro - G1	54	1	pièce	502,91
NEW	1140840	9xG $\frac{3}{4}$ Euro - G1	54	1	pièce	556,04
NEW	1140841	10xG $\frac{3}{4}$ Euro - G1	54	1	pièce	611,00
NEW	1140842	11xG $\frac{3}{4}$ Euro - G1	54	1	pièce	663,06
NEW	1140843	12xG $\frac{3}{4}$ Euro - G1	54	1	pièce	718,17
NEW	1140844	13xG $\frac{3}{4}$ Euro - G1	36	1	pièce	788,41
NEW	1140845	14xG $\frac{3}{4}$ Euro - G1	36	1	pièce	843,06
NEW	1140846	15xG $\frac{3}{4}$ Euro - G1	36	1	pièce	905,60
NEW	1140847	16xG $\frac{3}{4}$ Euro - G1	36	1	pièce	925,35

Uponor Vario S collecteur LS



NEW	1140863	2xG $\frac{3}{4}$ Euro - G1	108	1	pièce	162,13
NEW	1140864	3xG $\frac{3}{4}$ Euro - G1	108	1	pièce	197,88
NEW	1140865	4xG $\frac{3}{4}$ Euro - G1	90	1	pièce	233,60
NEW	1140866	5xG $\frac{3}{4}$ Euro - G1	90	1	pièce	269,32
NEW	1140867	6xG $\frac{3}{4}$ Euro - G1	90	1	pièce	303,98
NEW	1140868	7xG $\frac{3}{4}$ Euro - G1	54	1	pièce	341,69
NEW	1140869	8xG $\frac{3}{4}$ Euro - G1	54	1	pièce	376,49
NEW	1140870	9xG $\frac{3}{4}$ Euro - G1	54	1	pièce	412,22
NEW	1140871	10xG $\frac{3}{4}$ Euro - G1	54	1	pièce	449,79
NEW	1140872	11xG $\frac{3}{4}$ Euro - G1	54	1	pièce	484,57
NEW	1140873	12xG $\frac{3}{4}$ Euro - G1	54	1	pièce	519,41
NEW	1140874	13xG $\frac{3}{4}$ Euro - G1	36	1	pièce	679,87
NEW	1140875	14xG $\frac{3}{4}$ Euro - G1	36	1	pièce	725,60
NEW	1140876	15xG $\frac{3}{4}$ Euro - G1	36	1	pièce	786,75
NEW	1140877	16xG $\frac{3}{4}$ Euro - G1	36	1	pièce	840,18

Uponor Vario S

N° art.	Dimension	UL	UE	unité
---------	-----------	----	----	-------

Uponor Vario moteur NC

 NEW 1141676	FT 230V 1W IP54	100	1	pièce
NEW 1141677	FT 24V 1W IP54	100	1	pièce

Uponor Vario kit adaptateur

 NEW 1141758	M, MAGNA, PLUS, S	50	1	Kit
--	-------------------	----	---	-----

Uponor Vario régulateur de pression différentielle compact

 1137437	G1 - G1	192	1	Kit
---	---------	-----	---	-----

Uponor Vario vanne de régulation G1-RP1

 1137413		10	1	Kit
---	--	----	---	-----

Uponor Vario 2 vannes d'arrêt à billes

 1059132	NP G1-G1	10	1	Kit
---	----------	----	---	-----

Uponor Vario vannes à billes

 1086558	¾-G1	10	1	Kit
---	------	----	---	-----

Uponor Vario coude vannes à bille

 1086559	Rp ¾" - G1"	-	1	Kit
---	-------------	---	---	-----

Uponor Vario vannes à billes, équerre

 1090732	G1-Rp1	260	1	Kit
---	--------	-----	---	-----

Uponor Vario rotule d'assemblage

 1058573	G1-G1A	30	1	pièce
---	--------	----	---	-------

Uponor Vario vanne de réglage fin

 1005107	½" - G¾	50	1	pièce
---	---------	----	---	-------

Uponor Vario vanne de fermeture retour

 1005108	½" - G¾	50	1	pièce
---	---------	----	---	-------

N° art.	Dimension	UL	UE	unité
---------	-----------	----	----	-------

Uponor Vario connexion HM horizontale

 1090730	G¾" 110mm	250	1	Kit
1090728	G1" 130mm	-	1	Kit

Uponor Vario connexion HM verticale

 1090731	G¾" 110mm	250	1	Kit
1090729	G1" 130mm	250	1	Kit

Uponor Vario joint pour capteur HM

 1007177	M10-5mm	-	1	pièce
---	---------	---	---	-------

Uponor Vario coude de connexion

 1000110	1"FT-1"MT	50	10	pièce
---	-----------	----	----	-------

Uponor Aqua PLUS b. d'ext. coll., j. pl.

 1001337	¾"FT	250	10	pièce
---	------	-----	----	-------

Uponor Vario S thermomètre S

 1086537		10	1	Kit
---	--	----	---	-----

Uponor Vario S vanne LS

 1088056		-	10	pièce
---	--	---	----	-------

Uponor Vario M

N° art.	Dimension	UL	UE	unité
---------	-----------	----	----	-------

Uponor Vario M collecteur av. débitmètre FM



1085944	2xG¾ Euro	80	1	pièce
1085945	3xG¾ Euro	80	1	pièce
1085946	4xG¾ Euro	80	1	pièce
1085947	5xG¾ Euro	80	1	pièce
1085948	6xG¾ Euro	80	1	pièce
1085949	7xG¾ Euro	80	1	pièce
1085950	8xG¾ Euro	80	1	pièce
1085951	9xG¾ Euro	80	1	pièce
1085952	10xG¾ Euro	80	1	pièce
1086250	11xG¾ Euro	108	1	pièce
1086251	12xG¾ Euro	108	1	pièce
1087129	13xG¾ Euro	30	1	pièce
1087130	14xG¾ Euro	30	1	pièce
1087131	15xG¾ Euro	30	1	pièce

Uponor Vario moteur NC



NEW 1141676	FT 230V 1W IP54	100	1	pièce
NEW 1141677	FT 24V 1W IP54	100	1	pièce

Uponor Vario kit adaptateur



NEW 1141758	M, MAGNA, PLUS, S	50	1	Kit
--------------------	-------------------	----	---	-----

N° art.	Dimension	UL	UE	unité
---------	-----------	----	----	-------

Uponor Vario régulateur de pression différentielle compact



1137437	G1 - G1	192	1	Kit
---------	---------	-----	---	-----

Uponor Vario M collecteur débitmètre



1121531	0-5l/min	10	1	pièce
---------	----------	----	---	-------

Uponor Vario M console



1087531		-	1	Kit
---------	--	---	---	-----

Uponor Vario M vanne de remplissage et de vidange



1120810		10	1	pièce
---------	--	----	---	-------

Uponor Vario vanne de régulation G1-RP1



NEW 1137413		10	1	Kit
--------------------	--	----	---	-----

Uponor Vario M vanne de retour



1085957		-	1	pièce
---------	--	---	---	-------

Uponor Vario M thermomètre



1085958		-	1	Kit
---------	--	---	---	-----

Uponor Vario M jeu étriers sécurité



1085959	3x2	-	1	Kit
---------	-----	---	---	-----

Cotes de montage armoires de distribution

chassis d'armoire		armoire de distribution largeur										
	Vario Armoire de distribution OW (pour montage en saillie)	L (mm)	450	600	750	900	1050	1200	1350	1550		
	Vario Armoire de distribution IW (pour montage encastré)	l1 (mm)		550	700	850	1000	1150	1300			

Variante	Configuration		convient pour nombre de circuits de chauffage									nh min IW (mm)	IW (OW) h1 (mm)
			OW / IW	-	2-4	5-7	8-10	11-13	14-15	-	-		
1	Vertical	sans / avec kit de raccordement Vario WMZ	OW / IW	-	2-4	5-7	8-10	11-13	14-15	-	-	95	80 (135)
2	Latéral	avec Vario vannes à bille	OW	2	3-5	6-8	9-11	12-14	15	-	-	80*	80 (135)
			IW		2-5								
3	Latéral	avec kit de raccordement Vario WMZ	OW / IW	-	-	2-3	4-6	7-9	10-12	13-15	-	95	80 (135)
4	Vertical	avec groupe de pompes Push 23 B	OW / IW	-	2-3	4-6	7-9	10-12	13-15	-	-	110*	110 (135)
5	Vertical	avec groupe de pompes MPG / Push 23 A	OW / IW	-	-	2-4	5-7	8-10	11-13	14-15	-	110*	110 (135)
6	Latéral	avec régulateur de pression différentielle Viva + Vario vannes à bille	OW / IW	-	2-4	5-7	8-10	11-13	14-15	-	-	80*	80 (135)
7	Latéral	avec régulateur de pression différentielle Viva et + Vario vannes à bille + kit de raccordement Vario WMZ	OW	-	-	2	3-5	6-8	9-11	12-14	15	95	95 (135)
			IW								-		
8	Vertical	avec régulateur de pression différentielle Viva + Vario vannes à bille avec / sans kit de raccordement Vario WMZ	OW / IW	-	2	3-5	6-8	9-11	12-14	15	-	95	95 (135)

1	Vertical	sans / avec kit de raccordement Vario WMZ	OW	2	3-5	6-8	9-10	11-13	14-16	-	-	95	80 (135)
			IW		2-5								
2	Latéral	avec Vario vannes à bille	OW	2-3	4-6	7-9	10-11	12-14	15-16	-	-	80*	80 (135)
			IW		2-6								
3	Latéral	avec kit de raccordement Vario WMZ	OW	-	-	2-4	5-7	8-10	11-12	13-15	16	95	80 (135)
			IW								-		
4	Vertical	avec groupe de pompes Push 23 B	OW / IW	-	2-4	5-7	8-10	11-12	13-15	16	-	110*	110 (135)
5	Vertical	avec groupe de pompes MPG / Push 23 A	OW / IW	-	2	3-5	6-8	9-10	11-13	14-16	-	110*	110 (135)
6	Latéral	avec régulateur de pression différentielle Viva + Vario vannes à bille	OW / IW	-	2-4	5-7	8-10	11-12	13-15	16	-	80*	80 (135)
7	Latéral	avec régulateur de pression différentielle Viva et + Vario vannes à bille + kit de raccordement Vario WMZ	OW	-	-	2	3-5	6-8	9-11	12-15	16	95	80 (135)
			IW								-		
8	Vertical	avec régulateur de pression différentielle Viva + Vario vannes à bille avec / sans kit de raccordement Vario WMZ	OW / IW	-	2-3	4-6	7-9	10-11	12-14	15-16	-	95	80 (135)

* plus 10 mm si la porte plastique est utilisée

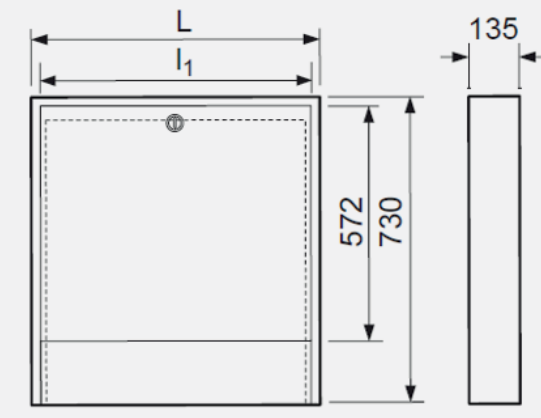
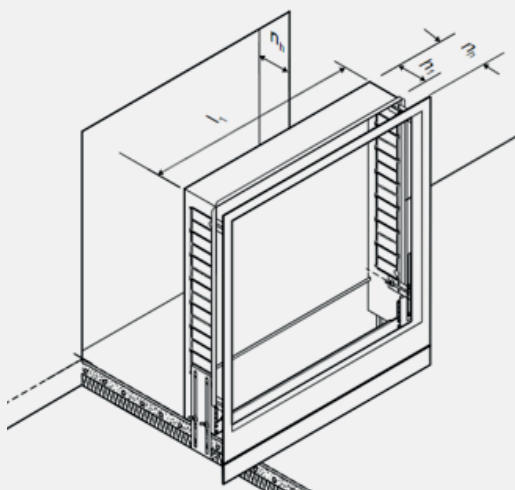

Uponor Vario

N° art.	Dimension	UL	UE	unité
---------	-----------	----	----	-------

Uponor Vario chassis d'armoire IW

 1093491	550x730x110mm	18	1	pièce
1093492	700x730x110mm	16	1	pièce
1093493	850x730x110mm	13	1	pièce
1093494	1000x730x110mm	12	1	pièce
1093495	1150x730x110mm	8	1	pièce
1093496	1300x730x110mm	8	1	pièce

Uponor Vario chassis d'armoire IW

 1093497	550x730x80mm	28	1	pièce
1093498	700x730x80mm	25	1	pièce
1093499	850x730x80mm	19	1	pièce
1093500	1000x730x80mm	18	1	pièce
1093501	1150x730x80mm	12	1	pièce
1093502	1300x730x80mm	12	1	pièce

Uponor Vario châssis/porte IW S

 1093528	550x730mm	5	1	pièce
1093541	700x730mm	5	1	pièce
1093542	850x730mm	5	1	pièce
1093543	1000x730mm	5	1	pièce
1093544	1150x730mm	5	1	pièce
1093546	1300x730mm	5	1	pièce

Uponor Vario serrure 2 clés porte

 1093554		200	1	pièce
--	--	-----	---	-------

Uponor Vario glissière pour armoire

 1093555		200	1	pièce
--	--	-----	---	-------

N° art.	Dimension	UL	UE	unité
---------	-----------	----	----	-------

Uponor Vario armoire de distribution OW

 1136215	450x730x135		25	1	pièce
1136216	600x730x135		17	1	pièce
1136217	750x730x135		15	1	pièce
1136218	900x730x135		12	1	pièce
1136219	1050x730x135		11	1	pièce
1136220	1200x730x135		7	1	pièce
1136221	1350x730x135		7	1	pièce

À partir d'une largeur d'armoire de 1200 x 730, 2 serrures sont nécessaires !

Uponor Magna armoire de distribution montée en surface





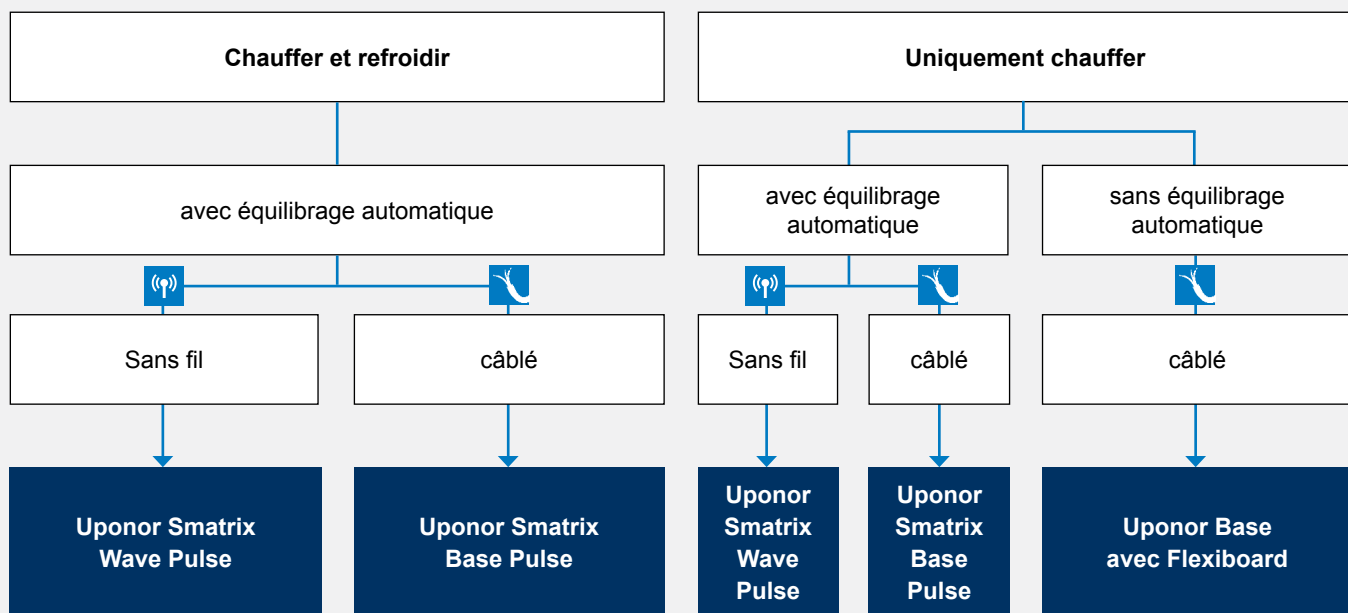

 1060553	1010x835x200mm	-	1	pièce
1060554	1910x835x200mm	-	1	pièce
1060555	2310x835x200mm	-	1	pièce

Régulations de la température de locaux individuels pour habitations



Chauffage surface

Guide-système Uponor pour les régulations de la température de locaux individuels pour le chauffage/refroidissement de surface dans les habitations

Uponor Smatrix	Description
 Uponor Smatrix Wave Pulse	Régulation de la température de locaux individuels sans fil commandée par appli pour chauffer et refroidir avec de nombreuses possibilités, p.ex. connectivité avec Smart Home (Amazon Alexa, Google Home) et Cloud
 Uponor Smatrix Base Pulse	Régulation de la température de locaux individuels câblée commandée par appli pour chauffer et refroidir avec de nombreuses possibilités, p.ex. connectivité avec Smart Home (Amazon Alexa, Google Home) et Cloud
 Uponor Smatrix Base PRO	Régulation de la température de locaux individuels câblée pour chauffer et refroidir pour les bâtiments commerciaux et les objets de grande taille
  Uponor Smatrix Style	Sonde ambiante design avec surveillance de l'humidité pour les régulations de température ambiantes Smatrix Wave/Base PULSE et Smatrix Base PRO
Uponor	Description
 Uponor Base	Régulation conventionnelle de la température de locaux individuels câblée 230 V pour un réglage simple de la température ambiante
Smatrix Move	Régulateur de la température de départ sur base de la température extérieure pour chauffer et refroidir

Eventail des fonctions Smatrix Wave/Base

Uponor Smatrix Technique de régulation	Version complète		sans Cloud		uniquement module de régulation	
	 +  +  + 	 + 	 +  + 			
	Smatrix Wave PULSE	Smatrix Wave PULSE	Smatrix Wave PULSE	Smatrix Wave PULSE	Smatrix Wave PULSE	Smatrix Wave PULSE
Accès distant	■	■				
Réglage confortable	■	■				
Programmes d'abaissement de la température	■	■				
Mises à jour par appli	■	■				
Connectivité Alexa	■	■				
Activation à distance d'autres composants par module à relais	■					
Accès local via WLAN	■	■	■	■		
Limitation maxi/mini de la température réglée	■	■	■	■		
Création d'un groupe de régulation comprenant 4 modules de régulation	■	■	■	■		
Possibilités de conversion chauffer/ refroidir étendues	■	■	■	■		
Mode central pour l'abaissement de la température	■	■	■	■		
Équilibrage automatique	■	■	■	■	■	■
Chauffer et refroidir	■	■	■	■	■	■
Barrette de contacteurs RF		■		■		■
Régulation d'éléments chauffants	■	■	■	■	■	■

Uponor Smatrix Wave / Pulse



N° art.	Dimension	UL	UE	unité
---------	-----------	----	----	-------

Uponor Smatrix Wave kit de démarrage Pulse S

 1093284			3	1	Kit
--	--	--	---	---	-----

Uponor Smatrix Wave kit de démarrage Pulse L

 1093287			2	1	Kit
--	--	--	---	---	-----

Uponor Smatrix interface com R-208 Pulse Pulse com R-208

 1093030			16	1	pièce
--	--	--	----	---	-------

Uponor Smatrix Wave contrôleur Pulse X-265 6X

 1093021			4	1	pièce
--	--	--	---	---	-------

Uponor Smatrix Wave module esclave Pulse M-262 6X

 1093133			16	1	pièce
--	--	--	----	---	-------

Uponor Smatrix Wave antenne Pulse A-265

 1093028			16	1	pièce
--	--	--	----	---	-------

Uponor Smatrix Wave module relais M-161

 1071673 2x			16	1	pièce
---	--	--	----	---	-------

Uponor Smatrix Wave thermostat D+RH style T-169 D+ RH

 1087816 blanc			180	1	pièce
--	--	--	-----	---	-------

 1087817 noir			180	1	pièce
---	--	--	-----	---	-------

Uponor Smatrix Wave capt. temp. RH Style T-161

 1087815			180	1	pièce
--	--	--	-----	---	-------

Uponor Smatrix Base cadre mural T-141

 1122237 RAL9016			20	1	pièce
--	--	--	----	---	-------

Uponor Smatrix Wave thermostat P+RH T-168 P+RH

 1086984 RAL9016			75	1	pièce
--	--	--	----	---	-------

N° art.	Dimension	UL	UE	unité
---------	-----------	----	----	-------

Uponor Smatrix Wave thermostat D T-166 D

 1086982 RAL9016			75	1	pièce
--	--	--	----	---	-------

Uponor Smatrix Wave thermostat standard T-165 POD standard

 1086981 RAL9016			75	1	pièce
--	--	--	----	---	-------

Uponor Smatrix Wave sonde d'ambiance BM T-163 public

 1086979 RAL9016			75	1	pièce
--	--	--	----	---	-------

Uponor Smatrix Wave tête thermostatique T-162

 1071660			16	1	pièce
--	--	--	----	---	-------

Uponor Smatrix châssis mural T-X A-1XX

 1086986 RAL9016			250	1	pièce
--	--	--	-----	---	-------

Uponor Smatrix sonde sol/distance S-1XX

 1071684			63	1	pièce
--	--	--	----	---	-------

Uponor Smatrix relais chaud froid M-1XX

1083576 24V			84	1	pièce
--------------------	--	--	----	---	-------

Uponor Smatrix relais chaud froid M-1XX

 1083577 230V			16	1	pièce
---	--	--	----	---	-------

Uponor Vario moteur NC

 NEW 1141677 FT 24V 1W IP54			100	1	pièce
--	--	--	-----	---	-------

Uponor Vario actionneur Retrofit A-XXX

 OUT 1083575 24V, NC, 1W			100	1	Kit
---	--	--	-----	---	-----

Livraison dans la limite des stocks disponibles. L'article expire au cours de l'année.

Uponor Vario Moteur retrofit NC

 NEW 1141681 FT 24V 1W IP54			100	1	pièce
--	--	--	-----	---	-------

Uponor Vario PLUS moteur NC

 NEW 1141679 MT 24V 1W IP54			100	1	pièce
--	--	--	-----	---	-------

Uponor Smatrix Base / Pulse



N° art.	Dimension	UL	UE	unité
---------	-----------	----	----	-------

Uponor Smatrix Base kit de démarrage Pulse S

 1093280			3	1	Kit
--	--	--	---	---	-----

Uponor Smatrix Base kit de démarrage Pulse L

 1093282			2	1	Kit
--	--	--	---	---	-----

Uponor Smatrix interface com R-208 Pulse Pulse com R-208

 1093030			16	1	pièce
--	--	--	----	---	-------

Uponor Smatrix Base régulation Pulse X-245 BUS 6X

 1093017			4	1	pièce
--	--	--	---	---	-------

Uponor Smatrix Base module esclave Pulse M-242 BUS 6X

 1093134			16	1	pièce
--	--	--	----	---	-------

Uponor Smatrix Base ext. pour controleur Pulse M-243 BUS 6X

 1093135			16	1	pièce
--	--	--	----	---	-------

Uponor Smatrix Base thermostat D+RH style T-149 Bus D+ RH

 1087813 blanc			180	1	pièce
--	--	--	-----	---	-------

 1087814 noir			180	1	pièce
---	--	--	-----	---	-------

Uponor Smatrix Base PRO capt. temp. RH style T-141 Bus flush

 1087812			180	1	pièce
--	--	--	-----	---	-------

Uponor Smatrix Base cadre mural T-141

 1122237 RAL9016			20	1	pièce
--	--	--	----	---	-------

Uponor Smatrix Base thermostat P+RH T-148 Bus P+RH

 1086977 RAL9016			75	1	pièce
--	--	--	----	---	-------

N° art.	Dimension	UL	UE	unité
---------	-----------	----	----	-------

Uponor Smatrix Base thermostat D T-146 Bus D

 1086976 RAL9016			75	1	pièce
--	--	--	----	---	-------

Uponor Smatrix Base thermostat standard T-145 Bus POD standard

 1086975 RAL9016			75	1	pièce
--	--	--	----	---	-------

Uponor Smatrix Base thermostat encastré T-144 Bus flush

 1086973 RAL9016			60	1	pièce
--	--	--	----	---	-------

Uponor Smatrix Base thermostat public T-143 Bus public

 1086972 RAL9016			75	1	pièce
--	--	--	----	---	-------

Uponor Smatrix sonde sol/distance S-1XX

 1071684			63	1	pièce
--	--	--	----	---	-------

Uponor Smatrix Base plaque murale Style T-149 A-14X

 1087821			90	1	pièce
--	--	--	----	---	-------

Uponor Smatrix Base plaque murale style T-149 A-14x black

 1087822			90	1	pièce
--	--	--	----	---	-------

Uponor Smatrix châssis mural T-X A-1XX

 1086986 RAL9016			250	1	pièce
--	--	--	-----	---	-------

Uponor Smatrix Base cable bus A-145

 1071670 50m			2	1	pièce
--	--	--	---	---	-------

Uponor Smatrix Base / Pulse



N° art.	Dimension	UL	UE	unité
---------	-----------	----	----	-------

Uponor Smatrix relais chaud froid M-1XX



1083576	24V		84	1 pièce
---------	-----	--	----	---------

Uponor Smatrix relais chaud froid M-1XX



1083577	230V		16	1 pièce
---------	------	--	----	---------

N° art.	Dimension	UL	UE	unité
---------	-----------	----	----	-------

Uponor Vario moteur NC



NEW 1141677	FT 24V 1W IP54		100	1 pièce
--------------------	----------------	--	-----	---------

Uponor Vario actionneur Retrofit A-XXX



OUT 1083575	24V, NC, 1W		100	1 Kit
--------------------	-------------	--	-----	-------

Livraison dans la limite des stocks disponibles. L'article expire au cours de l'année.

Uponor Vario moteur retrofit NC



NEW 1141680	FT 230V 1W IP54		100	1 pièce
--------------------	-----------------	--	-----	---------

NEW 1141681	FT 24V 1W IP54		100	1 pièce
--------------------	----------------	--	-----	---------

Uponor Vario PLUS moteur NC



NEW 1141678	MT 230V 1W IP54		100	1 pièce
--------------------	-----------------	--	-----	---------

NEW 1141679	MT 24V 1W IP54		100	1 pièce
--------------------	----------------	--	-----	---------

Uponor Smatrix Base PRO



N° art.	Dimension	UL	UE	unité
---------	-----------	----	----	-------

Uponor Smatrix Base PRO régulateur X-147 Bus

 1087162	6x		4	1 pièce
--	----	--	---	---------

Uponor Smatrix Base module d'extension M-140 Bus

 1071686	6x		16	1 pièce
--	----	--	----	---------

Uponor Smatrix Base module d'extension M-141 Bus

 1071651	8X		16	1 pièce
--	----	--	----	---------

Uponor Smatrix Base PRO interface I-147 Bus

 1087161			7	1 pièce
--	--	--	---	---------

N° art.	Dimension	UL	UE	unité
---------	-----------	----	----	-------

Uponor Smatrix Base PRO capt. temp. RH style T-141 Bus flush

 1087812			180	1 pièce
--	--	--	-----	---------

Uponor Smatrix Base cadre mural T-141

 1122237	RAL9016		20	1 pièce
--	---------	--	----	---------

Uponor Smatrix Base commutateur horaire I-143 Bus

 1086978	RAL9016		75	1 pièce
--	---------	--	----	---------

Uponor Base



N° art.	Dimension	UL	UE	unité
Uponor Base module de régulation X-23				
 1058426	230V		200	1 pièce
Uponor Base X-24				
 1088331	6x 230V	-		1 pièce
Uponor Base Flexiboard logiq. pompe X-25				
 1089086	6x 230V	-		1 pièce
Uponor Base X-26				
 1089087	8x 230V	-		1 pièce
Uponor Base Flexiboard av. log. pompe X-27				
 1089088	8x 230V	-		1 pièce
Uponor Base thermostat standard T-23 standard				
 1058422	230V RAL9010		160	1 pièce
Uponor Base thermostat encastrable T-24 flush				
 1058423	230V	-		1 pièce
Uponor Base thermostat C/R T-25 H/C				
 1058424	230V	-		1 pièce
Uponor Base T-27				
 1120075	230V RAL9016		75	1 pièce
Uponor Base thermostat d'ambiance prog. T-26 dig. prog.				
 1058425	230V RAL9010	-		1 pièce
Uponor Base capteur à distance				
 1047459	230V	-		1 pièce

N° art.	Dimension	UL	UE	unité
Uponor Vario PLUS actionneur thermique NC				
 OUT 1005605	230V MT30x1,5		10	1 pièce
Livraison dans la limite des stocks disponibles. L'article expire au cours de l'année.				
Uponor Vario PLUS moteur NC				
 NEW 1141678	MT 230V 1W IP54		100	1 pièce
Uponor Vario B moteur NC				
 OUT 1022244	230V FT28x1,5		10	1 pièce
Livraison dans la limite des stocks disponibles. L'article expire au cours de l'année.				
Uponor Vario moteur NC				
 NEW 1141676	FT 230V 1W IP54		100	1 pièce
Uponor Vario moteur retrofit NC				
 NEW 1141680	FT 230V 1W IP54		100	1 pièce

Régulation de la température ambiante

N° art.	Dimension	UL	UE	unité
---------	-----------	----	----	-------

N° art.	Dimension	UL	UE	unité
---------	-----------	----	----	-------

Uponor Smatrix Move

Uponor Smatrix Move régulateur X-157 Wired



1071693		4	1	Kit
---------	--	---	---	-----

Uponor Smatrix Move sonde retour S-152



1071661	3m	63	1	pièce
---------	----	----	---	-------

Uponor Smatrix Move sonde extérieure S-1XX



1071671		45	1	pièce
---------	--	----	---	-------

Uponor Smatrix relais chaud froid M-1XX



1083577	230V	16	1	pièce
---------	------	----	---	-------

Uponor Smatrix Move actionneur motorisé 230V



1002357		-	1	pièce
---------	--	---	---	-------

Régulation de la température ambiante

N° art.	Dimension	UL	UE	unité
---------	-----------	----	----	-------

N° art.	Dimension	UL	UE	unité
---------	-----------	----	----	-------

Uponor Fluvia

Uponor Fluvia T module de régulation Push-12-CH-X

	1085982		50	1	pièce
---	----------------	--	----	---	-------

Uponor Fluvia T groupe de pompe Push-12 AC-G

	1095128		60	1	pièce
---	----------------	--	----	---	-------

Uponor Fluvia adaptateur à visser en Y

	1005675	2xG $\frac{3}{4}$ - $\frac{3}{4}$ "Euro	50	1	Kit
---	----------------	---	----	---	-----

Uponor Vario vanne remplissage/vidange

	1061802	$\frac{3}{4}$ " - $\frac{3}{4}$ "	10	1	Kit
---	----------------	-----------------------------------	----	---	-----

Uponor Aqua PLUS b. d'ext. coll., j. pl.

	1001337	$\frac{3}{4}$ "FT	250	10	pièce
---	----------------	-------------------	-----	----	-------

Uponor Fluvia Move groupe de pompage Push-23-A-AC

	1085008		30	1	pièce
---	----------------	--	----	---	-------

Uponor Fluvia T groupe de pompe Push-23-B-W

	1078304		55	1	pièce
---	----------------	--	----	---	-------

Uponor Fluvia Move groupe de pompe MPG-10-A-W

	1078306		30	1	pièce
---	----------------	--	----	---	-------

Uponor Fluvia groupe de pompe MPG-10-B-W

	1078307		30	1	pièce
---	----------------	--	----	---	-------

Uponor Vario rotule d'assemblage

	1058573	G1-G1A	30	1	pièce
---	----------------	--------	----	---	-------

Uponor Fluvia limiteur de temp. max.

	1005504	5-60deg		10	1	pièce
---	----------------	---------	--	----	---	-------

Uponor Fluvia Move groupe de pompe PPG-30-A-W

	1084143			22	1	pièce
---	----------------	--	--	----	---	-------





Uponor Smatrix Move actionneur 24V (0-10V) pro

	1002356	A-15x 24V 0-10V		-	1	pièce
---	----------------	-----------------	--	---	---	-------

Uponor Smatrix Move actionneur motorisé 230V

	1002357			-	1	pièce
--	----------------	--	--	---	---	-------

Technologie de connexion, raccords et outillages pour Uponor Ecoflex





Type	Dimension [mm]	Tube intérieure	Matériau d'isolation	Tube extérieur	Température / Pression de la barre	Longueur [m]	N° art.	Certifications
VIP Thermo Single 	40 x 3,7/140	PE-Xa + EVOH	VIP + Mousse PEX	PE-HD	max. 95 °C / 6 bar	200	1095714	Certification de système CSTB + KOMO
	50 x 4,6/140					200	1095715	
	63 x 5,8/140					200	1095716	
	75 x 6,8/140					200	1095717	
	90 x 8,2/175					100	1095718	
	110 x 10,0/175					100	1095719	
	125 x 11,4/200					120	1095720	
VIP Thermo Twin 	2x25 x 2,3/140	PE-Xa + EVOH	VIP + Mousse PEX	PE-HD	max. 95 °C / 6 bar	200	1118580	Certification de système CSTB + KOMO
	2x32 x 2,9/140					200	1118581	
	2x40 x 3,7/175					200	1118582	
	2x50 x 4,6/175					200	1118583	
	2x63 x 5,8/200					100	1118584	
	2x75 x 6,8/250					100	1118585	
	Thermo Single 					25 x 2,3/140	PE-Xa + EVOH	
32 x 2,9/140		200	1018110					
40 x 3,7/175		200	1018111					
50 x 4,6/175		200	1018112					
63 x 5,8/175		200	1018113					
75 x 6,8/200		100	1018114					
90 x 8,2/200		100	1018115					
110 x 10,0/200		100	1018116					
Thermo Twin 		2x25 x 2,3/175	PE-Xa + EVOH	Mousse PEX	PE-HD	max. 95 °C / 6 bar		200
	2x32 x 2,9/175	200					1018135	
	2x40 x 3,7/175	200					1018136	
	2x50 x 4,6/200	100					1018137	
	2x63 x 5,8/200	100					1018138	
	Thermo Mini 	25 x 2,3/68					PE-Xa + EVOH	Mousse PEX
32 x 2,9/68		200	1018133					

Technologie et outils de connexion

	Wipex raccord fileté mâle		Ecoflex raccord fileté mâle	Quick & Easy		Bagues avec bord d'arrêt	
	PN6 + pâte graphite + pince écarteur + inbus	PN6 + pâte graphite + inbus	PN6 + pâte graphite + inbus	Outillages d'expansion M18 6 bar	M18 VLD	natural	blanc













Accessoires

Embout terminal EPDM

	•			•	•	•	
	•				•	•	
		•			•	•	
		•			•	•	
		•					
		•	•				
	•			•			•
	•			•			•
	•			•	•	•	
	•			•	•	•	
	•			•	•	•	
	•	•		•	•	•	
		•			•	•	
		•			•	•	
		•			•	•	
	•			•	•	•	•
	•			•	•	•	•
	•			•	•	•	
	•			•	•	•	
	•			•			•
	•			•			•

Distribution

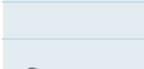
Technologie de connexion, raccords et outillages pour Uponor Ecoflex

Type	Dimension [mm]	Tube intérieure	Matériau d'isolation	Tube extérieur	Température / Pression de la barre	Longueur [m]	N° art.	Certifications	Accessoires Embout terminal EPDM
	40 x 5,5/140	PE-Xa	VIP + Mousse PEX	PE-HD	max. 95 °C / 10 bar	200	1119047	DVGW, ÖVGW. Certification de système Kiwa	
	50 x 6,9/140					200	1119048		
	63 x 8,6/140					200	1119049		
	25 x 3,5-20 x 2,8/140	PE-Xa	VIP + Mousse PEX	PE-HD	max. 95 °C / 10 bar	200	1119053	DVGW, ÖVGW. Certification de système Kiwa	
	32 x 4,4-20 x 2,8/140					200	1119054		
	40 x 5,5-25 x 3,5/140					200	1119055		
	50 x 6,9-32 x 4,4/175					200	1119056		
	25 x 3,5/140	PE-Xa	Mousse PEX	PE-HD	max. 95 °C / 10 bar	200	1018117	DVGW, ÖVGW	
	32 x 4,4/140					200	1018118		
	40 x 5,5/175					200	1018119		
	50 x 6,9/175					200	1018120		
	63 x 8,6/175					200	1018121		
	25 x 3,5-25 x 3,5/175	PE-Xa	Mousse PEX	PE-HD	max. 95 °C / 10 bar	200	1018139	DVGW, ÖVGW	
	32 x 4,4-25 x 3,5/175					200	1018140		
	40 x 5,5-25 x 3,5/175					200	1018141		
	50 x 6,9-25 x 3,5/175					200	1018142		
	2x25 x 2,3-2x25 x 3,5/175	PE-Xa + EVOH + PE-Xa	Mousse PEX	PE-HD	max. 95 °C / 6 / 10 bar	200	1018147	DVGW, ÖVGW	
	2x32 x 2,9-2x25 x 3,5/175					200	1018148		
	2x32 x 2,9-32 x 4,4-25 x 3,5/175					200	1018149		
	25 x 2,3/68	PE 100-RC noir avec couche bleue	Mousse PEX	PE-HD	20 °C / 16 bar	200	1095722	DVGW	
	32 x 2,9/68					200	1095723		
	40 x 3,7/140					200	1095724		
	50 x 4,6/140					200	1095725		
	63 x 5,8/140					200	1095726		
	75 x 6,8/175					100	1095727		
	90 x 8,2/175					100	1095728		
	110 x 10,0/200					100	1095729		
	25 x 2,3/68	PE 100-RC noir avec couche bleue	Mousse PEX	PE-HD	20 °C / 16 bar	150	1095730	DVGW	
	avec câble antigel					150	1095731		
	32 x 2,9/68					150	1095734		
	40 x 3,7/140					150	1095736		
	50 x 4,6/140					150	1095737		
	63 x 5,8/140					150	1095738		
	75 x 6,8/175					100	1095739		
	90 x 8,2/200					100	1095740		
110 x 10,0/200	100	1095740							

EAU CHAUDE SANITAIRE

CHAUFFAGE ET EAU CHAUDE SANITAIRE

EAU SANITAIRE FROIDE ET RAFRAICHISSEMENT

EAU SANITAIRE FROIDE

Système de distribution Uponor Ecoflex

N° art.	Dimension	UL	UE	unité
---------	-----------	----	----	-------

Uponor Ecoflex VIP Thermo

Uponor Ecoflex VIP Thermo Single

 1095714	40x3,7/140	-		200 m
1095715	50x4,6/140	-		200 m
1095716	63x5,8/140	-		200 m
1095717	75x6,8/140	-		200 m
1095718	90x8,2/175	-		150 m
1095719	110x10,0/175	-		150 m
1095720	125x11,4/200	-		120 m

Uponor Ecoflex VIP Thermo Twin

 1118580	2x25x2,3/140	-		200 m
1118581	2x32x2,9/140	-		200 m
1118582	2x40x3,7 /175	-		200 m
1118583	2x50x4,6/175	-		200 m
1118584	2x63x5,8/200	-		100 m
1118585	2x75x6,8/250	-		100 m



N° art.	Dimension	UL	UE	unité
---------	-----------	----	----	-------

Uponor Ecoflex Thermo

Uponor Ecoflex Thermo Single

 1018109	25x2,3/140	-		200 m
1018110	32x2,9/140	-		200 m
1018111	40x3,7/175	-		200 m
1018112	50x4,6/175	-		200 m
1018113	63x5,8/175	-		200 m
1018114	75x6,8/200	-		100 m
1018115	90x8,2/200	-		100 m
1018116	110x10,0/200	-		100 m

Uponor Ecoflex Thermo Twin

 1018134	2x25x2,3/175	-		200 m
1018135	2x32x2,9/175	-		200 m
1018136	2x40x3,7 /175	-		200 m
1018137	2x50x4,6/200	-		100 m
1018138	2x63x5,8/200	-		100 m

Uponor Ecoflex Thermo Mini

 1018132	25x2,3/68	-		200 m
1018133	32x2,9/68	-		200 m
1095574	32x2,9/68 L=25m	50		25 m



Uponor Ecoflex Thermo Mini
Le raccordement de la pompe à chaleur monobloc intelligent: petit rayon de courbure, facile à installer!

Système de distribution Uponor Ecoflex

N° art. Dimension UL UE unité

Uponor Ecoflex VIP Aqua

Uponor Ecoflex VIP Aqua Single

	1119047	40x5,5/140	-	200 m
	1119048	50x6,9/140	-	200 m
	1119049	63x8,6/140	-	200 m

Uponor Ecoflex VIP Aqua Twin

	1119053	25x3,5-20x2,8/140	-	200 m
	1119054	32x4,4-20x2,8/140	-	200 m
	1119055	40x5,5-25x3,5/140	-	200 m
	1119056	50x6,9-32x4,4/175	-	200 m



N° art. Dimension UL UE unité

Uponor Ecoflex Aqua

Uponor Ecoflex Aqua Single

	1018117	25x3,5/140	-	200 m
	1018118	32x4,4/140	-	200 m
	1018119	40x5,5/175	-	200 m
	1018120	50x6,9/175	-	200 m
	1018121	63x8,6/175	-	200 m

Uponor Ecoflex Aqua Twin

	1018139	25x3,5-25x3,5/175	-	200 m
	1018140	32x4,4-25x3,5/175	-	200 m
	1018141	40x5,5-25x3,5/175	-	200 m
	1018142	50x6,9-25x3,5/175	-	200 m

Uponor Ecoflex Quattro

Uponor Ecoflex Quattro

	1018147	2x25x2,3-2x25x3,5/175	-	200 m
	1018148	2x32x2,9-2x25x3,5/175	-	200 m
	1018149	2x32x2,9-32x4,4-25x3,5/175	-	200 m

Système de distribution Uponor Ecoflex

N° art. Dimension UL UE unité

Uponor Ecoflex Supra

Uponor Ecoflex Supra

	1095722	25x2,3/68	-	200 m
	1095723	32x2,9/68	-	200 m
	1095724	40x3,7/140	-	200 m
	1095725	50x4,6/140	-	200 m
	1095726	63x5,8/140	-	200 m
	1095727	75x6,8/175	-	150 m
	1095728	90x8,2/175	-	100 m
	1095729	110x10,0/200	-	100 m

N° art. Dimension UL UE unité

Uponor Ecoflex Supra PLUS

Uponor Ecoflex Supra PLUS cable

	1095730	25x2,3/68 1x10W/m	-	150 m
	1095731	32x2,9/68 1x10W/m	-	150 m
	1095734	40x3,7/140 1x10W/m	-	150 m
	1095736	50x4,6/140 1x10W/m	-	150 m
	1095737	63x5,8/140 1x10W/m	-	150 m
	1095738	75x6,8/175 1x10W/m	-	150 m
	1095739	90x8,2/200 1x10W/m	-	100 m
	1095740	110x10,0/200 1x10W/m	-	100 m

Uponor Ecoflex Supra PLUS définir

	1120124	25+32/68	-	1	Kit
	1120126	40+50+63/140	-	1	Kit
	1120127	75/175	-	1	Kit
	1120128	90+110/200	-	1	Kit

Uponor Ecoflex Supra PLUS régulateur 150

	1120123		50	1	pièce
--	----------------	--	----	---	-------

Uponor Ecoflex Supra PLUS kit électrique S1

	1042310		1	1	pièce
---	----------------	--	---	---	-------

Uponor Ecoflex Supra PLUS kit électrique S2

	1042311		1	1	pièce
---	----------------	--	---	---	-------

Uponor Ecoflex Supra PLUS té

	1061641	140/90/68	5	1	pièce
	1061642	200/175/140	3	1	pièce

Uponor Ecoflex bague réduction

	1060991	200/68	8	1	pièce
---	----------------	--------	---	---	-------

Uponor Wipex

N° art.	Dimension	UL	UE	unité
---------	-----------	----	----	-------

Uponor Wipex raccord fileté mâle PN6

 1018328	25x2,3-G1	40	1	pièce
1018329	32x2,9-G1	20	1	pièce
1018330	40x3,7-G1 ¼	10	1	pièce
1018331	50x4,6-G1 ¼	10	1	pièce
1018332	63x5,8-G2	8	1	pièce
1018333	75x6,8-G2	6	1	pièce
1018334	90x8,2-G3	4	1	pièce
1018335	110x10,0-G3	3	1	pièce

Uponor Ecoflex raccord fileté mâle PN6

 1078368	125x11,4-R4	-	1	pièce
--	-------------	---	---	-------

Uponor Ecoflex raccord fileté mâle PN10

 1091505	20x2,8-¾"	10	1	pièce
--	-----------	----	---	-------

Uponor Wipex raccord fileté mâle PN10

 1018336	25x3,5-G1	40	1	pièce
1018338	32x4,4-G1	20	1	pièce
1018339	40x5,5-G1 ¼	10	1	pièce
1018340	50x6,9-G1 ¼	10	1	pièce
1018341	63x8,6-G2	8	1	pièce

Uponor Wipex manchon égal Wipex PN6

 1042972	25x2,3-25x2,3	30	1	pièce
1042973	32x2,9-32x2,9	25	1	pièce
1042980	40x3,7-40x3,7	15	1	pièce
1042984	50x4,6-50x4,6	10	1	pièce
1042981	63x5,8-63x5,8	5	1	pièce
1042985	75x6,8-75x6,8	3	1	pièce
1042986	90x8,2-90x8,2	4	1	pièce
1042987	110x10-110x10	2	1	pièce

Uponor Ecoflex manchon PN6

 1078365	125x11,4-125x11,4	-	1	pièce
--	-------------------	---	---	-------

Uponor Wipex manchon égal Wipex PN10

 1042970	25x3,5-25x3,5	40	1	pièce
1042974	32x4,4-32x4,4	25	1	pièce
1042979	40x5,5-40x5,5	15	1	pièce
1042983	50x6,9-50x6,9	10	1	pièce
1042982	63x8,6-63x8,6	4	1	pièce

N° art.	Dimension	UL	UE	unité
---------	-----------	----	----	-------

Uponor Wipex té femelle

 1018345	G1-G1-G1	20	1	pièce
1018346	G1 ¼-G1 ¼-G1 ¼	10	1	pièce
1018347	G2-G2-G2	4	1	pièce
1018348	G3-G3-G3	3	1	pièce

Uponor Ecoflex té femelle

 1078367	Rp4-Rp4-Rp4	-	1	pièce
--	-------------	---	---	-------

Uponor Wipex coude

 1018350	G1-G1	20	1	pièce
1018351	G1 ¼-G1 ¼	15	1	pièce
1018352	G2-G2	5	1	pièce
1018353	G3-G3	2	1	pièce

Uponor Ecoflex coude

 1078366	Rp4-Rp4	-	1	pièce
--	---------	---	---	-------

Uponor Wipex manchon femelle

 1018355	G1-G1	40	1	pièce
1018356	G1 ¼-G1 ¼	25	1	pièce
1018357	G2-G2	15	1	pièce
1018358	G3-G3	10	1	pièce

Uponor Wipex réduction

 1018368	G1 ¼-G1	25	1	pièce
1018369	G1 ½-G1 ¼	25	1	pièce
1018371	G2-G1	15	1	pièce
1018372	G2-G1 ¼	15	1	pièce
1018373	G2 ½-G2	6	1	pièce
1018374	G3-G1	6	1	pièce
1018375	G3-G1 ¼	10	1	pièce
1018376	G3-G2	10	1	pièce
1009052	G4-G3	6	1	pièce

Uponor Ecoflex réduction mâle-femelle

 1078369	R4-G3	6	1	pièce
--	-------	---	---	-------

Uponor Wipex

N° art.	Dimension	UL	UE	unité
---------	-----------	----	----	-------

Uponor Wipex bride filetée filet femelle

	1018359	F25/4-85/G1	10	1	pièce
	1018360	F32/4-100/G1 ¼	5	1	pièce
	1018361	F40/4-110/G1 ½	5	1	pièce
	1018362	F50/4-125/G2	4	1	pièce
	1018363	F65/8-145/2 ½	3	1	pièce
	1018364	F80/8-160/G3	3	1	pièce
	1018365	F100/8-180/G4	3	1	pièce

Uponor Ecoflex bride

	1078370	F100/8-180/Rp4	-	1	pièce
---	----------------	----------------	---	---	-------

Uponor Wipex mamelon fileté filet mâle

	1045455	G1	20	1	pièce
	1045456	G1 ¼-G1	20	1	pièce
	1045457	G1 ¼	15	1	pièce
	1065442	G1¼ 120mm	8	1	pièce
	1045458	G2-G1 ¼	10	1	pièce
	1045459	G2	10	1	pièce
	1065444	G2 120mm	3	1	pièce
	1045460	G3-G2	3	1	pièce
	1045461	G3	2	1	pièce

Uponor Wipex man. pt fixe fil.m/fil.fem

	1018302	G1	30	1	pièce
	1018303	G1 ¼	10	1	pièce
	1018304	G2	5	1	pièce
	1018305	G3	5	1	pièce

N° art.	Dimension	UL	UE	unité
---------	-----------	----	----	-------

Uponor Ecoflex accouplement à souder ST PN6

	1094013	EU+GOST 25x2,3-26,9	-	1	pièce
	1094014	EU 32x2,9-33,7	-	1	pièce
	1094015	EU 40x3,7-42,4	-	1	pièce
	1094016	EU 50x4,6-48,3	-	1	pièce
	1094017	EU 63x5,8-60,3	-	1	pièce
	1094018	EU+GOST 75x6,8-76,1	-	1	pièce
	1094019	EU+GOST 90x8,2-88,9	-	1	pièce
	1094020	EU 110x10,0-114,3	-	1	pièce
	1094021	EU+GOST 125x11,4-114,3	-	1	pièce

Uponor Wipex adaptateur S-Press PN6

	1060058	32x2,9-32x3,0	25	1	pièce
---	----------------	---------------	----	---	-------

Uponor Wipex adaptateur S-Press PN6

	1060059	40x3,7-40x4,0	15	1	pièce
	1060060	50x4,6-50x4,5	10	1	pièce

Uponor Wipex pince écarteur

	1046407	1 - 1 ½	25	1	pièce
---	----------------	---------	----	---	-------

Uponor Q&E

N° art.	Dimension	UL	UE	unité
---------	-----------	----	----	-------

Uponor Q&E bague évolution white

 1057455	25		300	20 pièce
1057456	32		150	10 pièce

Uponor Q&E bague avec bord d'arrêt naturel

 1045464	40		80	5 pièce
1045489	50		70	5 pièce
1045490	63		35	5 pièce
1085087	75		18	2 pièce

Uponor Q&E coude PPSU

 1008681	25-25		25	5 pièce
1001245	32-32		10	1 pièce
1008683	40-40		10	1 pièce
1042859	50-50		5	1 pièce
1042858	63-63		3	1 pièce
1085080	75-75		2	1 pièce

Uponor Q&E manchon PPSU

 1008671	25-25		50	5 pièce
1001235	32-32		15	1 pièce
1008673	40-40		10	1 pièce
1042866	50-50		10	1 pièce
1042865	63-63		5	1 pièce
1085084	75-75		10	1 pièce

Uponor Q&E manchon réduit PPSU

 1001240	32-25		20	1 pièce
1008678	40-32		10	1 pièce
1042879	50-32		10	1 pièce
1042867	50-40		10	1 pièce
1042877	63-50		5	1 pièce
1085085	75-63		10	1 pièce

Uponor Q&E té PPSU

 1008686	25-25-25		20	5 pièce
1001250	32-32-32		10	1 pièce
1008688	40-40-40		5	1 pièce
1042861	50-50-50		3	1 pièce
1042860	63-63-63		2	1 pièce
1085081	75-75-75		2	1 pièce

N° art.	Dimension	UL	UE	unité
---------	-----------	----	----	-------

Uponor Q&E té réduit PPSU

 1008712	25-32-25		15	1 pièce
1001426	32-25-25		15	1 pièce
1001428	32-25-32		15	1 pièce
1008713	32-40-32		10	1 pièce
1008708	40-25-32		5	1 pièce
1008695	40-25-40		5	1 pièce
1008709	40-32-32		5	1 pièce
1008696	40-32-40		5	1 pièce
1042876	50-25-40		4	1 pièce
1042864	50-25-50		4	1 pièce
1042863	50-32-50		4	1 pièce
1042871	63-25-50		2	1 pièce
1042873	63-25-63		2	1 pièce
1042870	63-32-63		2	1 pièce
1085083	75-25-75		4	1 pièce

Uponor Q&E raccord mâle PL

 1023007	25-R¾"MT		70	5 pièce
1047191	32-R1"MT		10	1 pièce

Uponor Q&E raccord male PL/DR

 1085077	40-R1 ¼"MT		16	1 pièce
1085076	50-R1 ½"MT		8	1 pièce
1085075	63-R2"MT		6	1 pièce
1085074	75-R2 ½"MT		6	1 pièce

Uponor Q&E adapt. coudé filetage int. PL

 1023026	25-G¾"FT		35	5 pièce
--	----------	--	----	---------

Uponor Q&E raccord femelle PL

 1023012	25-Rp¾"FT		40	5 pièce
--	-----------	--	----	---------

Systeme de distribution Uponor Ecoflex

N° art.	Dimension	UL	UE	unité
---------	-----------	----	----	-------

Uponor Ecoflex embout terminal Single

 1018316	25+32+40/68	-	1	pièce
1018315	25+28+32/140	-	1	pièce
1018313	32+40+50/175	-	1	pièce
1018314	40+50+63/140	-	1	pièce
1095801	63+75+90/140	-	1	pièce
1018312	63+75/175	-	1	pièce
1018310	75+90+110/200	-	1	pièce
1018311	90+110/175	-	1	pièce
1067757	125/200	-	1	pièce

Uponor Ecoflex embout terminal Twin

 1119374	18-22+25-28+32/140	-	1	pièce
1018245	25+32+40/140	-	1	pièce
1018309	25+32+40/175	-	1	pièce
1018308	25+32+50/175	-	1	pièce
1018307	40+50+63/200	-	1	pièce
1088979	75+90/250	-	1	pièce

Uponor Ecoflex embout terminal Quattro

 1018306	18-22+25-28+32/175	-	1	pièce
---	--------------------	---	---	-------

Uponor Ecoflex kit d'isolation en T

 1060986	140/90/68	5	1	pièce
1060982	200/175/140	4	1	pièce
1121805	250/200/175/140	3	1	pièce

Uponor Ecoflex coude

 1060985	200/175/140	3	1	pièce
--	-------------	---	---	-------

Uponor Ecoflex manchon

 1060984	200/175/140	6	1	pièce
1121806	250	4	1	pièce

Uponor Ecoflex bague réduction

 1060991	200/68	8	1	pièce
1085107	200/160	12	1	pièce
1121807	250/250	-	1	pièce
1121808	250/200	-	1	pièce
1121809	250/175	-	1	pièce
1122070	250/140	-	-	pièce

Uponor Ecoflex kit isolé en H (té double)

 1007355	200/175/140	-	1	pièce
--	-------------	---	---	-------

N° art.	Dimension	UL	UE	unité
---------	-----------	----	----	-------

Uponor Ecoflex chambre

 1018326	6x140/175/200	3	1	pièce
1018327	8x140/175/200	3	1	pièce
1084576	2x250-6x140/175/200	1	1	pièce
1084577	4x250-4x140/175/200	1	1	pièce
1084578	6x250-2x140/175/200	1	1	pièce

Uponor Ecoflex bande trou d'inspection

 1018382	50mm x 10m	-	1	pièce
--	------------	---	---	-------

Uponor Ecoflex manchon rétractable

 1018379	140	-	1	pièce
1018380	175/200	-	1	pièce
1084575	250	15	1	pièce

Uponor Ecoflex coude de connexion Single

 1118767	75x6,8/140	-	1	pièce
---	------------	---	---	-------

Délai de livraison sur demande.

Uponor Ecoflex coude de connexion Twin

 1118771	2x25x2,3/140	-	1	pièce
1118772	2x32x2,9/140	-	1	pièce
1118773	2x40x3,7/160	-	1	pièce
1118774	2x50x4,6/200	-	1	pièce
1118775	2x63x5,8/200	-	1	pièce
1118776	2x75x6,8/250	-	1	pièce

Délai de livraison sur demande.

Uponor Ecoflex insert mural PWP

 1007358	68	-	1	pièce
1007360	140	-	1	pièce
1007361	175	-	1	pièce
1007362	200	-	1	pièce
1091429	250	-	1	pièce

Uponor Ecoflex insert pour traversée mur

 1007365	140	-	1	pièce
1007366	175	-	1	pièce
1007367	200	-	1	pièce
1091430	250	-	1	pièce

Système de distribution Uponor Ecoflex

N° art.	Dimension	UL	UE	unité
Uponor Ecoflex tube de coffrage ciment				
 1007368	68	-	1	pièce
1007370	140	-	1	pièce
1007371	175	-	1	pièce
1007372	200	-	1	pièce

Uponor Ecoflex kit résine époxy PWP				
 1007373	1,1 kg/3,5m ²	-	1	Kit



Uponor Ecoflex passage murale étanche				
 1018267	68+90	-	1	pièce
1018269	140	-	1	pièce
1018268	175+200	-	1	pièce
1083871	250	16	1	pièce

Uponor Ecoflex étanchéité labyrinthe NPW				
 1034202	140	40	1	pièce
1034203	175	30	1	pièce
1034204	200	20	1	pièce
1090415	250	-	1	pièce

Uponor Ecoflex kit de réparation				
 1036014	140+175+200-700mm	-	1	pièce

Uponor Ecoflex emballage rétractable				
 1093120	160mm x 10m	30	1	pièce

Uponor Ecoflex bande de repérage rouge				
 1018385	40mm x 250m	-	1	pièce
1105785	40mm x 30m	-	1	pièce

N° art.	Dimension	UL	UE	unité
Uponor Multi coupe-conduite				
 1089677	32-40	12	1	pièce
Uponor Multi lame coupe-conduite				
 1089779	32-40	50	1	pièce

Uponor Multi coupe-conduite				
 1089675	25-63	12	1	pièce

Uponor Multi lame coupe-conduite				
 1089777	25-63	50	1	pièce

Uponor Multi coupe-conduite				
 1089676	50-125	8	1	pièce

Uponor Multi lame coupe-conduite				
 1089778	50-125	50	1	pièce

Uponor MLC alésoir universel				
 1060167		50	1	pièce

Uponor Wipex pince écarteur				
 1046407	1 - 1 1/2	25	1	pièce

Uponor Q&E pâte graphite				
 1005017	100g	-	1	pièce

Uponor Ecoflex pâte d'étanchéité				
 1060996	290ml	-	1	pièce

Uponor Ecoflex ongles				
 1021997		-	1	pièce

Uponor Ecoflex jeu de vis				
 1021999		-	1	pièce

Uponor Ecoflex jeu de vis				
 1060995	M6x30 (34pcs)	-	1	pièce

Uponor Ecoflex Supra PLUS câble				
 1044136	10W/m	-	1	m

Outillages Uponor

N° art.	Dimension	UL	UE	unité
---------	-----------	----	----	-------

Uponor Dérouleur

Uponor MLC redresseur de tube



1010512	14-25	-	1	pièce
----------------	-------	---	---	-------

Uponor Multi dérouleur telescope



1058662		-	1	pièce
----------------	--	---	---	-------

Uponor Multi dérouleur



1006255	120-960m	-	1	pièce
----------------	----------	---	---	-------

Uponor Magna dérouleur



1006256	25-640m	-	1	pièce
----------------	---------	---	---	-------

Uponor Magna dérouleur



1135500		18	1	pièce
----------------	--	----	---	-------

N° art.	Dimension	UL	UE	unité
---------	-----------	----	----	-------

Uponor Découpe & préparation

Uponor Multi coupe-tube, coupe-conduite



1089674	12-25	36	1	pièce
----------------	-------	----	---	-------

Uponor Multi lame coupe-conduite



1089776	12-25	150	1	pièce
----------------	-------	-----	---	-------

Uponor Multi coupe-conduite



1089677	32-40	12	1	pièce
----------------	-------	----	---	-------

Uponor Multi lame coupe-conduite



1089779	32-40	50	1	pièce
----------------	-------	----	---	-------

Uponor Multi coupe-conduite



1089675	25-63	12	1	pièce
----------------	-------	----	---	-------

Uponor Multi lame coupe-conduite



1089777	25-63	50	1	pièce
----------------	-------	----	---	-------

Uponor Multi coupe-conduite



1089676	50-125	8	1	pièce
----------------	--------	---	---	-------

Uponor Multi lame coupe-conduite



1089778	50-125	50	1	pièce
----------------	--------	----	---	-------

Uponor Flex coupe-tube PEX



1089673	12-25	36	1	pièce
----------------	-------	----	---	-------

Uponor Flex lame pour coupe-tube PEX



1089780	12-25	150	1	pièce
----------------	-------	-----	---	-------

Uponor MLC mallette outillage



1014334	63-110	-	1	pièce
----------------	--------	---	---	-------

Uponor MLC lame pour coupe tube



1006635	25-63	-	1	pièce
----------------	-------	---	---	-------

1014173	50-110	20	1	pièce
----------------	--------	----	---	-------

Uponor MLC disque de rechange



1014320	63-110	-	1	pièce
----------------	--------	---	---	-------

Outillages Uponor

N° art. Dimension UL UE unité

Uponor Découpe & préparation

Uponor MLC ébavureuse

	1006952	14	50	1	pièce
	1006830	16	50	1	pièce
	1015749	20	1200	1	pièce
	1015756	25	960	1	pièce
	1015762	32	900	1	pièce

Uponor MLC appareil de chanfreinage

	1006638	40	600	1	pièce
	1015808	50	600	1	pièce
	1014339	63	600	1	pièce
	1014344	75	600	1	pièce

Uponor MLC ébavureuse

	1015739	16/20/25	60	1	pièce
---	----------------	----------	----	---	-------

Uponor MLC alésoir universel

	1060167		50	1	pièce
---	----------------	--	----	---	-------

N° art. Dimension UL UE unité

Uponor MLC ressort intérieur

	1013727	14		1000	1	pièce
	1013729	16		100	1	pièce
	1013734	20		75	1	pièce
	1013737	25		50	1	pièce
	1013739	32		40	1	pièce

Uponor MLC ressort extérieur

	1006639	14		550	1	pièce
	1006640	16		55	1	pièce
	1013792	20		45	1	pièce
	1013794	25		45	1	pièce

Uponor Uni Pipe PLUS cintreuse

	1071925	16-32		100	1	pièce
--	----------------	-------	--	-----	---	-------

Uponor Uni Pipe PLUS Segment de flexion

	1120408	R32 16		10	1	pièce
	1120409	R40 20		10	1	pièce
	1120410	R62,5 25		10	1	pièce
	1120411	R80 32		10	1	pièce

Uponor RTM calibreur

	1048606	16/20/25		20	1	pièce
---	----------------	----------	--	----	---	-------

Outillages Uponor

N° art.	Dimension	UL	UE	unité
---------	-----------	----	----	-------

Outillages de sertissage

Uponor S-Press pince man. sans insert

	1015764	14-20	100	1	pièce
---	----------------	-------	-----	---	-------

Uponor S-Press insert pince manuelle

	1015776	14	400	1	pièce
	1015777	16	50	1	pièce
	1015780	20	50	1	pièce

Uponor S-Press sertisseuse manuelle BENELUX

	1013778	14-20	20	1	pièce
---	----------------	-------	----	---	-------

Uponor S-Press outils UP110 sans mâch.

	1083612		20	1	Kit
--	----------------	--	----	---	-----

Uponor S-Press batterie UP110

	1083608		10	1	pièce
---	----------------	--	----	---	-------

Uponor S-Press chargeur batterie

	1083610	Mini2, UP110	-	1	pièce
---	----------------	--------------	---	---	-------

Uponor S-Press machine à sertir élect. UP75 EL

	1007082		20	1	pièce
---	----------------	--	----	---	-------

Uponor S-Press mâchoire UPP1

	1007083	14	280	1	pièce
	1007084	16	216	1	pièce
	1007086	20	-	1	pièce
	1007087	25	-	1	pièce
	1007088	32	-	1	pièce
	1015768	40	108	1	pièce
	1015792	50	108	1	pièce

N° art.	Dimension	UL	UE	unité
---------	-----------	----	----	-------

Uponor S-Press mâchoire de base

	1046545	63-110	-	1	pièce
---	----------------	--------	---	---	-------

Uponor S-Press extension de mâchoire

	1046541	63	72	1	pièce
	1046542	75	72	1	pièce
	1046543	90	72	1	pièce
	1046544	110	54	1	pièce

Uponor S-Press outil Mini² mâchoire KSP0

	1083586	16/20/25/32	30	1	Kit
---	----------------	-------------	----	---	-----

Uponor S-Press outil Mini² mâch. KSP0

	1083594	16/20/25	25	1	Kit
---	----------------	----------	----	---	-----

Uponor S-Press batterie Mini²

	1083605		-	1	pièce
---	----------------	--	---	---	-------

Uponor S-Press mâchoire Mini KSP0

	1007090	14	5	1	pièce
	1007091	16	5	1	pièce
	1007093	20	5	1	pièce
	1007094	25	5	1	pièce
	1007095	32	5	1	pièce

Uponor S-Press jeu d'outillage BENELUX

	1083584	16/20/25	-	1	Kit
	1083585	16/20/25/32	-	1	Kit

Outillages Uponor

N° art.	Dimension	UL	UE	unité
---------	-----------	----	----	-------

Outillages d'expansion

Uponor Minitec outil d'expansion



1006247	9,9x1,1		11	1	Kit
---------	---------	--	----	---	-----

Uponor Q&E outil d'évasement avec évasement c. M12/



1119379	16RS/20/25 10bar	-		1	Kit
1119376	16RS/20/25 6bar	-		1	Kit
1119375	6bar 9,9RS/20	-		1	Kit

Uponor Q&E tête d'expansion M12/Rapid Seal



1119380	9,9x1,1	-		1	pièce
---------	---------	---	--	---	-------

Uponor Q&E tête d'expansion M12/M18



1057171	12x1,1/1,7/1,8/2,0	-		1	pièce
1057184	14/15x2,5	-		1	pièce
1057185	17/18x2,5	-		1	pièce

Uponor Q&E tête d'expansion M12/M18/Rapid Seal



1119381	16x1,8/2,0/2,2	-		1	pièce
1119382	20x1,9/2,0	-		1	pièce
1119383	20x2,8	-		1	pièce
1119384	25x2,3	-		1	pièce
1119385	25x3,5	-		1	pièce
1119386	32x2,9	-		1	pièce

Uponor Q&E accu rempl. outil d'exp. M12



1061185	4Ah		12	1	pièce
---------	-----	--	----	---	-------

N° art.	Dimension	UL	UE	unité
---------	-----------	----	----	-------

Uponor Q&E outil d'expansion avec tête M18 6bar



1063908	16/20/25/32	-		1	Kit
---------	-------------	---	--	---	-----

Uponor Q&E outil d'expansion avec tête M18 10bar



1063909	16/20/25/H32	-		1	Kit
---------	--------------	---	--	---	-----

Uponor Q&E tête d'expansion M18 H



1057182	32x2,9/4,4	-		1	pièce
1057183	40x3,7	-		1	pièce

Uponor Q&E outil d'expansion M18 VLD PEX



1085099	40-75	-		1	pièce
---------	-------	---	--	---	-------

Uponor Q&E tête d'expansion VLD



1085095	40x3,7/5,5	-		1	pièce
1085096	50x4,6/6,9	-		1	pièce
1085097	63x5,8/8,6	-		1	pièce
1085098	75x6,8/10,3	-		1	pièce

Uponor Q&E batterie outil expansion M18 PEX



1085100	5,0Ah	-		1	pièce
---------	-------	---	--	---	-------

Uponor Q&E chargeur outil expansion M12/M18 PEX



1085101	220-240V/50-60Hz	-		1	pièce
---------	------------------	---	--	---	-------

Uponor Q&E pâte graphite



1005017	100g	-		1	pièce
---------	------	---	--	---	-------

Outillages Uponor

N° art. Dimension UL UE unité

Uponor fixation

Uponor Multi support de tube



1088066		-	1	pièce
----------------	--	---	---	-------

Uponor Siccus 14 cutter à polystyrène



1006290	14mm 230V	-	1	pièce
----------------	-----------	---	---	-------

Uponor Tacker outil



1119039	14-20mm	50	1	pièce
----------------	---------	----	---	-------

Uponor Classic



1006295	16/17mm l=920mm	100	1	pièce
----------------	-----------------	-----	---	-------

1006309	20mm l=920mm	-	1	pièce
----------------	--------------	---	---	-------

Uponor Classic outil tordage



1006243	l=320mm	50	1	pièce
----------------	---------	----	---	-------

N° art. Dimension UL UE unité

Uponor autres

Uponor Rapex tête à sertir



1006330	14x2	-	1	pièce
----------------	------	---	---	-------

1006332	16x2	8	1	pièce
----------------	------	---	---	-------

1006343	17x2	-	1	pièce
----------------	------	---	---	-------

Uponor Smart Aqua sup. de mont. outil de cintr.



1015424	2m	-	1	pièce
----------------	----	---	---	-------

Télécharger la liste de prix en ligne complète:



Directement vers le téléchargement de la liste de prix complète Benelux 2024 (uniquement disponible en version PDF).

- Pour plus d'informations, veuillez consulter les sites web www.uponor.nl / www.nathan.nl ou www.uponor.be / www.nathan.be

Toutes les informations légales et techniques ont été compilées avec le plus grand soin possible. Les erreurs ne peuvent cependant pas être totalement exclues et aucune responsabilité ne sera acceptée à cet égard. Tous les éléments de ce document sont protégés par des droits d'auteur. Toute utilisation sauf exceptions autorisées par les droits d'auteur, sans l'autorisation d'Uponor GmbH est interdite. Sous réserve de modifications techniques.

Moving > Water

Uponor

Uponor GmbH

Industriestraße 56

97437 Hassfurt

Germany

www.uponor.com



Nathan Systems NV/SA

Lozenberg 4

1932 Zaventem

België

T +32 (0)2 721 15 70

F +32 (0)2 725 35 53

W www.nathan.be

E info@nathan.be

W www.uponor.be

E info.be@uponor.com

Nathan Systems BV

Mega 2

6902 KL, Zevenaar

Nederland

T +31 (0)26-445 98 45

F +31 (0)26-445 93 73

W www.nathan.nl

E info@nathan.nl

W www.uponor.nl

E info.nl@uponor.com