

# Data Sheet | Item Number: 769-151

4-pin carrier terminal block; for DIN-rail 35 x 15 and 35 x 7.5; gray

<https://www.wago.com/769-151>

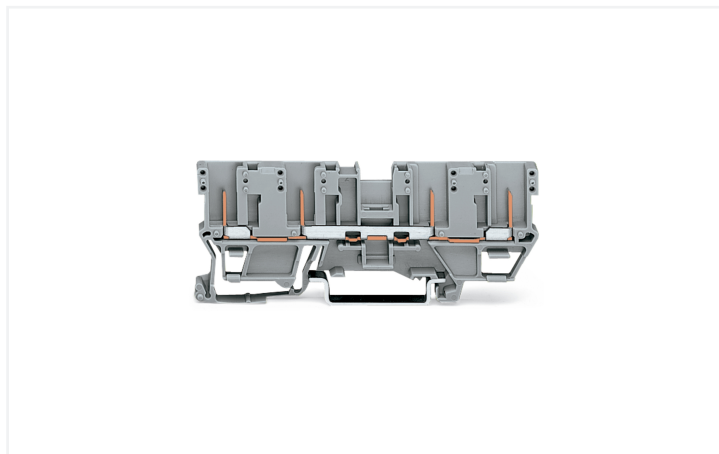
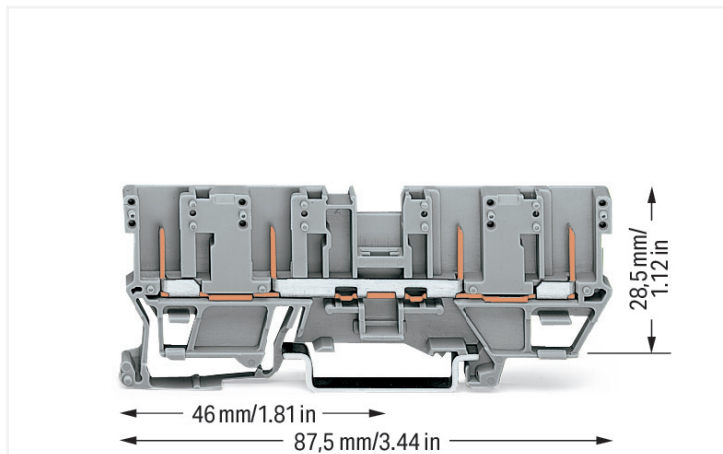

Color: ■ gray

Through terminal block, 769 Series, gray

This through terminal block (item number 769-151) is designed for easy and secure connections. Whether for use in industry or building installations, our rail-mount through terminal blocks allow you to quickly and securely connect electrical conductors. They're perfect for either classic through-wiring or distributing potential, depending on the variant.

Notes	
Safety Information	A separator plate (Item No. 209-191) or a 10 mm end stop (Item No. 249-117) must be placed at the end of a WAGO X-COM®-SYSTEM terminal strip.
Safety information 2	Staggered jumpers cannot be installed in terminal blocks when using 2-conductor female plugs.
Note	1-conductor angled female plugs cannot be used.

Electrical data				
Ratings per	IEC/EN 60947-7-1			Power Loss
Overvoltage category	III	III	II	Rated current $I_N$ for power loss specification 32 A
Pollution degree	3	2	2	
Nominal voltage	500 V	-	-	
Rated impulse withstand voltage	6 kV	-	-	
Rated current	32 A	-	-	

General information	
Wiring direction	Front-entry wiring

### Connection Data

Total number of potentials	1	<b>Connection 1</b>	
Number of levels	1	Wiring direction	Front-entry wiring

### Physical data

Width	5 mm / 0.197 inches
Height	87.5 mm / 3.445 inches
Depth from upper-edge of DIN-rail	28.5 mm / 1.122 inches

### Mechanical data

Design	horizontal type
Mounting type	DIN-35 rail
Marking level	Center marking

### Material data

Note (material data)	<a href="#">Information on material specifications can be found here</a>
Color	gray
Material group	I
Insulation material (main housing)	Polyamide (PA66)
Flammability class per UL94	V0
Fire load	0.16 MJ
Weight	8.6 g

### Environmental requirements

Processing temperature	-35 ... +85 °C
Continuous operating temperature	-60 ... +105 °C

### Commercial data

Product Group	18 (X-COM-System)
PU (SPU)	50 pcs
Packaging type	Box
Country of origin	DE
GTIN	4044918542456
Customs tariff number	85366990990

### Product Classification

UNSPSC	39121410
eCl@ss 10.0	27-14-11-20
eCl@ss 9.0	27-14-11-20
ETIM 9.0	EC000897
ETIM 10.0	EC000897
ECCN	NO US CLASSIFICATION

Environmental Product Compliance	
RoHS Compliance Status	Compliant, No Exemption

### Approvals / Certificates

#### General approvals



Approval	Standard	Certificate Name
CCA DEKRA Certification B.V.	EN 60947	NTR NL-7626
CSA CSA Group	C22.2	1101144
KEMA/KEUR DEKRA Certification B.V.	EN 60947	2190419.01
UL Underwriters Laboratories Inc.	UL 1059	E45172
UL Underwriters Laboratories Inc.	UL 1977	E 45171

#### Declarations of conformity and manufacturer's declarations



Approval	Standard	Certificate Name
EU-Declaration of Conformity WAGO GmbH & Co. KG	-	-
Railway WAGO GmbH & Co. KG	-	Z00004428.000

#### Approvals for marine applications



Approval	Standard	Certificate Name
ABS American Bureau of Shipping	EN 60947	24-0152298-PDA
BV Bureau Veritas S.A.	EN 60947	07436/G0 BV
DNV GL Det Norske Veritas, Germanischer Lloyd	-	TAE00001V2
PRS Polski Rejestr Statków	-	TE/1094/880590/23

### Downloads

#### Environmental Product Compliance

Compliance Search
Environmental Product Compliance 769-151

Documentation

Bid Text			
769-151	19.02.2019	xml 2.93 KB	
769-151	02.10.2017	doc 24.00 KB	

CAD/CAE-Data

CAD data	CAE data
2D/3D Models 769-151	EPLAN Data Portal 769-151
	WSCAD Universe 769-151
	ZUKEN Portal 769-151

1 Compatible Products

1.1 System counterpart

1.1.1 Female connector/socket

 <b>Item No.: 769-110/145-000</b> 1-conductor female connector; CAGE CLAMP®; 4 mm²; Pin spacing 5 mm; 10-pole; coding finger; Centered locking levers; Strain relief plate; 4,00 mm²; gray	 <b>Item No.: 769-111/145-000</b> 1-conductor female connector; CAGE CLAMP®; 4 mm²; Pin spacing 5 mm; 11-pole; coding finger; Centered locking levers; Strain relief plate; 4,00 mm²; gray	 <b>Item No.: 769-112/145-000</b> 1-conductor female connector; CAGE CLAMP®; 4 mm²; Pin spacing 5 mm; 12-pole; coding finger; Centered locking levers; Strain relief plate; 4,00 mm²; gray	 <b>Item No.: 769-113/145-000</b> 1-conductor female connector; CAGE CLAMP®; 4 mm²; Pin spacing 5 mm; 13-pole; coding finger; Centered locking levers; Strain relief plate; 4,00 mm²; gray
 <b>Item No.: 769-114/145-000</b> 1-conductor female connector; CAGE CLAMP®; 4 mm²; Pin spacing 5 mm; 14-pole; coding finger; Centered locking levers; Strain relief plate; 4,00 mm²; gray	 <b>Item No.: 769-115/145-000</b> 1-conductor female connector; CAGE CLAMP®; 4 mm²; Pin spacing 5 mm; 15-pole; coding finger; Centered locking levers; Strain relief plate; 4,00 mm²; gray	 <b>Item No.: 769-101</b> 1-conductor female connector; CAGE CLAMP®; 4 mm²; Pin spacing 5 mm; 1-pole; coding finger; 4,00 mm²; gray	 <b>Item No.: 769-101/141-000</b> 1-conductor female connector; CAGE CLAMP®; 4 mm²; Pin spacing 5 mm; 1-pole; coding finger; Centered locking levers; Strain relief plate; 4,00 mm²; gray
 <b>Item No.: 769-102/142-000</b> 1-conductor female connector; CAGE CLAMP®; 4 mm²; Pin spacing 5 mm; 2-pole; coding finger; Centered locking levers; Strain relief plate; 4,00 mm²; gray	 <b>Item No.: 769-103/142-000</b> 1-conductor female connector; CAGE CLAMP®; 4 mm²; Pin spacing 5 mm; 3-pole; coding finger; Centered locking levers; Strain relief plate; 4,00 mm²; gray	 <b>Item No.: 769-104/143-000</b> 1-conductor female connector; CAGE CLAMP®; 4 mm²; Pin spacing 5 mm; 4-pole; coding finger; Centered locking levers; Strain relief plate; 4,00 mm²; gray	 <b>Item No.: 769-105/143-000</b> 1-conductor female connector; CAGE CLAMP®; 4 mm²; Pin spacing 5 mm; 5-pole; coding finger; Centered locking levers; Strain relief plate; 4,00 mm²; gray
 <b>Item No.: 769-106/144-000</b> 1-conductor female connector; CAGE CLAMP®; 4 mm²; Pin spacing 5 mm; 6-pole; coding finger; Centered locking levers; Strain relief plate; 4,00 mm²; gray	 <b>Item No.: 769-107/144-000</b> 1-conductor female connector; CAGE CLAMP®; 4 mm²; Pin spacing 5 mm; 7-pole; coding finger; Centered locking levers; Strain relief plate; 4,00 mm²; gray	 <b>Item No.: 769-108/144-000</b> 1-conductor female connector; CAGE CLAMP®; 4 mm²; Pin spacing 5 mm; 8-pole; coding finger; Centered locking levers; Strain relief plate; 4,00 mm²; gray	 <b>Item No.: 769-109/144-000</b> 1-conductor female connector; CAGE CLAMP®; 4 mm²; Pin spacing 5 mm; 9-pole; coding finger; Centered locking levers; Strain relief plate; 4,00 mm²; gray
 <b>Item No.: 769-121</b> 2-conductor female connector; CAGE CLAMP®; 4 mm²; Pin spacing 5 mm; 1-pole; coding finger; 4,00 mm²; gray			

## 1.2 Required Accessories

### 1.2.1 End plate

#### 1.2.1.1 End plate



**Item No.: 769-301**

End and intermediate plate; 1.1 mm thick; gray

**Item No.: 769-302**

End and intermediate plate; 1.1 mm thick; orange

## 1.3 Optional Accessories

### 1.3.1 Coding

#### 1.3.1.1 Coding



**Item No.: 769-435**

Coding pin; for coding of female plugs; for carrier terminal blocks / male connectors; orange

### 1.3.2 Cover

#### 1.3.2.1 Cover



**Item No.: 769-438**

Pin cover; with marker slot for miniature WSB; gray

**Item No.: 769-439**

Pin cover; with marker slot for miniature WSB; orange

### 1.3.3 DIN-rail

#### 1.3.3.1 Mounting accessories



**Item No.: 210-196**

Aluminum carrier rail; 35 x 8.2 mm; 1.6 mm thick; 2 m long; unslotted; similar to EN 60715; silver-colored



**Item No.: 210-198**

Copper carrier rail; 35 x 15 mm; 2.3 mm thick; 2 m long; unslotted; according to EN 60715; copper-colored



**Item No.: 210-508**

Steel carrier rail; 35 x 15 mm; 1.5 mm thick; 2 m long; slotted; galvanized; similar to EN 60715; silver-colored



**Item No.: 210-197**

Steel carrier rail; 35 x 15 mm; 1.5 mm thick; 2 m long; slotted; similar to EN 60715; silver-colored



**Item No.: 210-506**

Steel carrier rail; 35 x 15 mm; 1.5 mm thick; 2 m long; unslotted; galvanized; similar to EN 60715; silver-colored



**Item No.: 210-114**

Steel carrier rail; 35 x 15 mm; 1.5 mm thick; 2 m long; unslotted; similar to EN 60715; silver-colored



**Item No.: 210-118**

Steel carrier rail; 35 x 15 mm; 2.3 mm thick; 2 m long; unslotted; according to EN 60715; silver-colored



**Item No.: 210-115**

Steel carrier rail; 35 x 7.5 mm; 1 mm thick; 2 m long; slotted; according to EN 60715; "Hole width 18 mm; silver-colored



**Item No.: 210-112**

Steel carrier rail; 35 x 7.5 mm; 1 mm thick; 2 m long; slotted; according to EN 60715; "Hole width 25 mm; silver-colored



**Item No.: 210-504**

Steel carrier rail; 35 x 7.5 mm; 1 mm thick; 2 m long; slotted; galvanized; according to EN 60715; silver-colored



**Item No.: 210-113**

Steel carrier rail; 35 x 7.5 mm; 1 mm thick; 2 m long; unslotted; according to EN 60715; silver-colored



**Item No.: 210-505**

Steel carrier rail; 35 x 7.5 mm; 1 mm thick; 2 m long; unslotted; galvanized; according to EN 60715; silver-colored

### 1.3.4 Installation

#### 1.3.4.1 Mounting accessories



**Item No.: 209-106**

Mounting carrier; for isolated mounting on DIN 35 rails; gray

**Item No.: 249-116**

Screwless end stop; 6 mm wide; for DIN-rail 35 x 15 and 35 x 7.5; gray

### 1.3.5 Jumper

#### 1.3.5.1 Jumper



**Item No.: 280-402**

Jumper; insulated; gray



**Item No.: 280-409**

Jumper; insulated; gray



**Item No.: 780-452**

Staggered jumper; from 1 to 2; insulated; gray



**Item No.: 780-453**

Staggered jumper; from 1 to 3; insulated; gray



**Item No.: 780-454**

Staggered jumper; from 1 to 4; insulated; gray



**Item No.: 780-455**

Staggered jumper; from 1 to 5; insulated; gray



**Item No.: 780-456**

Staggered jumper; from 1 to 6; insulated; gray



**Item No.: 780-457**

Staggered jumper; from 1 to 7; insulated; gray



**Item No.: 780-458**

Staggered jumper; from 1 to 8; insulated; gray

### 1.3.6 Marking

#### 1.3.6.1 Marker



**Item No.: 2009-145**

Mini-WSB In-line; for Smart Printer; 1700 pieces on roll; stretchable 5 - 5.2 mm; plain; snap-on type; white



**Item No.: 248-501**

Mini-WSB marking card; as card; not stretchable; plain; snap-on type; white

### 1.3.7 Push-in type wire jumper

#### 1.3.7.1 Jumper



**Item No.: 249-126**

Push-in type wire jumper; 0.75 mm<sup>2</sup>; insulated; 110 mm long; black



**Item No.: 249-123**

Push-in type wire jumper; 0.75 mm<sup>2</sup>; insulated; 180 mm long; black



**Item No.: 249-127**

Push-in type wire jumper; 0.75 mm<sup>2</sup>; insulated; 250 mm long; black



**Item No.: 249-125**

Push-in type wire jumper; insulated; 60 mm long; black

### 1.3.8 Test and measurement

#### 1.3.8.1 Testing accessories



**Item No.: 280-419**

Spacer module; modular; bridging commoned terminal blocks; gray



**Item No.: 280-404**

Test plug adapter; 5 mm wide; for test plug (2.3 mm Ø); suitable for 1.5 mm<sup>2</sup> - 4 mm<sup>2</sup> tbs; gray



**Item No.: 280-418**

Test plug module; modular; suitable for all WAGO 280 and 780 Series rail-mounted terminal blocks with jumper slots in the current bar; gray

### 1.3.9 Tool

#### 1.3.9.1 Operating tool



**Item No.: 210-720**

Operating tool; Blade: 3.5 x 0.5 mm; with a partially insulated shaft; multicoloured

## Installation Notes

### Installation

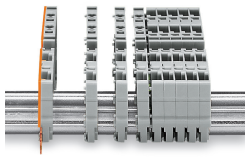

Snap individual carrier terminal blocks onto the DIN-rail and slide together.

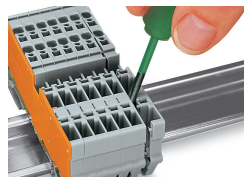

Open the assembly by laterally sliding a block via operating tool and remove terminal block via release lever.

## Commoning

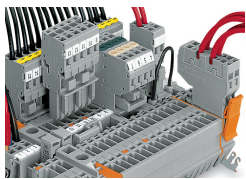

Commoning with adjacent or staggered jumpers. Push jumpers down until fully inserted.

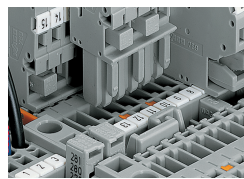

Commoning carrier terminal blocks via staggered jumpers.

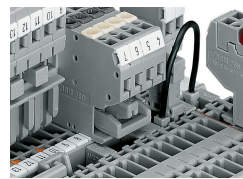

Commoning a 2-conductor female plug via staggered jumper and carrier terminal blocks via adjacent jumpers.

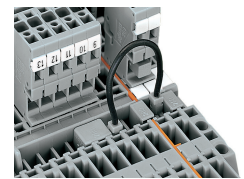

Commoning carrier terminal blocks via push-in type wire jumpers or adjacent jumpers – even over an intermediate plate.

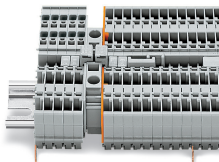

Commoning "supply terminal blocks" (up to 10 mm<sup>2</sup>/8 AWG) with carrier terminal blocks via step-down jumpers.

Coding

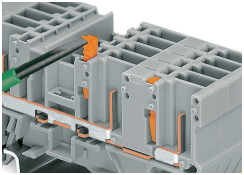

Snap coding pin in proper direction on carrier terminal block.  
Shown: Coding pin removal from carrier terminal block.

Locking system

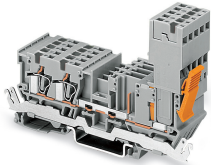

Securing a female plug via locking lever on the terminal block side.

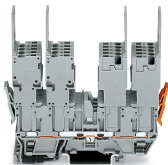
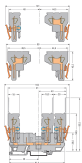

4 x 1-conductor female plugs  
Carrier terminal blocks can be commoned via 280 and 780 Series Jumpers and tested using a test plug adapter (280-4..).

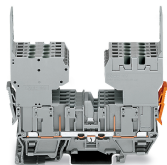

2 x 2-conductor female plugs  
Carrier terminal blocks can be commoned via 280 and 780 Series Jumpers and tested using a test plug adapter (280-4..).

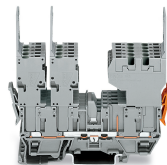

2 x 1-conductor female plug (left), 1 x 2-conductor female plug (right), may be reversed – carrier terminal blocks can be commoned via 280 and 780 Series Jumpers and tested using a test plug adapter (280-4..).

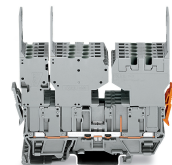

1-conductor and 2-conductor female plugs (left), 2-conductor female plug (right), may be reversed – carrier terminal blocks can only be commoned via 280 Series Adjacent and Alternate Jumpers.

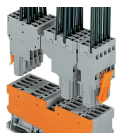

4-pin carrier terminal block  
2-conductor female plug  
1-conductor female plug, straight