

Data Sheet | Item Number: 280-621

4-conductor through terminal block; 2.5 mm²; lateral marker slots; for DIN-rail 35 x 15 and 35 x 7.5; CAGE CLAMP®; 2,50 mm²; gray

<https://www.wago.com/280-621>

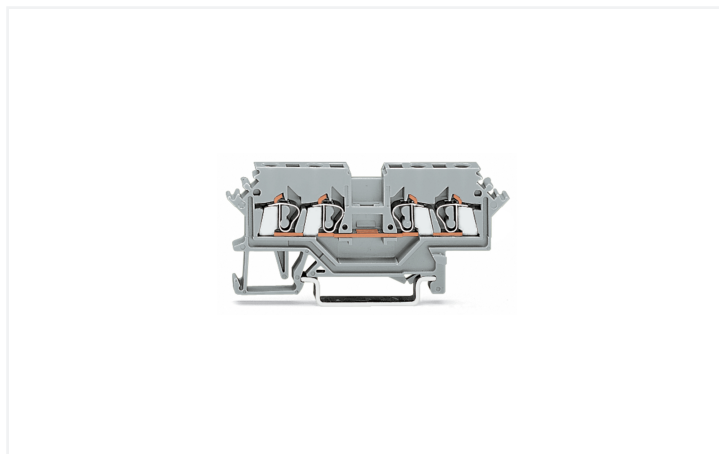
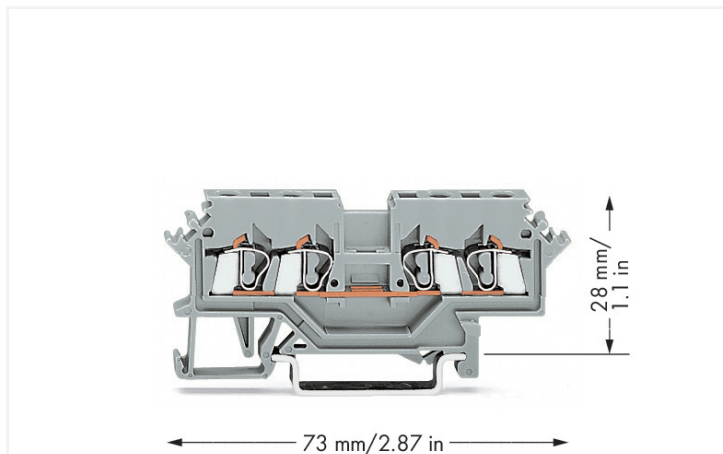

Color: ■ gray

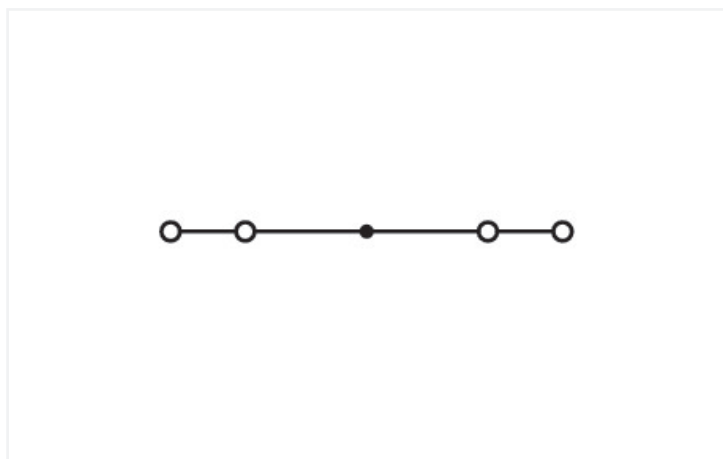

Similar to illustration

Through terminal block, 280 Series, gray

Our through terminal block (item number 280-621) is designed for seamless electrical installations. Conductors can only be connected to this through terminal block if their strip length is between 8 and 9 mm. Whether in industrial or building applications, our rail-mount through terminal blocks are the perfect solution to quickly and securely connect electrical conductors. Depending on the model, you can use them for either typical through-wiring or potential distribution. This product features conductor terminals and utilizes CAGE CLAMP®. Our CAGE CLAMP® connection offers a reliable and maintenance-free way to connect all types of conductors. You do not need to prepare the conductor in any way, such as crimping ferrules. This through terminal block is suitable for conductor cross sections ranging from 0.08 mm² to 2.5 mm².

This through rail-mount terminal block is operated with an operating tool.

Electrical data

| Ratings per | IEC/EN 60947-7-1 | | |
|---------------------------------|------------------|-----|----|
| Overvoltage category | III | III | II |
| Pollution degree | 3 | 2 | 2 |
| Nominal voltage | 800 V | - | - |
| Rated impulse withstand voltage | 8 kV | - | - |
| Rated current | 24 A | - | - |

| Approvals per | UL 1059 | | |
|---------------|---------|-------|---|
| Use group | B | C | D |
| Rated voltage | - | 600 V | - |
| Rated current | - | 20 A | - |

| Approvals per | CSA 22.2 No 158 | | |
|---------------|-----------------|-------|---|
| Use group | B | C | D |
| Rated voltage | - | 600 V | - |
| Rated current | - | 24 A | - |

| Power Loss | |
|--|------------------|
| Power loss, per pole (potential) | 0.7661 W |
| Rated current I_N for power loss specification | 24 A |
| Resistance value for specified, current-dependent power loss | 0.00133 Ω |

General information

| | |
|------------------|--------------------|
| Wiring direction | Front-entry wiring |
|------------------|--------------------|

Connection Data

| | |
|----------------------------|---|
| Clamping units | 4 |
| Total number of potentials | 1 |
| Number of levels | 1 |

| Connection 1 | |
|--|---|
| Connection technology | CAGE CLAMP® |
| Actuation type | Operating tool |
| Connectable conductor materials | Copper Aluminum |
| Connectable conductor materials (note) | <p>Terminating Aluminum Conductors WAGO Spring-Clamp Terminal Blocks are suitable for solid aluminum conductors up to 4 mm²/12 AWG if WAGO "Alu-Plus" Contact Paste 249-130 is used for termination.</p> <p>"Alu-Plus" Contact Paste Advantages:</p> <ul style="list-style-type: none"> • Automatically destroys the oxide film during clamping. • Prevents fresh oxidation at the clamping point. • Prevents electrolytic corrosion between aluminum and copper conductors (in the same terminal block). • Provides long-term protection against corrosion. <p>Using terminal blocks with CAGE CLAMP® Spring Pressure Connection Technology, aluminum conductors must first be cleaned with a blade and then immediately inserted into the clamping units filled with "Alu-Plus" contact paste.</p> <p>It is also possible to apply WAGO "Alu-Plus" additionally on the whole surface of the aluminum conductor before termination.</p> <p>Please note that the nominal currents must be adapted to the reduced conductivity of the aluminum conductors: 2.5 mm² = 16 A 4 mm² = 22 A</p> |
| Solid conductor | 0.08 ... 2.5 mm ² / 28 ... 12 AWG |
| Fine-stranded conductor | 0.08 ... 2.5 mm ² / 28 ... 12 AWG |
| Note (conductor cross-section) | 12 AWG: THHN, THWN |
| Strip length | 8 ... 9 mm / 0,31 ... 0,35 inches |
| Wiring direction | Front-entry wiring |

Physical data

| | |
|-----------------------------------|----------------------|
| Width | 5 mm / 0.197 inches |
| Height | 73 mm / 2.874 inches |
| Depth from upper-edge of DIN-rail | 28 mm / 1.102 inches |

Mechanical data

| | |
|---------------|--------------|
| Mounting type | DIN-35 rail |
| Marking level | Side marking |

Material data

| | |
|------------------------------------|--|
| Note (material data) | Information on material specifications can be found here |
| Color | gray |
| Material group | I |
| Insulation material (main housing) | Polyamide (PA66) |
| Flammability class per UL94 | V0 |
| Fire load | 0.135 MJ |
| Weight | 8.2 g |

Environmental requirements

| | |
|----------------------------------|-----------------|
| Processing temperature | -35 ... +85 °C |
| Continuous operating temperature | -60 ... +105 °C |

Commercial data

| | |
|-----------------------|---------------|
| PU (SPU) | 100 pcs |
| Packaging type | Box |
| Country of origin | DE |
| GTIN | 4044918391092 |
| Customs tariff number | 85369010000 |

Product Classification

| | |
|-------------|----------------------|
| UNSPSC | 39121410 |
| eCl@ss 10.0 | 27-14-11-20 |
| eCl@ss 9.0 | 27-14-11-20 |
| ETIM 9.0 | EC000897 |
| ETIM 10.0 | EC000897 |
| ECCN | NO US CLASSIFICATION |

Environmental Product Compliance

| | |
|------------------------|-------------------------|
| RoHS Compliance Status | Compliant, No Exemption |
|------------------------|-------------------------|

Approvals / Certificates

General approvals



| Approval | Standard | Certificate Name |
|---------------------------------------|----------|------------------|
| CSA DEKRA Certification B.V. | C22.2 | 1536071 |
| KEMA/KEUR DEKRA Certification B.V. | EN 60947 | 71-154769 |
| UL Underwriters Laboratories Inc. | UL 1059 | E45172 |

Declarations of conformity and manufacturer's declarations

| Approval | Standard | Certificate Name |
|---|----------|------------------|
| EU-Declaration of Confor- mity WAGO GmbH & Co. KG | - | - |
| UK-Declaration of Confor- mity WAGO GmbH & Co. KG | - | - |

Approvals for marine applications



| Approval | Standard | Certificate Name |
|---|----------|------------------|
| ABS American Bureau of Ship- ping | EN 60947 | 24-0152298-PDA |
| BV Bureau Veritas S.A. | EN 60947 | 07436/G0 BV |
| DNV GL Det Norske Veritas, Ger- manischer Lloyd | - | TAE00001V2 |

Downloads

Environmental Product Compliance

| Compliance Search |
|---|
| Environmental Product Compliance 280-621 ↓ |

CAD/CAE-Data

| CAD data |
|--|
| 2D/3D Models 280-621 ↓ |

| CAE data |
|--|
| EPLAN Data Portal 280-621 ↓ |
| WSCAD Universe 280-621 ↓ |
| ZUKEN Portal 280-621 ↓ |

1 Compatible Products

1.1 Required Accessories

1.1.1 End plate

1.1.1.1 End plate



Item No.: 280-316
End and intermediate plate; 2.5 mm thick; gray



Item No.: 280-317
End and intermediate plate; 2.5 mm thick; orange



Item No.: 280-337
Separator plate; 2 mm thick; oversized; gray



Item No.: 280-327
Separator plate; 2 mm thick; oversized; orange

1.2 Optional Accessories

1.2.1 DIN-rail

1.2.1.1 Mounting accessories



Item No.: 210-196
Aluminum carrier rail; 35 x 8.2 mm; 1.6 mm thick; 2 m long; unslotted; similar to EN 60715; silver-colored



Item No.: 210-198
Copper carrier rail; 35 x 15 mm; 2.3 mm thick; 2 m long; unslotted; according to EN 60715; copper-colored



Item No.: 210-508
Steel carrier rail; 35 x 15 mm; 1.5 mm thick; 2 m long; slotted; galvanized; similar to EN 60715; silver-colored



Item No.: 210-197
Steel carrier rail; 35 x 15 mm; 1.5 mm thick; 2 m long; slotted; similar to EN 60715; silver-colored



Item No.: 210-506
Steel carrier rail; 35 x 15 mm; 1.5 mm thick; 2 m long; unslotted; galvanized; similar to EN 60715; silver-colored



Item No.: 210-114
Steel carrier rail; 35 x 15 mm; 1.5 mm thick; 2 m long; unslotted; similar to EN 60715; silver-colored



Item No.: 210-118
Steel carrier rail; 35 x 15 mm; 2.3 mm thick; 2 m long; unslotted; according to EN 60715; silver-colored



Item No.: 210-115
Steel carrier rail; 35 x 7.5 mm; 1 mm thick; 2 m long; slotted; according to EN 60715; "Hole width 18 mm; silver-colored



Item No.: 210-112
Steel carrier rail; 35 x 7.5 mm; 1 mm thick; 2 m long; slotted; according to EN 60715; "Hole width 25 mm; silver-colored



Item No.: 210-504
Steel carrier rail; 35 x 7.5 mm; 1 mm thick; 2 m long; slotted; galvanized; according to EN 60715; silver-colored



Item No.: 210-113
Steel carrier rail; 35 x 7.5 mm; 1 mm thick; 2 m long; unslotted; according to EN 60715; silver-colored



Item No.: 210-505
Steel carrier rail; 35 x 7.5 mm; 1 mm thick; 2 m long; unslotted; galvanized; according to EN 60715; silver-colored

1.2.2 End plate

1.2.2.1 End plate



Item No.: 284-334
Step-down cover plate; 1 mm thick; for 2-, 3- and 4-conductor terminal blocks; gray



Item No.: 284-344
Step-down cover plate; 1 mm thick; for 2-, 3- and 4-conductor terminal blocks; orange

1.2.3 Ferrule

1.2.3.1 Ferrule



Item No.: 216-301
Ferrule; Sleeve for 0.25 mm² / AWG 24; insulated; electro-tin plated; yellow



Item No.: 216-302
Ferrule; Sleeve for 0.34 mm² / 22 AWG; insulated; electro-tin plated; light turquoise



Item No.: 216-201
Ferrule; Sleeve for 0.5 mm² / 20 AWG; insulated; electro-tin plated; electrolytic copper; acc. to DIN 46228, Part 4/09.90; white



Item No.: 216-101
Ferrule; Sleeve for 0.5 mm² / AWG 22; un-insulated; electro-tin plated; silver-colored

1.2.3.1 Ferrule



Item No.: 216-202

Ferrule; Sleeve for 0.75 mm² / 18 AWG; insulated; electro-tin plated; gray



Item No.: 216-102

Ferrule; Sleeve for 0.75 mm² / AWG 20; uninsulated; electro-tin plated; silver-colored



Item No.: 216-203

Ferrule; Sleeve for 1 mm² / AWG 18; insulated; electro-tin plated; red



Item No.: 216-103

Ferrule; Sleeve for 1 mm² / AWG 18; uninsulated; electro-tin plated



Item No.: 216-204

Ferrule; Sleeve for 1.5 mm² / AWG 16; insulated; electro-tin plated; black



Item No.: 216-104

Ferrule; Sleeve for 1.5 mm² / AWG 16; uninsulated; electro-tin plated; silver-colored

1.2.4 Installation

1.2.4.1 Cover



Item No.: 709-153

Cover; Type 1; suitable for cover carrier, type 1; 1 m long; transparent

1.2.4.2 Cover carrier



Item No.: 709-167

Cover carrier; Type 1; incl. fixing/retaining screws and knurled nut; suitable for 279 to 282 and 880 Series rail-mounted terminal blocks; suitable for 264 Series miniature rail-mounted terminal blocks; suitable for 270 Series sensor and actuator terminal blocks; gray

1.2.4.3 Mounting accessories



Item No.: 209-106

Mounting carrier; for isolated mounting on DIN 35 rails; gray



Item No.: 249-116

Screwless end stop; 6 mm wide; for DIN-rail 35 x 15 and 35 x 7.5; gray

1.2.5 Insulation stop

1.2.5.1 Insulation stop



Item No.: 280-470

Insulation stop; 0.08 - 0.2 mm² "s" (0.14 mm² "f-st"); 5 pieces/strip; white



Item No.: 280-471

Insulation stop; 0.25 - 0.5 mm²; 5 pieces/strip; light gray



Item No.: 280-472

Insulation stop; 0.75 - 1 mm²; 5 pieces/strip; black

1.2.6 Jumper

1.2.6.1 Jumper



Item No.: 280-490
Jumper; 10-way; insulated; gray



Item No.: 280-482
Jumper; 2-way; insulated; gray



Item No.: 280-492
Jumper; 2-way; insulated; gray



Item No.: 280-483
Jumper; 3-way; insulated; gray



Item No.: 280-484
Jumper; 4-way; insulated; gray



Item No.: 280-485
Jumper; 5-way; insulated; gray



Item No.: 280-402
Jumper; insulated; gray



Item No.: 280-409
Jumper; insulated; gray



Item No.: 280-422
Jumper; insulated; yellow-green



Item No.: 780-452
Staggered jumper; from 1 to 2; insulated; gray



Item No.: 780-453
Staggered jumper; from 1 to 3; insulated; gray



Item No.: 780-454
Staggered jumper; from 1 to 4; insulated; gray



Item No.: 780-455
Staggered jumper; from 1 to 5; insulated; gray



Item No.: 780-456
Staggered jumper; from 1 to 6; insulated; gray



Item No.: 780-457
Staggered jumper; from 1 to 7; insulated; gray



Item No.: 780-458
Staggered jumper; from 1 to 8; insulated; gray



Item No.: 284-414
Step-down jumper; from 284/282 to 281/280/279 series; insulated; gray



Item No.: 709-110
Wire commoning chain; 2.5 mm²; insulated; black



Item No.: 709-111
Wire commoning chain; 2.5 mm²; insulated; black



Item No.: 709-112
Wire commoning chain; 2.5 mm²; insulated; black



Item No.: 210-103
Wire commoning chain; insulated; black



Item No.: 210-123
Wire commoning chain; insulated; blue

1.2.7 Marking

1.2.7.1 Double marker carrier



Item No.: 209-128
Adaptor; gray

1.2.7.2 Group marker carrier



Item No.: 209-140
Group marker carrier; gray



Item No.: 209-141
Group marker carrier; gray



Item No.: 209-142
Group marker carrier; gray



Item No.: 249-105
Group marker carrier; gray

1.2.7.3 Marker



Item No.: 793-5501
WMB marking card; as card; for terminal block width 5 - 17.5 mm; stretchable 5 - 5.2 mm; plain; snap-on type; white



Item No.: 793-501
WMB marking card; as card; not stretchable; plain; snap-on type; white



Item No.: 2009-115
WMB-Inline; for Smart Printer; 1500 pieces on roll; stretchable 5 - 5.2 mm; plain; snap-on type; white

1.2.8 Plug

1.2.8.1 Component module with diode



Item No.: 280-803/281-411

Component plug; 2-pole; with diode 1N4007; 10 mm wide; gray



Item No.: 280-803/281-420

Component plug; 2-pole; with rectifier diode and LED; 10 mm wide; gray



Item No.: 280-803/281-421

Component plug; 2-pole; with rectifier diode and LED; 10 mm wide; gray

1.2.8.2 Component module with LED



Item No.: 280-803/281-415

Component plug; 2-pole; LED (red); 10 mm wide; gray



Item No.: 280-803/281-416

Component plug; 2-pole; LED (red); 10 mm wide; gray



Item No.: 280-803/281-413

Component plug; 2-pole; LED (red); 24 VDC; 10 mm wide; gray



Item No.: 280-803/281-414

Component plug; 2-pole; LED (red); 48 VDC; 10 mm wide; gray



Item No.: 280-803/281-420

Component plug; 2-pole; with rectifier diode and LED; 10 mm wide; gray



Item No.: 280-803/281-421

Component plug; 2-pole; with rectifier diode and LED; 10 mm wide; gray

1.2.8.3 Empty component plug housing



Item No.: 280-803

Empty component plug housing; 10 mm wide; Type 4; 2-pole; gray

1.2.8.4 Neon indicator module



Item No.: 280-803/281-417

Component plug; 2-pole; 10 mm wide; gray



Item No.: 280-803/281-418

Component plug; 2-pole; 10 mm wide; gray

1.2.9 Protective warning marker

1.2.9.1 Cover



Item No.: 280-415

Protective warning marker; for 5 terminal blocks; with high-voltage symbol, black; yellow

1.2.10 Push-in type wire jumper

1.2.10.1 Jumper



Item No.: 249-126

Push-in type wire jumper; 0.75 mm²; insulated; 110 mm long; black



Item No.: 249-123

Push-in type wire jumper; 0.75 mm²; insulated; 180 mm long; black



Item No.: 249-127

Push-in type wire jumper; 0.75 mm²; insulated; 250 mm long; black



Item No.: 249-125

Push-in type wire jumper; insulated; 60 mm long; black

1.2.11 Test and measurement

1.2.11.1 Testing accessories



Item No.: 249-107

B-type spacer module; modular; e.g., for bridging commoned terminal blocks; gray



Item No.: 249-106

B-type test plug module; modular; 1,50 mm²; gray



Item No.: 249-147

B-type test plug module; modular; 2,50 mm²; gray



Item No.: 249-142

L-type end module; modular; with rigid contact pin; End module; 1,50 mm²; gray



Item No.: 249-143

L-type spacer module; modular; e.g., bridging commoned terminal blocks; gray



Item No.: 249-141

L-type test plug module; modular; with spring-loaded contact pin; Center module; 1,50 mm²; gray



Item No.: 280-419

Spacer module; modular; bridging commoned terminal blocks; gray



Item No.: 280-404

Test plug adapter; 5 mm wide; for test plug (2.3 mm Ø); suitable for 1.5 mm² - 4 mm² tbs; gray



Item No.: 209-170

Test plug adapter; 8.3 mm wide; for 4 mm Ø test plugs; suitable for 1.5 mm² - 10 mm² tbs; gray



Item No.: 280-418

Test plug module; modular; suitable for all WAGO 280 and 780 Series rail-mounted terminal blocks with jumper slots in the current bar; gray



Item No.: 281-407

Test plug; 6 mm wide; Nominal current 24 A; for 0.08 mm² - 2.5 mm²; gray

1.2.12 Tool

1.2.12.1 Operating tool



Item No.: 210-658

Operating tool; Blade: 3.5 x 0.5 mm; with a partially insulated shaft; angled; short; multicoloured



Item No.: 210-720

Operating tool; Blade: 3.5 x 0.5 mm; with a partially insulated shaft; multicoloured



Item No.: 210-657

Operating tool; Blade: 3.5 x 0.5 mm; with a partially insulated shaft; short; multicoloured

Installation Notes

Installation

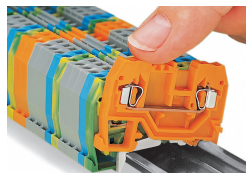

Snapping a terminal block onto the DIN-rail.

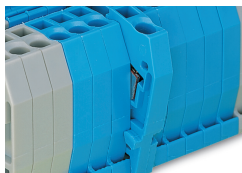

Quick assembly keys prevent reverse mounting.

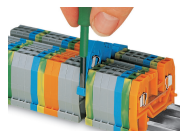

Removing a terminal block from the assembly.

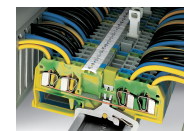

Steel DIN-rails are not suited for PEN (ground and N-conductor) applications per EN 60947-7-2 (VDE 0611, Part 3).

Conductor termination

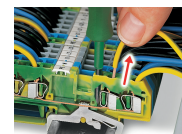

CAGE CLAMP® connection
Inserting a conductor.

CAGE CLAMP® connection
Inserting a conductor.
With ferruled conductors, it is necessary to use a terminal block one size larger than the conductor's nominal cross-section.

Inserting insulation stops.

CAGE CLAMP® connection
Removing a solid conductor.

Commoning



Commoning using an adjacent jumper.
Push jumper down until fully inserted!

Testing

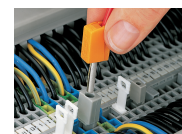
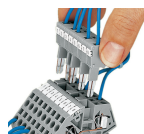
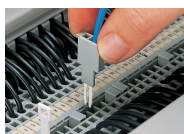

Testing with a test plug.
Picture shows a test plug fitted with CAGE CLAMP®.

L-type test plug modules fitted with CAGE CLAMP®

B-type test plug modules fitted with CAGE CLAMP®

Testing with a test plug.
Picture shows a test plug adapter (209-170).

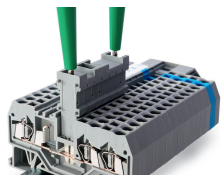

Test plugs modules are directly plugged into the jumper contact slot of the current bar.

Cover

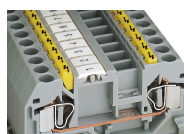

Protective warning markers inserted into the operating slots

Marking

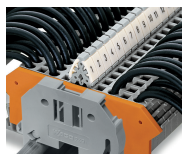
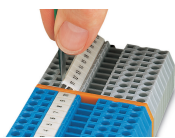

Labeling via WMB Multi Marking System.

Terminal block marking with double marker carriers (209-128) Terminal blocks with side marking