

## Data Sheet | Item Number: 2022-1404/999-953

2-conductor/2-pin carrier terminal block; 2.5 mm<sup>2</sup>; suitable for Ex nA applications; for DIN-rail 35 x 15 and 35 x 7.5; Push-in CAGE CLAMP®; 2,50 mm<sup>2</sup>; blue

<https://www.wago.com/2022-1404/999-953>

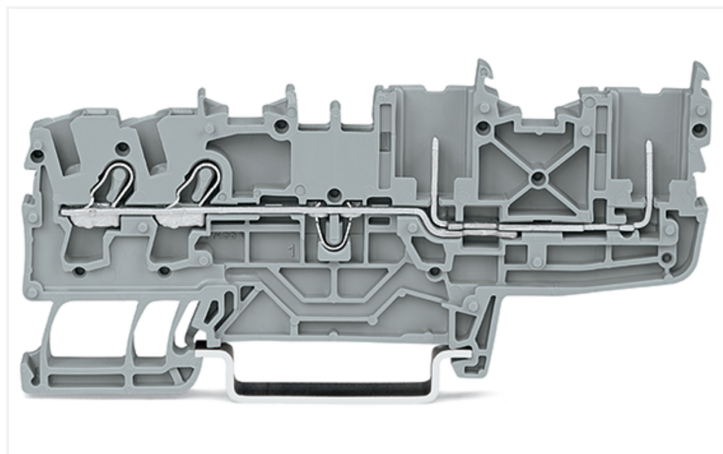

Color: ■ blue

Similar to illustration

### 2-conductor/2-pin carrier terminal block, 2022 Series, Push-in CAGE CLAMP®

Enjoy convenient electrical installations with 2-conductor/2-pin carrier terminal block (item number 2022-1404/999-953). Ensure that the strip lengths are between 10 and 12 mm when connecting conductors to 2-conductor/2-pin carrier terminal block. Pluggable rail-mount terminal blocks are hugely popular in switchgear and control systems, for example, in railroad technology. They combine the best of rail-mount terminal blocks and connectors for the perfect solution. Variable wiring systems make pre-assembly easy, which saves both time and money in production, installation, operation, and maintenance. Featuring conductor terminals along with Push-in CAGE CLAMP®, this connector outperforms the competition. Push-in CAGE CLAMP® technology provides a universal connection solution for all conductor types. It allows both solid and fine-stranded conductors with ferrules to be inserted directly into the clamping point without the need for tools. Depending on the conductor type, 2-conductor/2-pin carrier terminal block is ideal for conductor cross sections ranging from 0.25 mm<sup>2</sup> to 4 mm<sup>2</sup>.

This pluggable rail-mount terminal block is operated with an operating tool. This product is designed for specific Ex applications (please refer to the product datasheet).

#### Notes

Safety Information

A separator plate (Item No. 209-191) or a 10 mm end stop (Item No. 249-117) must be placed at the end of a WAGO X-COM®S-SYSTEM terminal strip.

#### Electrical data

Ratings per	IEC/EN 60947-7-1		
Overvoltage category	III	III	II
Pollution degree	3	2	2
Nominal voltage	-	-	-
Rated impulse withstand voltage	-	-	-
Rated current	-	-	-

Approvals per	UL 1059		
Use group	B	C	D
Rated voltage	600 V	600 V	-
Rated current	20 A	20 A	-

Approvals per	CSA 22.2 No 158		
Use group	B	C	D
Rated voltage	-	600 V	-
Rated current	-	20 A	-

Ex information	
Rated voltage EN (Ex e II)	630 V

Power Loss	
Power loss, per pole (potential)	0.532 W
Rated current $I_N$ for power loss specification	20 A
Resistance value for specified, current-dependent power loss	0.00133 $\Omega$

General information	
Wiring direction	Front-entry wiring

## Connection Data

Clamping units	2
Female plug slots	2
Total number of potentials	1
Number of levels	1

Connection 1	
Connection technology	Push-in CAGE CLAMP®
Actuation type	Operating tool
Connectable conductor materials	Copper
Nominal cross-section	2.5 mm <sup>2</sup>
Solid conductor	0.25 ... 4 mm <sup>2</sup> / 22 ... 12 AWG
Solid conductor; push-in termination	0.75 ... 4 mm <sup>2</sup> / 18 ... 12 AWG
Fine-stranded conductor	0.25 ... 4 mm <sup>2</sup> / 22 ... 12 AWG
Fine-stranded conductor; with insulated ferrule	0.25 ... 2.5 mm <sup>2</sup> / 22 ... 14 AWG
Fine-stranded conductor; with ferrule; push-in termination	1 ... 2.5 mm <sup>2</sup> / 18 ... 14 AWG
Note (conductor cross-section)	Depending on the conductor characteristic, a conductor with a smaller cross-section can also be inserted via push-in termination.
Strip length	10 ... 12 mm / 0.39 ... 0.47 inches
Wiring direction	Front-entry wiring

## Physical data

Width	5.2 mm / 0.205 inches
Height	86.2 mm / 3.394 inches
Depth from upper-edge of DIN-rail	36.4 mm / 1.433 inches

## Mechanical data

Design	horizontal type
Mounting type	DIN-35 rail
Marking level	Center/side marking

## Material data

Note (material data)	<a href="#">Information on material specifications can be found here</a>
Color	blue
Material group	I
Insulation material (main housing)	Polyamide (PA66)
Flammability class per UL94	V0
Fire load	0.187 MJ
Weight	9.2 g

### Environmental requirements

Processing temperature	-35 ... +85 °C
Continuous operating temperature	-60 ... +105 °C

### Commercial data

PU (SPU)	50 pcs
Packaging type	Box
Country of origin	CN
GTIN	4050821644811
Customs tariff number	85366990990

### Product Classification

UNSPSC	39121410
eCl@ss 10.0	27-14-11-20
eCl@ss 9.0	27-14-11-20
ETIM 9.0	EC000897
ETIM 10.0	EC000897
ECCN	NO US CLASSIFICATION

### Environmental Product Compliance

RoHS Compliance Status	Compliant, No Exemption
------------------------	-------------------------

### Approvals / Certificates

#### General approvals



Approval	Standard	Certificate Name
CCA DEKRA Certification B.V.	EN 60947	NTR CCA NL-7864
CSA CSA Group	C22.2 No. 158	2437422
DEKRA DEKRA Certification B.V.	EN 60947	71-145809
KEMA/KEUR DEKRA Certification B.V.	EN 60947	71-116567
UL Underwriters Laboratories Inc.	UL 1059	E45172

#### Declarations of conformity and manufacturer's declarations

Approval	Standard	Certificate Name
EU-Declaration of Confor- mity WAGO GmbH & Co. KG	-	-
UK-Declaration of Confor- mity WAGO GmbH & Co. KG	-	-

### Approvals for hazardous areas



Approval	Standard	Certificate Name
ATEX Physikalisch Technische Bundesanstalt	EN IEC 60079-0	PTB 13 ATEX 1004 U (II 3 G Ex ec II C Gc)
CCC CNEX	GB/T 3836.3	2020312313000255 (Ex ec IIC Gc)
IECEx Physikalisch Technische Bundesanstalt	IEC 60079-0	IECEx PTB 13.0004U (Ex ec IIC Gc)

**Downloads**

**Environmental Product Compliance**

<b>Compliance Search</b>			
Environmental Product Compliance			↓
2022-1404/999-953			

**Documentation**

<b>Bid Text</b>			
2022-1404/999-953	19.02.2019	xml 4.00 KB	↓
2022-1404/999-953	14.05.2019	docx 15.44 KB	↓

**CAD/CAE-Data**

<b>CAD data</b>	
2D/3D Models	↓
2022-1404/999-953	

<b>CAE data</b>	
EPLAN Data Portal	↓
2022-1404/999-953	
WSCAD Universe	↓
2022-1404/999-953	
ZUKEN Portal	↓
2022-1404/999-953	

**1 Compatible Products**

**1.1 System counterpart**

**1.1.1 Female connector/socket**



**Item No.: 2022-102/999-953**  
 1-conductor female connector; Push-in CAGE CLAMP®; 4 mm²; Pin spacing 5.2 mm; 2-pole; Centered locking levers; 4,00 mm²; gray

**1.2 Required Accessories**

**1.2.1 End plate**

**1.2.1.1 End plate**



**Item No.: 2022-1491**  
 End and intermediate plate; 1 mm thick; gray



**Item No.: 2022-1492**  
 End and intermediate plate; 1 mm thick; orange

### 1.3 Optional Accessories

#### 1.3.1 Coding

##### 1.3.1.1 Coding



**Item No.: 2022-100**

Carrier with 6 coding pins; for coding of female plugs; orange

#### 1.3.2 DIN-rail

##### 1.3.2.1 Mounting accessories



**Item No.: 210-196**

Aluminum carrier rail; 35 x 8.2 mm; 1.6 mm thick; 2 m long; unslotted; similar to EN 60715; silver-colored



**Item No.: 210-198**

Copper carrier rail; 35 x 15 mm; 2.3 mm thick; 2 m long; unslotted; according to EN 60715; copper-colored



**Item No.: 210-197**

Steel carrier rail; 35 x 15 mm; 1.5 mm thick; 2 m long; slotted; similar to EN 60715; silver-colored



**Item No.: 210-114**

Steel carrier rail; 35 x 15 mm; 1.5 mm thick; 2 m long; unslotted; similar to EN 60715; silver-colored



**Item No.: 210-118**

Steel carrier rail; 35 x 15 mm; 2.3 mm thick; 2 m long; unslotted; according to EN 60715; silver-colored



**Item No.: 210-115**

Steel carrier rail; 35 x 7.5 mm; 1 mm thick; 2 m long; slotted; according to EN 60715; "Hole width 18 mm; silver-colored



**Item No.: 210-112**

Steel carrier rail; 35 x 7.5 mm; 1 mm thick; 2 m long; slotted; according to EN 60715; "Hole width 25 mm; silver-colored



**Item No.: 210-113**

Steel carrier rail; 35 x 7.5 mm; 1 mm thick; 2 m long; unslotted; according to EN 60715; silver-colored

#### 1.3.3 Ferrule

##### 1.3.3.1 Ferrule



**Item No.: 216-241**

Ferrule; Sleeve for 0.5 mm<sup>2</sup> / 20 AWG; insulated; electro-tin plated; electrolytic copper; gastight crimped; acc. to DIN 46228, Part 4/09.90; white



**Item No.: 216-242**

Ferrule; Sleeve for 0.75 mm<sup>2</sup> / 18 AWG; insulated; electro-tin plated; electrolytic copper; gastight crimped; acc. to DIN 46228, Part 4/09.90; gray



**Item No.: 216-262**

Ferrule; Sleeve for 0.75 mm<sup>2</sup> / 18 AWG; insulated; electro-tin plated; electrolytic copper; gastight crimped; acc. to DIN 46228, Part 4/09.90; gray



**Item No.: 216-243**

Ferrule; Sleeve for 1 mm<sup>2</sup> / AWG 18; insulated; electro-tin plated; electrolytic copper; gastight crimped; acc. to DIN 46228, Part 4/09.90; red



**Item No.: 216-263**

Ferrule; Sleeve for 1 mm<sup>2</sup> / AWG 18; insulated; electro-tin plated; electrolytic copper; gastight crimped; acc. to DIN 46228, Part 4/09.90; red



**Item No.: 216-244**

Ferrule; Sleeve for 1.5 mm<sup>2</sup> / AWG 16; insulated; electro-tin plated; electrolytic copper; gastight crimped; acc. to DIN 46228, Part 4/09.90; black



**Item No.: 216-264**

Ferrule; Sleeve for 1.5 mm<sup>2</sup> / AWG 16; insulated; electro-tin plated; electrolytic copper; gastight crimped; acc. to DIN 46228, Part 4/09.90; black



**Item No.: 216-284**

Ferrule; Sleeve for 1.5 mm<sup>2</sup> / AWG 16; insulated; electro-tin plated; electrolytic copper; gastight crimped; acc. to DIN 46228, Part 4/09.90; black



**Item No.: 216-246**

Ferrule; Sleeve for 2.5 mm<sup>2</sup> / AWG 14; insulated; electro-tin plated; electrolytic copper; gastight crimped; acc. to DIN 46228, Part 4/09.90; blue



**Item No.: 216-266**

Ferrule; Sleeve for 2.5 mm<sup>2</sup> / AWG 14; insulated; electro-tin plated; electrolytic copper; gastight crimped; acc. to DIN 46228, Part 4/09.90; blue



**Item No.: 216-286**

Ferrule; Sleeve for 2.5 mm<sup>2</sup> / AWG 14; insulated; electro-tin plated; electrolytic copper; gastight crimped; acc. to DIN 46228, Part 4/09.90; blue

1.3.4 Insulation stop

1.3.4.1 Insulation stop



**Item No.: 2002-171**

Insulation stop; 0.25 - 0.5 mm<sup>2</sup>; 5 pieces/strip; light gray

**Item No.: 2002-172**

Insulation stop; 0.75 - 1 mm<sup>2</sup>; 5 pieces/strip; dark gray

1.3.5 Jumper

1.3.5.1 Jumper



**Item No.: 2002-400**

Continuous jumper; 2-way; insulated; light gray



**Item No.: 2002-413**

Continuous jumper; 3-way; insulated; light gray



**Item No.: 2002-415**

Continuous jumper; 5-way; insulated; light gray



**Item No.: 2002-423/000-006**

Continuous jumper; from 1 to 3; insulated; blue



**Item No.: 2002-423**

Continuous jumper; from 1 to 3; insulated; light gray



**Item No.: 2002-423/000-005**

Continuous jumper; from 1 to 3; insulated; red



**Item No.: 2002-424/000-006**

Continuous jumper; from 1 to 4; insulated; blue



**Item No.: 2002-424**

Continuous jumper; from 1 to 4; insulated; light gray



**Item No.: 2002-424/000-005**

Continuous jumper; from 1 to 4; insulated; red



**Item No.: 2002-406/020-000**

Delta jumper; insulated; light gray



**Item No.: 2002-410/000-006**

Jumper; 10-way; insulated; blue



**Item No.: 2002-410**

Jumper; 10-way; insulated; light gray



**Item No.: 2002-410/000-005**

Jumper; 10-way; insulated; red



**Item No.: 2002-402/000-006**

Jumper; 2-way; insulated; blue



**Item No.: 2002-402**

Jumper; 2-way; insulated; light gray



**Item No.: 2002-402/000-005**

Jumper; 2-way; insulated; red



**Item No.: 2002-403/000-006**

Jumper; 3-way; insulated; blue



**Item No.: 2002-403**

Jumper; 3-way; insulated; light gray



**Item No.: 2002-403/000-005**

Jumper; 3-way; insulated; red



**Item No.: 2002-404/000-006**

Jumper; 4-way; insulated; blue



**Item No.: 2002-404**

Jumper; 4-way; insulated; light gray



**Item No.: 2002-404/000-005**

Jumper; 4-way; insulated; red



**Item No.: 2002-405/000-006**

Jumper; 5-way; insulated; blue



**Item No.: 2002-405**

Jumper; 5-way; insulated; light gray



**Item No.: 2002-405/000-005**

Jumper; 5-way; insulated; red



**Item No.: 2002-406/000-006**

Jumper; 6-way; insulated; blue



**Item No.: 2002-406**

Jumper; 6-way; insulated; light gray



**Item No.: 2002-406/000-005**

Jumper; 6-way; insulated; red



**Item No.: 2002-407/000-006**

Jumper; 7-way; insulated; blue



**Item No.: 2002-407**

Jumper; 7-way; insulated; light gray



**Item No.: 2002-407/000-005**

Jumper; 7-way; insulated; red



**Item No.: 2002-408/000-006**

Jumper; 8-way; insulated; blue



**Item No.: 2002-408**

Jumper; 8-way; insulated; light gray



**Item No.: 2002-408/000-005**

Jumper; 8-way; insulated; red



**Item No.: 2002-409/000-006**

Jumper; 9-way; insulated; blue



**Item No.: 2002-409**

Jumper; 9-way; insulated; light gray



**Item No.: 2002-409/000-005**

Jumper; 9-way; insulated; red



**Item No.: 2002-440**

Jumper; from 1 to 10; insulated; light gray



**Item No.: 2002-433**

Jumper; from 1 to 3; insulated; light gray



**Item No.: 2002-434**

Jumper; from 1 to 4; insulated; light gray



**Item No.: 2002-435**

Jumper; from 1 to 5; insulated; light gray



**Item No.: 2002-436**

Jumper; from 1 to 6; insulated; light gray



**Item No.: 2002-437**

Jumper; from 1 to 7; insulated; light gray



**Item No.: 2002-438**



Jumper; from 1 to 8; insulated; light gray

1.3.5.1 Jumper





 <b>Item No.: 2002-439</b> Jumper; from 1 to 9; insulated; light gray	 <b>Item No.: 2002-480</b> Staggered jumper; 10-way; insulated; light gray	 <b>Item No.: 2002-481</b> Staggered jumper; 11-way; insulated; light gray	 <b>Item No.: 2002-482</b> Staggered jumper; 12-way; insulated; light gray
 <b>Item No.: 2002-473/011-000</b> Staggered jumper; 2-way; from 1 to 3; insulated; light gray	 <b>Item No.: 2002-472</b> Staggered jumper; 2-way; insulated; light gray	 <b>Item No.: 2002-473</b> Staggered jumper; 3-way; insulated; light gray	 <b>Item No.: 2002-475/011-000</b> Staggered jumper; 3-way; insulated; light gray
 <b>Item No.: 2002-474</b> Staggered jumper; 4-way; insulated; light gray	 <b>Item No.: 2002-475</b> Staggered jumper; 5-way; insulated; light gray	 <b>Item No.: 2002-476</b> Staggered jumper; 6-way; insulated; light gray	 <b>Item No.: 2002-477</b> Staggered jumper; 7-way; insulated; light gray
 <b>Item No.: 2002-478</b> Staggered jumper; 8-way; insulated; light gray	 <b>Item No.: 2002-479</b> Staggered jumper; 9-way; insulated; light gray	 <b>Item No.: 2002-477/011-000</b> Staggered jumper; insulated; light gray	 <b>Item No.: 2002-479/011-000</b> Staggered jumper; insulated; light gray
 <b>Item No.: 2002-481/011-000</b> Staggered jumper; insulated; light gray	 <b>Item No.: 2002-405/011-000</b> Star point jumper; 3-way; insulated; light gray	 <b>Item No.: 210-103</b> Wire commoning chain; insulated; black	 <b>Item No.: 210-123</b> Wire commoning chain; insulated; blue

1.3.6 Marking



1.3.6.1 Group marker carrier

 <b>Item No.: 2009-191</b> Group marker carrier; gray	 <b>Item No.: 2009-192</b> Group marker carrier; gray	 <b>Item No.: 2009-193</b> Group marker carrier; gray
--	--	--

1.3.6.2 Marker

 <b>Item No.: 2009-145</b> Mini-WSB Inline; for Smart Printer; 1700 pieces on roll; stretchable 5 - 5.2 mm; plain; snap-on type; white	 <b>Item No.: 248-501</b> Mini-WSB marking card; as card; not stretchable; plain; snap-on type; white	 <b>Item No.: 793-5501</b> WMB marking card; as card; for terminal block width 5 - 17.5 mm; stretchable 5 - 5.2 mm; plain; snap-on type; white	 <b>Item No.: 2009-115</b> WMB-Inline; for Smart Printer; 1500 pieces on roll; stretchable 5 - 5.2 mm; plain; snap-on type; white
---	--	--	--

1.3.6.3 Marker carrier

 <b>Item No.: 2002-161</b> Adaptor; gray	 <b>Item No.: 2009-198</b> Adaptor; gray
---	---

1.3.6.4 Marking strip

 <b>Item No.: 2009-110</b> Marking strips; for Smart Printer; on reel; not stretchable; plain; snap-on type; white
---

### 1.3.7 Protective warning marker

#### 1.3.7.1 Cover



**Item No.: 2002-115**

Protective warning marker; for 5 terminal blocks; with high-voltage symbol, black; yellow

### 1.3.8 Push-in type wire jumper

#### 1.3.8.1 Jumper



**Item No.: 2009-414**

Push-in type wire jumper; 1.5 mm<sup>2</sup>; insulated; 110 mm long; black



**Item No.: 2009-414/000-005**

Push-in type wire jumper; 1.5 mm<sup>2</sup>; insulated; 110 mm long; black



**Item No.: 2009-416**

Push-in type wire jumper; 1.5 mm<sup>2</sup>; insulated; 250 mm long; black



**Item No.: 2009-414/000-006**

Push-in type wire jumper; insulated; 110 mm long; black



**Item No.: 2009-412**

Push-in type wire jumper; insulated; 60 mm long; black

### 1.3.9 Screwless end stop

#### 1.3.9.1 Mounting accessories



**Item No.: 249-117**

Screwless end stop; 10 mm wide; for DIN-rail 35 x 15 and 35 x 7.5; gray



**Item No.: 249-116**

Screwless end stop; 6 mm wide; for DIN-rail 35 x 15 and 35 x 7.5; gray

### 1.3.10 Test and measurement

#### 1.3.10.1 Testing accessories



**Item No.: 2002-560**

Modular TOPJOB®S connector; modular; for jumper contact slot; 10-pole; gray



**Item No.: 2002-511**

Modular TOPJOB®S connector; modular; for jumper contact slot; 1-pole; gray



**Item No.: 2002-552**

Modular TOPJOB®S connector; modular; for jumper contact slot; 2-pole; gray



**Item No.: 2002-553**

Modular TOPJOB®S connector; modular; for jumper contact slot; 3-pole; gray



**Item No.: 2002-554**

Modular TOPJOB®S connector; modular; for jumper contact slot; 4-pole; gray



**Item No.: 2002-555**

Modular TOPJOB®S connector; modular; for jumper contact slot; 5-pole; gray



**Item No.: 2002-556**

Modular TOPJOB®S connector; modular; for jumper contact slot; 6-pole; gray



**Item No.: 2002-557**

Modular TOPJOB®S connector; modular; for jumper contact slot; 7-pole; gray



**Item No.: 2002-558**

Modular TOPJOB®S connector; modular; for jumper contact slot; 8-pole; gray



**Item No.: 2002-559**

Modular TOPJOB®S connector; modular; for jumper contact slot; 9-pole; gray



**Item No.: 2002-549**

Spacer module; modular; e.g., for bridging commoned terminal blocks; gray



**Item No.: 2009-174**

Test plug adapter; for 4 mm Ø test plugs; for testing TOPJOB®S rail-mounted terminal blocks; gray



**Item No.: 2009-182**

Testing tap; for max. 2.5 mm<sup>2</sup>; tool-free connection for individual test wires 0.08 - 2.5 mm; gray



**Item No.: 859-500**

WAGO Test pin; 1 mm Ø; 30 V AC / 60 V DC; CAT0; 1 A; 10 mm uninsulated; Test lead for soldering up to 0,5mm<sup>2</sup>

### 1.3.11 Tool

#### 1.3.11.1 Operating tool



**Item No.: 210-720**

Operating tool; Blade: 3.5 x 0.5 mm; with a partially insulated shaft; multicoloured

### Installation Notes

#### Installation



Snap individual carrier terminal blocks onto the DIN-rail and slide together.

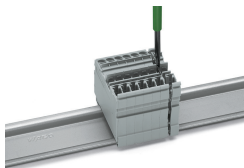

Open the assembly by laterally sliding a block via operating tool (3.5 x 0.5 mm blade).

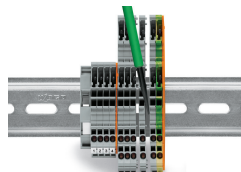

Separate terminal block assembly and slide individual terminal blocks laterally using an operating tool.

### Conductor termination

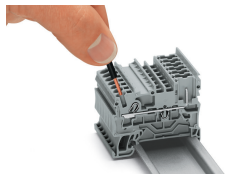

Push-in CAGE CLAMP® enables solid conductors to be connected by simply pushing them into the unit.

### Commoning

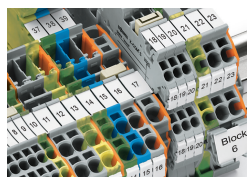

Commoning X-COM®S-SYSTEM Terminal Blocks using jumpers for TOPJOB® S Terminal Blocks. An end plate provides connection to TOPJOB® S Terminal Blocks. 2020 and 2022 Series Terminal Blocks are combinable. Jumper slots are on the same level for both series.

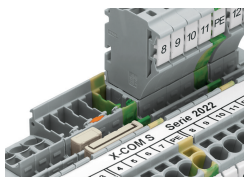

Pairing push-in comb style jumpers.

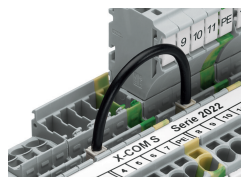

Commoning with push-in type wire jumper.

### Testing

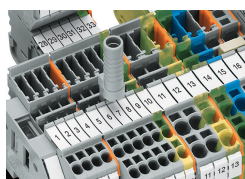

Test plug adapter (Item No. 2009-174) for 4 mm test plugs or banana plugs – also suitable for X-COM®S-SYSTEM-MINI Terminal Blocks.

### Coding

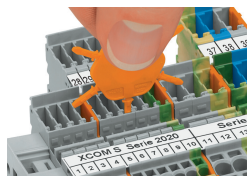

Insert coding pin into the corresponding slot and twist it off.



Coding a female plug: remove coding finger using a suitable tool.

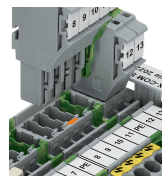

Insert a coding pin (Item No. 2022-100) into the corresponding location of the carrier terminal block.

### Ex application



630 V = rated voltage for use in Zone 2 hazardous areas, "ec" type of protection

Ex marking:

"Ex" sign and extended item number ".../999-953" are printed on the side of both carrier terminal blocks and female plugs with Ex approval.

Shorter locking lever (factory-mounted) makes accidental disconnection more difficult.

### Marking

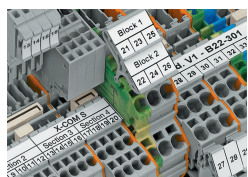

Clear marking via large marking area

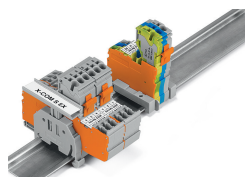

Group marking with height-adjustable group marker carrier (Item No. 2009-163)

### Security

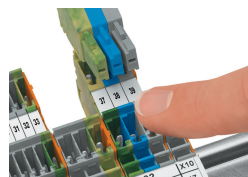

Carrier terminal blocks and female plugs are touch-proof.