

Data Sheet | Item Number: 771-8292/015-105

pre-assembled interconnecting cable; B2ca; Socket/plug; 2-pole; Cod. B; Control cable 2 x 1.0 mm²; 1 m; 1,00 mm²

<https://www.wago.com/771-8292/015-105>

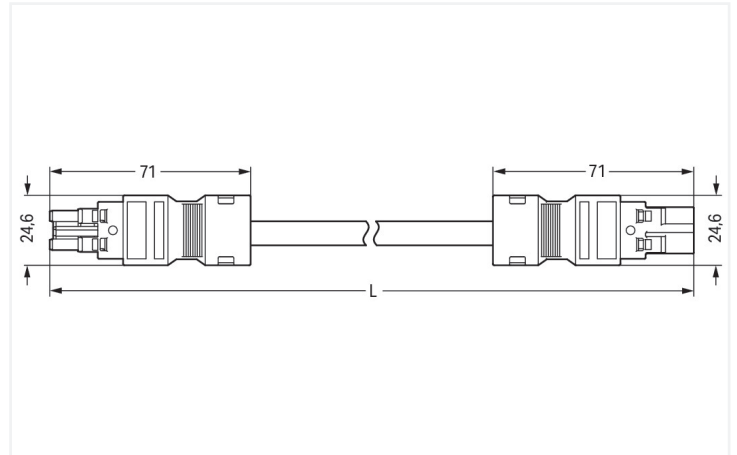

Dimensions in mm

Cable assembly WINSTA® MIDI rated current 10 A

The WINSTA® MIDI cable assembly with protection against mismatching is the pluggable solution for your application in control cabinets, for lighting connections or on PCBs. WAGO pluggable installation connectors can be used when specifications repeat or are planned on a defined pattern, for example for installing grid lighting or flush-mount lighting. The coding options reduce installation errors, allowing fast, secure wiring of all components. The pluggable installation connector is protected against ingress by solid objects in accordance with protection type IP20 (When mated: IP2xC (These compact connectors are not designed for use in open, easily accessible areas!)). Pluggable installation connectors with B coding from the WINSTA® MIDI line are available in gray, light green, or pink, allowing you to distinguish different circuits, for example for light, pumps or, sun blinds. Your own pole marking is possible as well. The WINSTA® MIDI Pluggable Connection System with Push-in CAGE CLAMP® spring pressure connection technology facilitates precise electrification. Due to the integrated test slot, it is possible to check connections even when they are plugged in. This saves time, labor, and money. Scrupulous compliance with fire protection regulations is an essential issue for building installation. Especially in sensitive areas, the fire class must meet or even exceed the high standards of requirements. This product complies with the requirements of fire class B2. Eliminating halogens as an additive in the manufacture of this cable assembly substantially improves fire safety and reduces environmental contamination.

Fast, error-free assembly thanks to cable assemblies from WAGO

The cable is pre-assembled with a socket and a plug. The WINSTA® Pluggable Connection System allows pluggable electrical installation. This significantly reduces the need for servicing and lowers costs. Choose durability and quality – with fire class B2 from WAGO makes the electrical installation of electrical components noticeably easier.

- pluggable installation connectors with protection against mismatching
- pre-assembled versions
- with B coding for use in process automation, such as lighting technology
- exact dimensions
- fast, secure installation

Notes

Note	Cables with a different fire class can be found in the eShop.
Variants:	Other pole markings Other versions (or variants) can be requested from WAGO Sales or configured at https://configurator.wago.com/ .

Electrical data

Ratings per	IEC/EN 60664-1			General information	
Overvoltage category	III	III	II	Note on contact resistance	approx. 1 mΩ of contact resistance approx. 0.25 mΩ contact transition plug/ socket
Pollution degree	3	2	2		
Nominal voltage	250 V	-	-		
Rated impulse withstand voltage	4 kV	-	-		
Rated current	10 A	-	-		

Connection Data

Total number of potentials	2	Connection 1	
		Pole number	2
		Wire cross-section	1 mm ²
		Connection type	Socket - Plug

Physical data

Pin spacing	10 mm / 0.394 inches
Width	24.6 mm / 0.969 inches
Total length	1 m

Mechanical data

Use	Control technology
Coding	B
Variable coding	No
Marking	1 2
Potential marking	1 2
Mating force of a plug-in connection	approx. 20 ... 70 N (depending on pole number)
Retention force of a plug-in connection	when locked: > 80N
Unmating force of a plug-in connection	when unlocked: approx. 20 ... 70 N (depending on pole number)
Number of mating cycles	200, without resistive load
Connection type	Socket - Plug
Type of pre-assembled cable	Interconnecting cable
Cable type	H05Z1Z1-F 2x1
Protection type	IP20; When mated: IP2xC (These compact connectors are not designed for use in open, easily accessible areas!)

Plug-in connection

Mismating protection	Yes
Note on mismating protection	All WINSTA® components are 100% protected against mismating when: a.) plugging different numbers of poles b.) plugging while rotated 180 c.) plugging while laterally staggered d.) plugging one pole
Locking lever	Can be retrofitted
Locking of plug-in connection	Locking lever
Note on locking system	All connectors for mounted installations (snap-in versions for lighting fixtures or devices, all types of PCB and distribution connectors) are factory-equipped with locking levers to ensure plugs and sockets are securely locked. Additional locking levers are only required for flying leads (plug/socket).

Material data

Note (material data)	Information on material specifications can be found here
Insulation material (main housing)	Polyamide (PA66)
Flammability class per UL94	V0
Fire class per EN 50575	B2 _{ca}
Contact material	Copper or copper alloy; surface-treated
Contact Plating	Tin
Fire load	0.629 MJ
Connector color	light green
Strain relief color	black
Sheathed cable color	gray
Printing color of sheathed cable	black
Halogen-free	Yes
Silicon-free	Yes
Sheath material	Halogen-free
Rubber cable	No
Weight	82.6 g
Copper weight of the raw cable	0.0192 kg/m

Environmental requirements

Processing temperature	-5 ... +40 °C
Continuous operating temperature	-35 ... +85 °C
Note on continuous operating temperature	Cable for temperatures ≤ 70 °C (including halogen-free) Insulating parts for temperatures ≤ 105 °C

Commercial data

PU (SPU)	1 pcs
Packaging type	unpacked
Country of origin	DE
GTIN	4055143758277
Customs tariff number	85444290900

Product Classification

UNSPSC	26121629
eCl@ss 10.0	27-44-06-04
eCl@ss 9.0	27-44-06-04
ETIM 9.0	EC002587
ETIM 10.0	EC002587
ECCN	NO US CLASSIFICATION

Environmental Product Compliance

RoHS Compliance Status	Compliant, No Exemption
------------------------	-------------------------

Downloads

Environmental Product Compliance

Compliance Search

Environmental Product Compliance 

771-8292/015-105

CAD/CAE-Data

CAE data

EPLAN Data Portal 





771-8292/015-105

1 Compatible Products

1.1 Required Accessories

1.1.1 Locking system





1.1.1.1 Locking system

			
Item No.: 770-101 Locking lever; for flying leads; for manual operation; black	Item No.: 770-121 Locking lever; for flying leads; for manual operation; white	Item No.: 770-111 Locking lever; for flying leads; for tool operation; black	Item No.: 770-131 Locking lever; for flying leads; for tool operation; white

1.2 Optional Accessories

1.2.1 Cover

1.2.1.1 Cover

			
Item No.: 770-201 Lockout cap; 12-pole, separable; for sockets; Plastic; black	Item No.: 770-221 Lockout cap; 12-pole, separable; for sockets; Plastic; white	Item No.: 770-360 Lockout cap; for plugs; 5-pole; separable; yellow	Item No.: 897-2003 Protective cap; Type2; for sockets and plugs; PVC; red

1.2.2 Installation

1.2.2.1 Mounting accessories



Item No.: 770-310

Mounting carrier; 2- to 5-pole; for flying leads; black

1.2.3 Marking

1.2.3.1 Marking strip



Item No.: 210-334

Marking strips; as a DIN A4 sheet; Strip width 5 mm; Strip length 182 mm; plain; Self-adhesive; white