

## Data Sheet | Item Number: 2001-1202

2-conductor through terminal block; 1.5 mm<sup>2</sup>; suitable for Ex e II applications; side and center marking; for DIN-rail 35 x 15 and 35 x 7.5; Push-in CAGE CLAMP®; 1,50 mm<sup>2</sup>; orange

<https://www.wago.com/2001-1202>

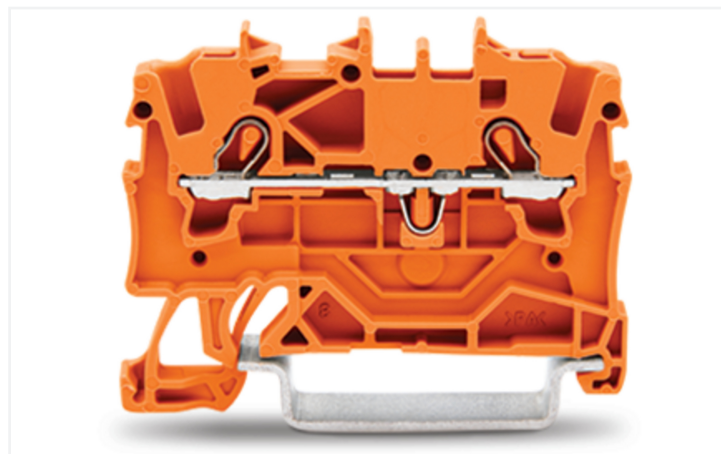
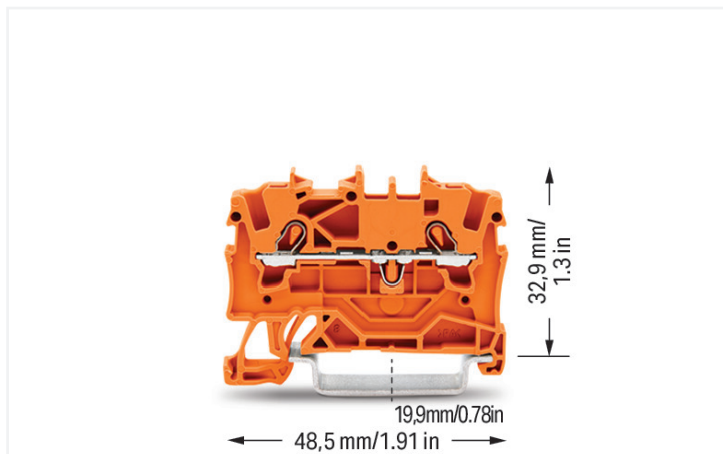

Color: ■ orange



Similar to illustration

### Through terminal block, 2001 Series, orange

Our through terminal block (item number 2001-1202) makes connecting wires quick and easy. Strip lengths must be between 9 and 11 mm when connecting conductors to this through terminal block. Whether for use in industry or building installations, our rail-mount through terminal blocks make it easy to quickly and securely connect electrical conductors. They're perfect for either classic through-wiring or distributing potential, depending on the variant. This product features conductor terminals and utilizes Push-in CAGE CLAMP®. Push-in CAGE CLAMP® technology provides a universal connection solution for any type of conductor. It allows both solid and fine-stranded conductors with ferrules to be inserted directly into the clamping point without the need for tools. The item's dimensions are (4.2 x 48.5 x 39.5) mm (width x height x depth). This through terminal block is suitable for conductor cross sections ranging from 0.25 mm<sup>2</sup> to 2.5 mm<sup>2</sup>.

An operating tool is used to operate this through rail-mount terminal block. Our TOPJOB® S rail-mount terminal blocks guarantee reliable electrical connections across many different industrial applications and modern building installations. They simplify wiring, as you can quickly plug in solid, stranded, and fine-stranded conductors with ferrules. This product is designed for specific Ex applications (please refer to the product datasheet).

## Electrical data

Ratings per	IEC/EN 60947-7-1		
Overvoltage category	III	III	II
Pollution degree	3	2	2
Nominal voltage	800 V	-	-
Rated impulse withstand voltage	8 kV	-	-
Rated current	17.5 A	-	-
Current at conductor cross-section (max.) mm <sup>2</sup>	24 A	-	-

Approvals per	UL 1059		
Use group	B	C	D
Rated voltage	600 V	600 V	-
Rated current	15 A	15 A	-

Approvals per	CSA 22.2 No 158		
Use group	B	C	D
Rated voltage	600 V	600 V	-
Rated current	15 A	15 A	-

Ex information	
Reference to hazardous areas	See application instructions in section "Knowledge and Downloads – Documentation – Additional Information: Technical Section; Technical Explanations"
Ratings per	ATEX: PTB 05 ATEX 1094 U / IECEx: PTB 05.0034U (Ex eb IIC Gb)
Rated voltage EN (Ex e II)	550 V
Rated current (Ex e II)	17 A
Rated current (Ex e II) with jumper	16 A

## Power Loss

Power loss, per pole (potential)	0.5929 W
Rated current $I_N$ for power loss specification	18 A
Resistance value for specified, current-dependent power loss	0.00183 $\Omega$

## General information

Wiring direction	Front-entry wiring
------------------	--------------------

## Connection Data

Clamping units	2
Total number of potentials	1
Number of levels	1
Number of jumper slots	2

Connection 1	
Connection technology	Push-in CAGE CLAMP®
Actuation type	Operating tool
Connectable conductor materials	Copper
Nominal cross-section	1.5 mm <sup>2</sup>
Solid conductor	0.25 ... 2.5 mm <sup>2</sup> / 22 ... 14 AWG
Solid conductor; push-in termination	0.75 ... 2.5 mm <sup>2</sup> / 18 ... 14 AWG
Fine-stranded conductor	0.25 ... 2.5 mm <sup>2</sup> / 22 ... 14 AWG
Fine-stranded conductor; with insulated ferrule	0.25 ... 1.5 mm <sup>2</sup> / 22 ... 16 AWG
Fine-stranded conductor; with ferrule; push-in termination	0.75 ... 1.5 mm <sup>2</sup> / 18 ... 16 AWG
Note (conductor cross-section)	Depending on the conductor characteristic, a conductor with a smaller cross-section can also be inserted via push-in termination.
Strip length	9 ... 11 mm / 0.35 ... 0.43 inches
Wiring direction	Front-entry wiring

### Physical data

Width	4.2 mm / 0.165 inches
Height	48.5 mm / 1.909 inches
Depth from upper-edge of DIN-rail	32.9 mm / 1.295 inches
Depth	39.5 mm / 1.555 inches

### Mechanical data

Mounting type	DIN-35 rail
Marking level	Center/side marking

### Material data

Note (material data)	<a href="#">Information on material specifications can be found here</a>
Color	orange
Material group	I
Insulation material (main housing)	Polyamide (PA66)
Flammability class per UL94	V0
Fire load	0.087 MJ
Weight	3.5 g

### Environmental requirements

Processing temperature	-35 ... +85 °C
Continuous operating temperature	-60 ... +105 °C

### Environmental Testing

Test specification: Railway applications – Rolling stock – Electronic equipment	DIN EN 50155 (VDE 0115-200):2022-06
Test procedure: Railway applications – Rolling stock equipment – Vibration and shock tests	DIN EN 61373 (VDE 0115-0106):2011-04
Spectrum/Mounting location	Service life test, Category 1, Class A/B
Functional test with noise-like oscillations	Test passed according to Section 8 of the standard
Frequency	$f_1 = 5 \text{ Hz}$ to $f_2 = 150 \text{ Hz}$
Acceleration	0.101g (highest test level used for all axes)
Test duration per axis	10 min.
Test directions	X, Y and Z axes
Monitoring of contact faults and interruptions	Passed
Voltage drop measurement before and after each axis	Passed
Simulated service life test through increased levels of noise-like oscillations	Test passed according to Section 9 of the standard
Frequency	$f_1 = 5 \text{ Hz}$ to $f_2 = 150 \text{ Hz}$
Acceleration	0.572g (highest test level used for all axes)
Test duration per axis	5 h
Test directions	X, Y and Z axes
Extended testing: Monitoring of contact faults and interruptions	Passed
Extended testing: Voltage drop measurement before and after each axis	Passed
Shock test	Test passed according to Section 10 of the standard
Shock pulse form	Half sine
Acceleration	5g (highest test level used for all axes)
Shock duration	30 ms
Number of shocks (per axis)	3 pos. und 3 neg.

Environmental Testing	
Test directions	X, Y and Z axes
Extended testing: Monitoring of contact faults and interruptions	Passed
Extended testing: Voltage drop measurement before and after each axis	Passed
Vibration and shock stress for rolling stock equipment	Passed

Commercial data	
Product Group	22 (TOPJOB S)
PU (SPU)	100 pcs
Packaging type	Box
Country of origin	DE
GTIN	4017332997300
Customs tariff number	85369010000

Product Classification	
UNSPSC	39121402
eCl@ss 10.0	27-14-11-20
eCl@ss 9.0	27-14-11-20
ETIM 9.0	EC000897
ETIM 10.0	EC000897
ECCN	NO US CLASSIFICATION

Environmental Product Compliance	
RoHS Compliance Status	Compliant, No Exemption

### Approvals / Certificates

General approvals		
Approval	Standard	Certificate Name
CCA DEKRA Certification B.V.	EN 60947	NTR NL-7963
CSA DEKRA Certification B.V.	C22.2 No. 158	1645434
KEMA/KEUR DEKRA Certification B.V.	EN 60947	71-125954
UL UL International Germany GmbH	UL 1059	E45172

Declarations of conformity and manufacturer's declarations		
Approval	Standard	Certificate Name
ATEX-Attestation of Conformity WAGO GmbH & Co. KG	-	-
EU-Declaration of Conformity WAGO GmbH & Co. KG	-	-
Railway WAGO GmbH & Co. KG	-	Railway Ready
UK-Declaration of Conformity WAGO GmbH & Co. KG	-	-

Approvals for marine applications



Approval	Standard	Certificate Name
ABS American Bureau of Ship- ping	EN 60947	24-0152298-PDA
DNV GL Det Norske Veritas, Ger- manischer Lloyd	-	TAE00001V2
PRS Polski Rejestr Statków	-	TE/1094/880590/23

Approvals for hazardous areas



Approval	Standard	Certificate Name
AEx UL International Germany GmbH c/o Physikalisch Technische Bundesanstalt	UL 60079	E185892 (AEx e II resp. Ex e II)
ATEX Physikalisch Technische Bundesanstalt (PTB)	EN 60079	PTB 05 ATEX 1094 U (II 2 G Ex eb IIC Gb bzw. I M 2 Ex eb I Mb)
CCC CQST/CNEx	GB/T 3836.3	2020312313000159 (Ex eb IIC Gb, Ex eb I Mb)
IECEX Physikalisch Technische Bundesanstalt (PTB)	IEC 60079	IECEX PTB 05.0034U (Ex eb IIC Gb or Ex eb I Mb)
INMETRO TÜV Rheinland do Brasil Ltda.	IEC 60079	TÜV 12.1308 U

Downloads

Environmental Product Compliance

Compliance Search
Environmental Product Compliance 2001-1202 <a href="#">↓</a>

Documentation

Bid Text			
2001-1202	19.02.2019	xml 3.93 KB	<a href="#">↓</a>
2001-1202	02.08.2018	docx 14.58 KB	<a href="#">↓</a>

CAD/CAE-Data

CAD data
2D/3D Models 2001-1202 <a href="#">↓</a>

CAE data
EPLAN Data Portal 2001-1202 <a href="#">↓</a>
WSCAD Universe 2001-1202 <a href="#">↓</a>
ZUKEN Portal 2001-1202 <a href="#">↓</a>

## 1 Compatible Products

### 1.1 Required Accessories

#### 1.1.1 End plate

##### 1.1.1.1 End plate



**Item No.: 2002-1291**

End and intermediate plate; 0.8 mm thick; gray



**Item No.: 2002-1292**

End and intermediate plate; 0.8 mm thick; orange



**Item No.: 209-191**

Separator for Ex e/Ex i applications; 3 mm thick; 120 mm wide; orange

### 1.2 Optional Accessories

#### 1.2.1 DIN-rail

##### 1.2.1.1 Mounting accessories



**Item No.: 210-196**

Aluminum carrier rail; 35 x 8.2 mm; 1.6 mm thick; 2 m long; unslotted; similar to EN 60715; silver-colored



**Item No.: 210-198**

Copper carrier rail; 35 x 15 mm; 2.3 mm thick; 2 m long; unslotted; according to EN 60715; copper-colored



**Item No.: 210-197**

Steel carrier rail; 35 x 15 mm; 1.5 mm thick; 2 m long; slotted; similar to EN 60715; silver-colored



**Item No.: 210-114**

Steel carrier rail; 35 x 15 mm; 1.5 mm thick; 2 m long; unslotted; similar to EN 60715; silver-colored



**Item No.: 210-118**

Steel carrier rail; 35 x 15 mm; 2.3 mm thick; 2 m long; unslotted; according to EN 60715; silver-colored



**Item No.: 210-115**

Steel carrier rail; 35 x 7.5 mm; 1 mm thick; 2 m long; slotted; according to EN 60715; "Hole width 18 mm; silver-colored



**Item No.: 210-112**

Steel carrier rail; 35 x 7.5 mm; 1 mm thick; 2 m long; slotted; according to EN 60715; "Hole width 25 mm; silver-colored



**Item No.: 210-113**

Steel carrier rail; 35 x 7.5 mm; 1 mm thick; 2 m long; unslotted; according to EN 60715; silver-colored

#### 1.2.2 End plate

##### 1.2.2.1 End plate



**Item No.: 209-190**

Separator for Ex e/Ex i applications; 3 mm thick; 90 mm wide; orange



**Item No.: 2002-1293**

Separator plate; 2 mm thick; oversized; gray



**Item No.: 2002-1294**

Separator plate; 2 mm thick; oversized; orange

#### 1.2.3 Ferrule

##### 1.2.3.1 Ferrule



**Item No.: 216-241**

Ferrule; Sleeve for 0.5 mm<sup>2</sup> / 20 AWG; insulated; electro-tin plated; electrolytic copper; gastight crimped; acc. to DIN 46228, Part 4/09.90; white



**Item No.: 216-242**

Ferrule; Sleeve for 0.75 mm<sup>2</sup> / 18 AWG; insulated; electro-tin plated; electrolytic copper; gastight crimped; acc. to DIN 46228, Part 4/09.90; gray



**Item No.: 216-243**

Ferrule; Sleeve for 1 mm<sup>2</sup> / AWG 18; insulated; electro-tin plated; electrolytic copper; gastight crimped; acc. to DIN 46228, Part 4/09.90; red



**Item No.: 216-244**

Ferrule; Sleeve for 1.5 mm<sup>2</sup> / AWG 16; insulated; electro-tin plated; electrolytic copper; gastight crimped; acc. to DIN 46228, Part 4/09.90; black

## 1.2.4 Installation

### 1.2.4.1 Cover



**Item No.: 709-156**

Cover; Type 3; suitable for cover carrier, type 3; 1 m long; transparent

### 1.2.4.2 Cover carrier



**Item No.: 709-169**

Cover carrier; Type 3; incl. fixing/retaining screws and knurled nut; suitable for 279 to 282 and 880 Series rail-mounted terminal blocks; suitable for 264 Series miniature rail-mounted terminal blocks; suitable for 270 Series sensor and actuator terminal blocks; gray

## 1.2.5 Insulation stop

### 1.2.5.1 Insulation stop



**Item No.: 2001-171**

Insulation stop; 0.25 - 0.5 mm<sup>2</sup>; 5 pieces/strip; light gray

## 1.2.6 Jumper

### 1.2.6.1 Jumper



**Item No.: 2001-406/020-000**

Delta jumper; insulated; light gray



**Item No.: 2001-410**

Jumper; 10-way; insulated; light gray



**Item No.: 2001-402**

Jumper; 2-way; insulated; light gray



**Item No.: 2001-403**

Jumper; 3-way; insulated; light gray



**Item No.: 2001-404**

Jumper; 4-way; insulated; light gray



**Item No.: 2001-405**

Jumper; 5-way; insulated; light gray



**Item No.: 2001-406**

Jumper; 6-way; insulated; light gray



**Item No.: 2001-407**

Jumper; 7-way; insulated; light gray



**Item No.: 2001-408**

Jumper; 8-way; insulated; light gray



**Item No.: 2001-409**

Jumper; 9-way; insulated; light gray



**Item No.: 2001-440**

Jumper; from 1 to 10; insulated; light gray



**Item No.: 2001-433**

Jumper; from 1 to 3; insulated; light gray



**Item No.: 2001-434**

Jumper; from 1 to 4; insulated; light gray



**Item No.: 2001-435**

Jumper; from 1 to 5; insulated; light gray



**Item No.: 2001-436**

Jumper; from 1 to 6; insulated; light gray



**Item No.: 2001-437**

Jumper; from 1 to 7; insulated; light gray



**Item No.: 2001-438**

Jumper; from 1 to 8; insulated; light gray



**Item No.: 2001-439**

Jumper; from 1 to 9; insulated; light gray



**Item No.: 2001-405/011-000**

Star point jumper; 3-way; insulated; light gray



**Item No.: 2006-499**

Step-down jumper; from 2006/2004 to 2004/2002/2001 series; from 2206/2204 to 2204/2202/2201 series; insulated; light gray



**Item No.: 210-103**

Wire commoning chain; insulated; black



**Item No.: 210-123**

Wire commoning chain; insulated; blue

## 1.2.7 Marking

### 1.2.7.1 Marker



**Item No.: 793-4501/000-006**

WMB marking card; as card; stretchable 4 - 4.2 mm; plain; snap-on type; blue



**Item No.: 793-4501/000-007**

WMB marking card; as card; stretchable 4 - 4.2 mm; plain; snap-on type; gray



**Item No.: 793-4501/000-023**

WMB marking card; as card; stretchable 4 - 4.2 mm; plain; snap-on type; green



**Item No.: 793-4501/000-017**

WMB marking card; as card; stretchable 4 - 4.2 mm; plain; snap-on type; light green



**Item No.: 793-4501/000-012**

WMB marking card; as card; stretchable 4 - 4.2 mm; plain; snap-on type; orange



**Item No.: 793-4501/000-005**

WMB marking card; as card; stretchable 4 - 4.2 mm; plain; snap-on type; red



**Item No.: 793-4501/000-024**

WMB marking card; as card; stretchable 4 - 4.2 mm; plain; snap-on type; violet



**Item No.: 793-4501**

WMB marking card; as card; stretchable 4 - 4.2 mm; plain; snap-on type; white



**Item No.: 793-4501/000-002**

WMB marking card; as card; stretchable 4 - 4.2 mm; plain; snap-on type; yellow



**Item No.: 2009-114/000-006**

WMB-Inline; for Smart Printer; 2000 pieces on roll; stretchable 4 - 4.2 mm; plain; snap-on type; blue



**Item No.: 2009-114/000-007**

WMB-Inline; for Smart Printer; 2000 pieces on roll; stretchable 4 - 4.2 mm; plain; snap-on type; gray



**Item No.: 2009-114/000-023**

WMB-Inline; for Smart Printer; 2000 pieces on roll; stretchable 4 - 4.2 mm; plain; snap-on type; green



**Item No.: 2009-114/000-012**

WMB-Inline; for Smart Printer; 2000 pieces on roll; stretchable 4 - 4.2 mm; plain; snap-on type; orange



**Item No.: 2009-114/000-005**

WMB-Inline; for Smart Printer; 2000 pieces on roll; stretchable 4 - 4.2 mm; plain; snap-on type; red



**Item No.: 2009-114/000-024**

WMB-Inline; for Smart Printer; 2000 pieces on roll; stretchable 4 - 4.2 mm; plain; snap-on type; violet



**Item No.: 2009-114**

WMB-Inline; for Smart Printer; 2000 pieces on roll; stretchable 4 - 4.2 mm; plain; snap-on type; white



**Item No.: 2009-114/000-002**

WMB-Inline; for Smart Printer; 2000 pieces on roll; stretchable 4 - 4.2 mm; plain; snap-on type; yellow

### 1.2.7.2 Marking strip



**Item No.: 2009-110**

Marking strips; for Smart Printer; on reel; not stretchable; plain; snap-on type; white

## 1.2.8 Protective warning marker

### 1.2.8.1 Cover



**Item No.: 2001-115**

Protective warning marker; for 5 terminal blocks; with high-voltage symbol, black; yellow

## 1.2.9 Push-in type wire jumper

### 1.2.9.1 Jumper



**Item No.: 2009-414**

Push-in type wire jumper; 1.5 mm²; insulated; 110 mm long; black



**Item No.: 2009-414/000-005**

Push-in type wire jumper; 1.5 mm²; insulated; 110 mm long; black



**Item No.: 2009-416**

Push-in type wire jumper; 1.5 mm²; insulated; 250 mm long; black



**Item No.: 2009-414/000-006**

Push-in type wire jumper; insulated; 110 mm long; black



**Item No.: 2009-412**

Push-in type wire jumper; insulated; 60 mm long; black

## 1.2.10 Screwless end stop

### 1.2.10.1 Mounting accessories



**Item No.: 249-117**

Screwless end stop; 10 mm wide; for DIN-rail 35 x 15 and 35 x 7.5; gray



**Item No.: 249-116**

Screwless end stop; 6 mm wide; for DIN-rail 35 x 15 and 35 x 7.5; gray

## 1.2.11 Test and measurement

### 1.2.11.1 Testing accessories



**Item No.: 2001-560**

Modular TOPJOB®S connector; modular; for jumper contact slot; 10-pole; gray



**Item No.: 2001-511**

Modular TOPJOB®S connector; modular; for jumper contact slot; 1-pole; gray



**Item No.: 2001-552**

Modular TOPJOB®S connector; modular; for jumper contact slot; 2-pole; gray



**Item No.: 2001-553**

Modular TOPJOB®S connector; modular; for jumper contact slot; 3-pole; gray



**Item No.: 2001-554**

Modular TOPJOB®S connector; modular; for jumper contact slot; 4-pole; gray



**Item No.: 2001-555**

Modular TOPJOB®S connector; modular; for jumper contact slot; 5-pole; gray



**Item No.: 2001-556**

Modular TOPJOB®S connector; modular; for jumper contact slot; 6-pole; gray



**Item No.: 2001-557**

Modular TOPJOB®S connector; modular; for jumper contact slot; 7-pole; gray



**Item No.: 2001-558**

Modular TOPJOB®S connector; modular; for jumper contact slot; 8-pole; gray



**Item No.: 2001-559**

Modular TOPJOB®S connector; modular; for jumper contact slot; 9-pole; gray



**Item No.: 2001-549**

Spacer module; modular; e.g., for bridging commoned terminal blocks; gray



**Item No.: 2009-174**

Test plug adapter; for 4 mm Ø test plugs; for testing TOPJOB®S rail-mounted terminal blocks; gray



**Item No.: 2009-182**

Testing tap; for max. 2.5 mm²; tool-free connection for individual test wires 0.08 - 2.5 mm; gray

## 1.2.12 Tool

### 1.2.12.1 Operating tool



**Item No.: 210-719**

Operating tool; Blade: 2.5 x 0.4 mm; with a partially insulated shaft



**Item No.: 210-648**

Operating tool; Blade: 2.5 x 0.4 mm; with a partially insulated shaft; angled; short



**Item No.: 210-647**

Operating tool; Blade: 2.5 x 0.4 mm; with a partially insulated shaft; multicoloured

## Installation Notes

### Conductor termination



**All conductor types at a glance**

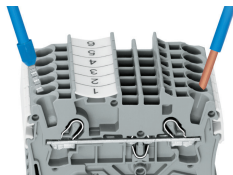

Push-in termination of solid and ferruled conductors

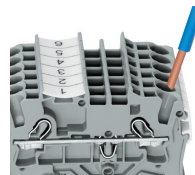

**Inserting a conductor via push-in termination:**

Solid conductors with cross-sections from either one size above, or up to two sizes below, the rated cross-section can be simply pushed in – no tools needed.

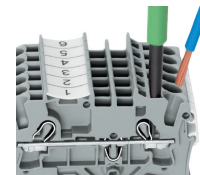

**Inserting a conductor via operating tool:**

Connecting fine-stranded conductors without ferrules, or small cross-sectional conductors that cannot be pushed in, is performed similarly to the original CAGE CLAMP® – just use an operating tool.

**Advantage:**

To open the clamp, the operating tool is inserted vertically. The conductor entry is less than 15 degrees for easier wiring.

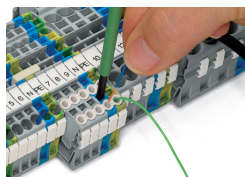

Conductor termination – insulation stop

### Commoning

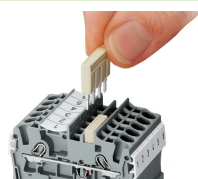

Insert push-in type jumper bar and push down until it hits backstop.

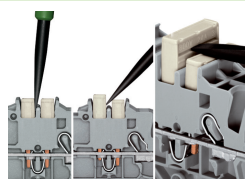

**Removing a push-in type jumper bar:**

Insert the operating tool between the jumper and partition wall of the dual jumper slots, then lift up the jumper.

Place the operating tool in the center of jumpers for up to five contacts (see above), or alternately on both sides for jumpers with more than five contacts.

Commoning

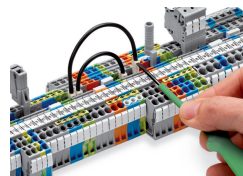
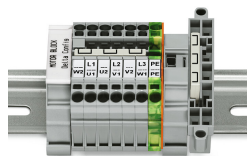
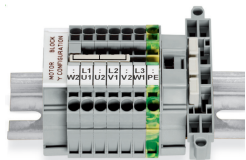

This star point jumper has been specially developed to create a "star point" and is used on motor terminal boards equipped with Rail-Mount Terminal Blocks TOPJOB® S.

This delta jumper has been specially developed to create a delta configuration and is used on motor terminal boards equipped with rail-mount terminal blocks TOPJOB® S.

Push down the wire jumper until fully inserted. Lift the jumper with an operating tool for rewiring.

Commoning

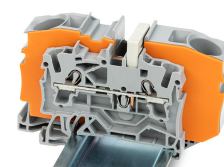
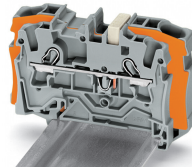
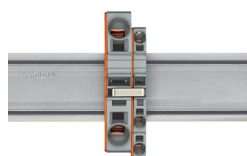
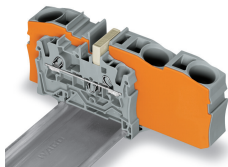

Step-down jumpers common terminal blocks of different sizes, without losing a conductor clamping point. This can be beneficial on long conductor runs where voltage drop can be a problem. A large conductor can be easily connected to smaller conductors at the distribution point. Commoning may be made in either direction using the special thin end plate to cover the open side. Additional through terminal blocks having a smaller cross-section may be commoned using push-in type jumper bars.

**Using step-down jumpers**, an end plate must be inserted between the terminal blocks to be commoned.

**Step-down jumper (Item No. 2006-499)** commons 6/4 mm<sup>2</sup> (10/12 AWG) terminal blocks (2006/2004 Series) with 4/2.5/1.5 mm<sup>2</sup> (AWG 12/14/16) terminal blocks (2004/2002/2001 Series).

**Step-down jumper (Item No. 2016-499)** commons 16/10 mm<sup>2</sup> (16/8 AWG) terminal blocks (2016/2010 Series) with 10/6/4/2.5 mm<sup>2</sup> (8/10/12/14 AWG) terminal blocks (2010/2006/2004/2002 Series).

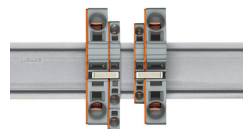
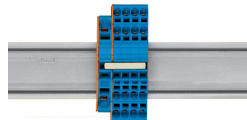
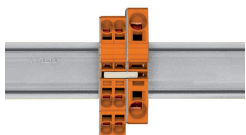

**Stepping down via push-in type jumper bar:**  
Commoning via open terminal side with end plate allows jumpering over two cross-section sizes for 16 mm<sup>2</sup> (6 AWG) and 10 mm<sup>2</sup> (8 AWG) and one cross-section size for 6/4/2.5 mm<sup>2</sup> (10/12/14 AWG). An example: from 16 mm<sup>2</sup> (6 AWG) to 6 mm<sup>2</sup> (10 AWG) (see illustration above) or from 10 mm<sup>2</sup> (8 AWG) to 4 mm<sup>2</sup> (12 AWG).

**Stepping down via push-in type jumper bar:**  
Commoning via closed terminal side with end plate allows jumpering over two cross-section sizes, e.g., from 16 mm<sup>2</sup> (6 AWG) to 6 mm<sup>2</sup> (10 AWG) or from 6 mm<sup>2</sup> (10 AWG) to 2.5 mm<sup>2</sup> (14 AWG) (see illustration above).

**Note:**  
The total current of the outgoing circuits must not exceed the nominal current of the step-down jumper/push-in type jumper bar.

Testing

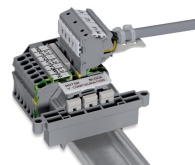
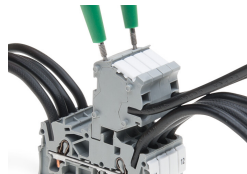
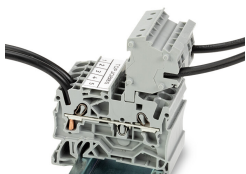

The modular TOPJOB® S connectors also connect conductors of the same size as the terminal blocks being used.

TOPJOB® S Connectors with a 2 mm Ø test socket for testing voltage via 2-pole voltage tester

Rail-mount terminal block assembly for electric motor wiring

Test plug adapter (Item No. 2009-174, CAT II) for 4 mm Ø plugs – compatible with 2000 to 2016 Series

Testing



Testing tap (Item No. 2009-182) for tool-free connection of test cables up to 2.5 mm<sup>2</sup> (12 AWG) – compatible with 2000 to 2016 Series

Marking

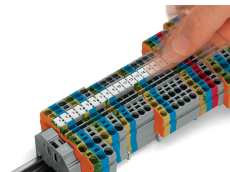

Snapping WMB Inline markers into marker slots.

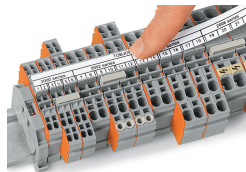

TOPJOB® S 2009-193 Group Marker Carrier (equipped with a marking strip) for all 2001 to 2016 Series TOPJOB® S Rail-Mount Terminal Blocks  
Do not use on an end plate!



Ex application

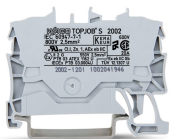

Through terminal blocks with a blue insulated housing are suitable for Ex i applications.

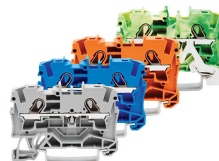
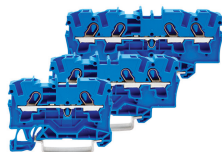

All through and ground conductor terminal blocks are suitable for Ex e II applications.

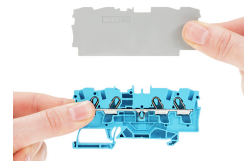

**Separator plate for Ex e/Ex i applications**

An end plate must be applied to the terminal block located directly behind an Ex e/Ex i separator plate.

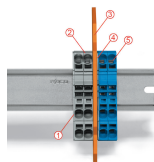

**Ex e II/Ex i terminal strip**

**Note:**  
The movable feet of terminal blocks and separator plates must face the same direction.

A separator plate is located between the Ex e II and Ex i terminal strip.  
End plate  
Ex e II terminal blocks  
Separator plate for Ex e/Ex i applications  
End plate  
Ex i terminal blocks  
According to EN 50020, a minimum distance of 50 mm must be kept between live parts of Ex e and Ex i circuits. The use of Ex e/Ex i separators is a space-saving solution when Ex e and Ex i terminal blocks are mounted on a common DIN-rail.