



Exiway Trend

The ideal choice for all applications

se.com/en

Life Is On

Schneider
Electric

Exiway Trend

From recessed to false ceiling installations with an attractive design even on surface applications.



Wireless connection

Activa-link models with radio frequency communication and remote monitoring through APP Facility Expert SB



Configurable light level

From 50 to 500lm, 4 configurable autonomies (1h/ 1,5h / 2h/ 3h) and Maintained and Not Maintained mode selectable by jumpers



Exit sign function

Vetrosignal Kit (25m) or adhesive pictograms (20m) for all directions



Different installations

Maximum flexibility of use. Recessed, surface, ceiling and false ceiling

Exiway Trend models

Standard



Self-contained luminaire operating in emergency mode with manual verification of the functionality.

FEATURE



Emergency

Activa



Self-testing luminaires: technology makes it possible to carry out periodic and automatic tests of the single luminaire signaling any anomalies via a multicolored LED. Reduction of verification times thanks to the automatic tests.

FEATURE



Emergency

Activa-link



Self-contained luminaire with periodic and automatic tests but also remotely monitoring of the status through the Facility Expert Small Business APP. Real-time notifications in case of failures and digital report downloadable from everywhere at any time.

FEATURE



Emergency

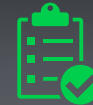
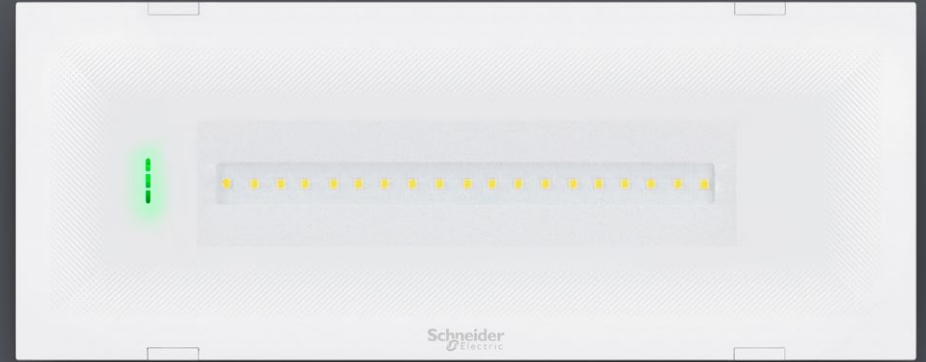

Self - test



Self - test



Remote Monitoring and digital reporting

Monitor from everywhere your Emergency Lighting system

Exiway Trend Activa-link works with Facility Expert SB

Luminaires communicate with each other in radio frequency creating a mesh network.
Each Exiway Trend Activa-link works as a repeater ensuring robust propagation of the signal.



Not only Emergency Lighting



PowerTag Ambient
Temperature sensor



PowerTag Energy
Energy sensor



PowerTag Control
Control module



PowerTag Link C+



Router Internet



Schneider Electric
Secure Server

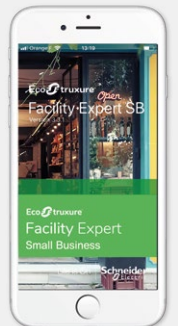

The APP Facility Expert Small Business allows you to:

- receive notifications in real time
- download the report of your Emergency Lighting system

Maximum efficiency and time saving

Exiway Trend Activa-link

The status of the Activa-link luminaires is always available remotely through the Facility Expert SB APP. You also receive notifications in real time.



Facility Expert SB



Real time notifications on the APP in case of failure

Digital report downloadable in any moment from everywhere

E-mail with details of failures



Protect your safety with timely repairs and preventative management

Your professional support for monitoring your emergency lighting system

The electrician is your partner for the maintenance of the system

Owner

Thanks to the APP, your trusted electrician is delegated by you to manage and monitor the emergency lighting system.



Digital report

The trusted electrician is always updated on the status of the system by e-mail with:

- digital report of the system
- detail of the failures of each luminaire



Electrician

The on site operation is reduced to minimum. Information in real time allows the electrician to save time.



Regulations

The report helps you to be compliant with the regulations. It keeps track of the tests done and can be attached to the safety logbook.

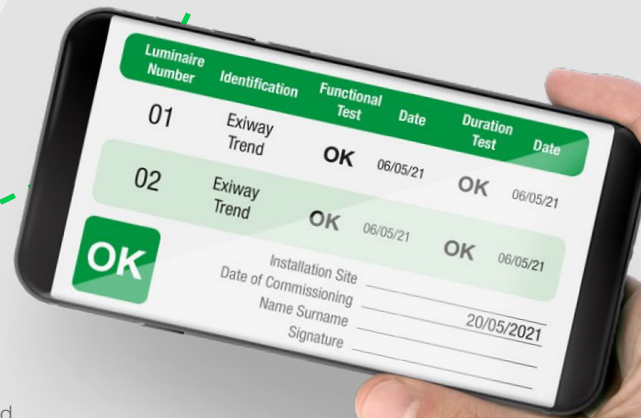
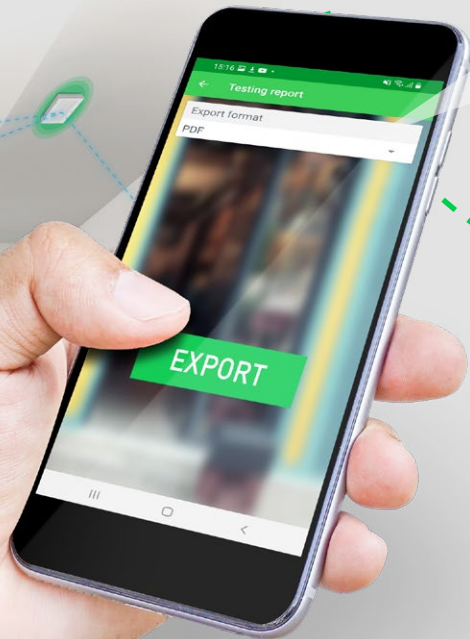

Luminaire Number	Identification	Functional Test	Date	Duration Test	Date
01	Exiway Trend	OK	06/05/21	OK	06/05/21
02	Exiway Trend	OK	06/05/21	OK	06/05/21

OK

Installation Site _____
Date of Commissioning _____
Name Surname _____
Signature _____ 20/05/2021

up to
500 lm



Choose your light level

1 reference 5 performances

Multi-performance range to choose the required function just before installing the product

Simple and versatile range. 3 models cover 15 different performances. Autonomy can be selected: standard autonomy is 1 hour, but can be increased to 1.5, 2 or 3 hours depending on the project specifications. Each reference includes maintained/non-maintained function, M/SA maintained mode (always ON), NM/SE non-maintained mode (only emergency), selection can be done from jumper.

	1h	1,5h	2h	3h	Maintained
Trend 110	110	90	70	50	70
Trend 250	250	200	150	120	150
Trend 500	500	400	300	250	230

values in Lumen



Maint./Non-maint. Jumper

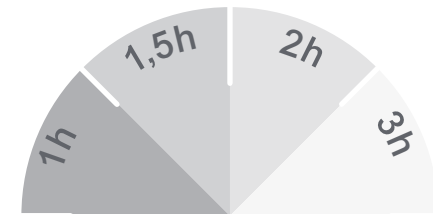

Autonomy Jumper

Exit sign function

Vetrosignal kit or set of adhesive pictograms



Vetrosignal kit Left/Right (Ref. OVA53230)
Vetrosignal kit Down/Down (Ref. OVA53231)
(25m)



Set of 4 Pictograms (20m) for surface installations (Ref. OVA53229)

Perfectly integrated with an attractive design



Stylish screen
with a modern design

Meets the aesthetics
and regulations needs



Surface installation



Surface installation
with optional frame (Ref. OVA53184)

Fast mounting

Only 2 steps to install the luminaire

7 entry cable

4 lateral and 3 on the back

Frame

accessory for a smooth look of the product in surface installations



Screwless connector

In the Activa-link models for a faster and more reliable installation. Detachable connector easy to handle for Standard versions.

2

Only 2 elements to assemble for a quick installation



Quick fastener coupling reflector



Quick screen fastener hooks

Easy maintenance

Battery replacement in a short time

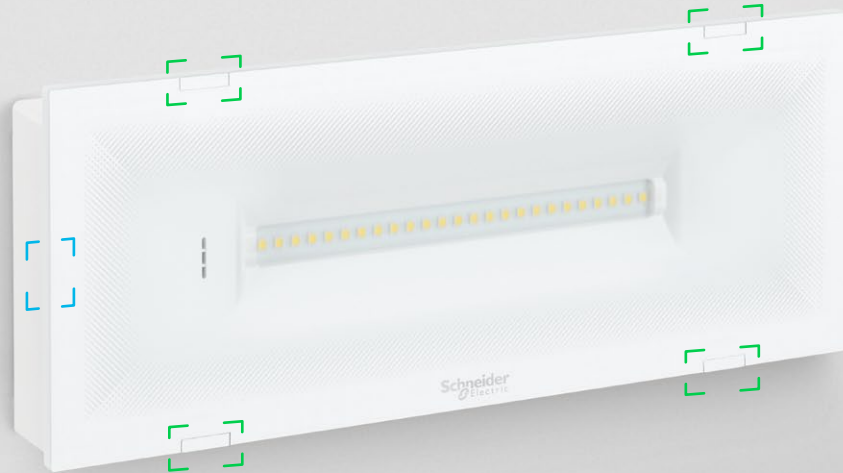

Frontal opening
In any installation

1

2

**Reflector and screen
join together**
for a quick release

3

Quick connector
to replace the battery



Environment friendly

Inspire green ambitions

High efficiency LEDs

No photobiological risk in accordance with EN 62471
Risk Group Zero

Eco-compatible materials

The packaging is fully recyclable and more than 40% of the plastic parts are made of recycled material



Battery LiFePO4

Increased energy efficiency, lower and higher temperature tolerance. Does not contain hazardous materials



New Green Premium layout, recycled carton environmentally friendly



Complies with the European Regulations and is ENEC Certified

EN 60598-2-22 / EN 62034
EN 62471



Green Premium products comply with RoHS and REACH standards. We greatly surpass regulatory requirements thanks to the gradual replacement of certain materials and substances used in our products.

Exiway Trend

Technical Features

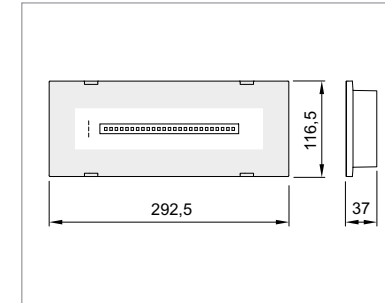

- Protection rating: IP42/IK08 and IP65/IK09
- Entry cable or tubes up to 16 mm Ø
- Standard, Activa and Activa-link models
- Activa-link compatible with PowerTag Link C+ (Ref. A9XELC10)
- Insulation Class II
- Compliant with EN 60598-2-22 EN 62471 Group RG0
- Installation even on flammable surface
- Working temperature 0° + 40°C
- Mains: 230 V 50 Hz
- Batteries LiFePO4
- Maintained (M/SA) and Non-Maintained (NM/SE) function available from jumper position
- Activa-link models with maintained connector for remote switch (the jumper must remain in the Maintained position)
- Incandescent wire 850° C (60695-2-10)
- Self-extinguishing Polycarbonate 94 V-2 (UL94)
- Light source: Long life LED (up to 100,000 h)
- Multiple autonomies 1h, 1.5h, 2h and 3h selectable from a dedicated jumper
- Complete recharge 12 h
- Certification ENEC

Product dimensions



Photometric diagram

Catalogue - Commercial references

	IP / IK	Operation	Emergency flux (lm)*				Maint. Flux (lm)	Model	Description	Reference
			1h	1.5h	2h	3h				
💡 Standard										
	42 / 08	NM-M	110	90	70	50	70	Trend 110	Exiway Trend Standard IP42 110 1/1,5/2/3h NM/M	OVA47010
			250	200	150	120	150	Trend 250	Exiway Trend Standard IP42 250 1/1,5/2/3h NM/M	OVA47012
			500	400	300	250	230	Trend 500	Exiway Trend Standard IP42 500 1/1,5/2/3h NM/M	OVA47014
	65 / 09	NM-M	110	90	70	50	70	Trend 110	Exiway Trend Standard IP65 110 1/1,5/2/3h NM/M	OVA47011
			250	200	150	120	150	Trend 250	Exiway Trend Standard IP65 250 1/1,5/2/3h NM/M	OVA47013
			500	400	300	250	230	Trend 500	Exiway Trend Standard IP65 500 1/1,5/2/3h NM/M	OVA47015
Standard compatible with TBS Remote control 150										
	65 / 09	NM-M	250	200	150	120	150	Trend 250 TBS	Exiway Trend Standard IP65 250 1/1,5/2/3h NM/M TBS	OVA47019
🗣️ Activa										
	42 / 09	NM-M	110	90	70	50	70	Trend 110	Exiway Trend Activa IP42 110 1/1,5/2/3h NM/M	OVA47110
			250	200	150	120	150	Trend 250	Exiway Trend Activa IP42 250 1/1,5/2/3h NM/M	OVA47112
			500	400	300	250	230	Trend 500	Exiway Trend Activa IP42 500 1/1,5/2/3h NM/M	OVA47114
	65 / 09	NM-M	110	90	70	50	70	Trend 110	Exiway Trend Activa IP65 110 1/1,5/2/3h NM/M	OVA47111
			250	200	150	120	150	Trend 250	Exiway Trend Activa IP65 250 1/1,5/2/3h NM/M	OVA47113
			500	400	300	250	230	Trend 500	Exiway Trend Activa IP65 500 1/1,5/2/3h NM/M	OVA47115
🗣️ Activa-link **										
	42 / 08	NM-M	110	90	70	50	70	Trend 110	Exiway Trend Activa-link IP42 110 1/1,5/2/3h NM/M	OVA47210
			250	200	150	120	150	Trend 250	Exiway Trend Activa-link IP42 250 1/1,5/2/3h NM/M	OVA47212
			500	400	300	250	230	Trend 500	Exiway Trend Activa-link IP42 500 1/1,5/2/3h NM/M	OVA47214
	65 / 09	NM-M	110	90	70	50	70	Trend 110	Exiway Trend Activa-link IP65 110 1/1,5/2/3h NM/M	OVA47211
			250	200	150	120	150	Trend 250	Exiway Trend Activa-link IP65 250 1/1,5/2/3h NM/M	OVA47213
			500	400	300	250	230	Trend 500	Exiway Trend Activa-link IP65 500 1/1,5/2/3h NM/M	OVA47215

* Flux according to EN 60598-2-22 Standard requirements. The emergency flux changes according to the selected autonomy.

All Exiway Trend products are Quality certified  and comply with EN 62471 standard requirements.

Accessories

+ Exit Sign accessories for both surface and ceiling installation



Vetosignal kit
25m

Ref. OVA53230 - Left/Right
Ref. OVA53231 - Down/Down



Adhesive pictograms
20m

Ref. OVA53229



+ Mounting accessories for recessed and ceiling installations



Recessed mounting box
Ref. OVA53119



Frame
Ref. OVA53184



Fixing screws for recessed
box in the ceiling
Ref. OVA53131



Frame with
spring fixing
Ref. OVA53120

+ Remote Controller TBS 150

Compatible
with ref. OVA47019

Ref. OVA53161



+ Gateway PowerTag Link C+

For connecting Exiway Trend Activa-link
to the Facility Expert Small Business system

Ref. A9XELC10



Flexible installation

Exiway Trend + Accessories

Recessed

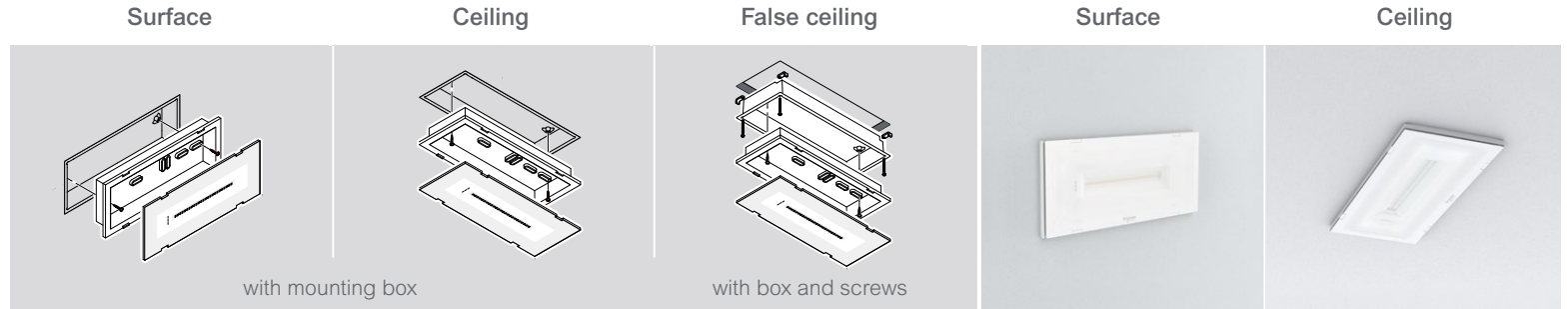

Recessed for drywall

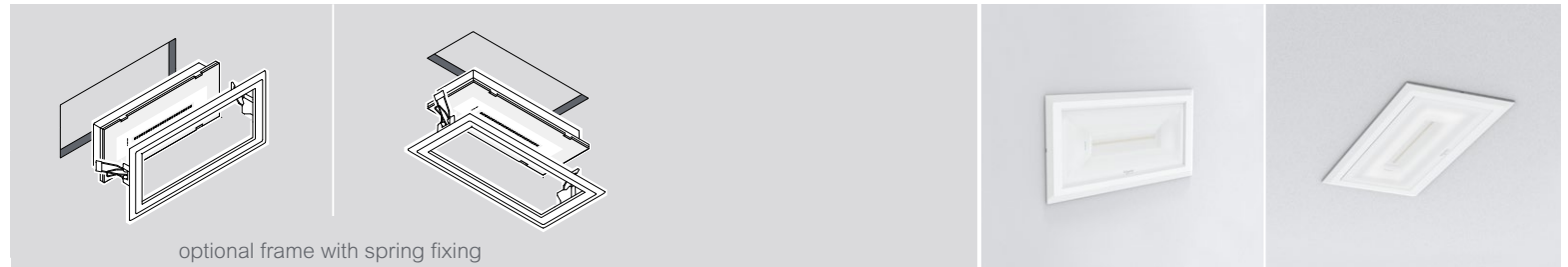

Surface

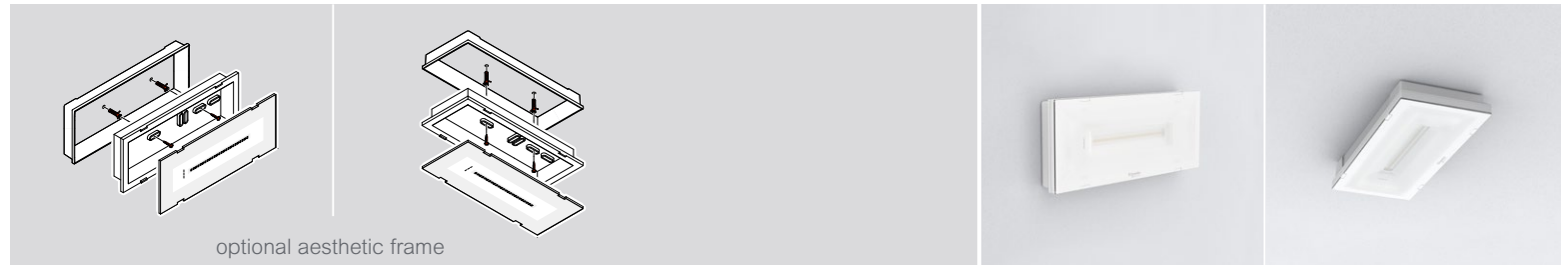



... the ideal choice for all applications

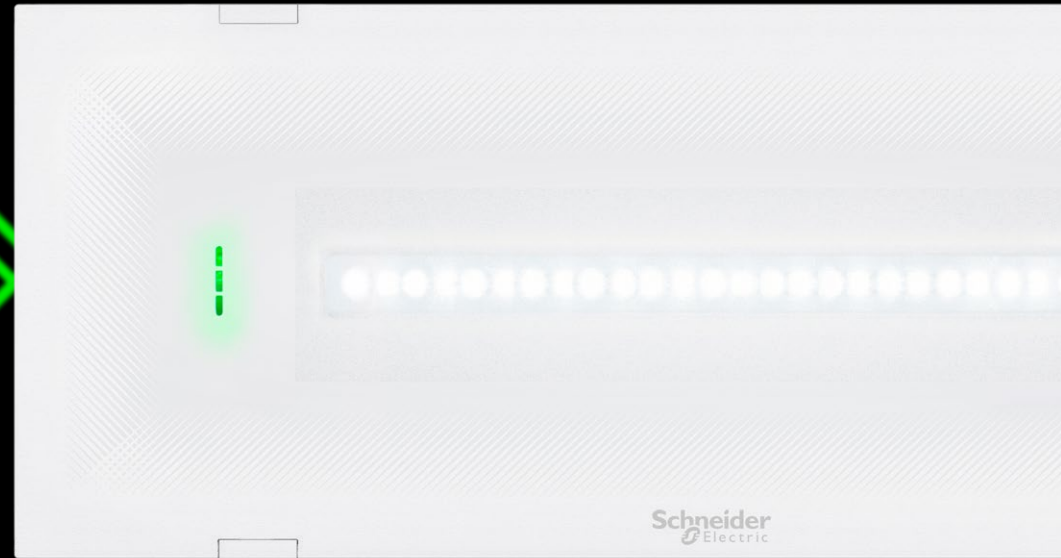

Schneider Electric SE
35 rue Joseph Monier
92500 Rueil Malmaison - France
www.schneider-electric.com

Life Is On

Schneider
Electric