

intercable

Datasheet Plaatkabelschoen Stift 4,0-6,0mm²

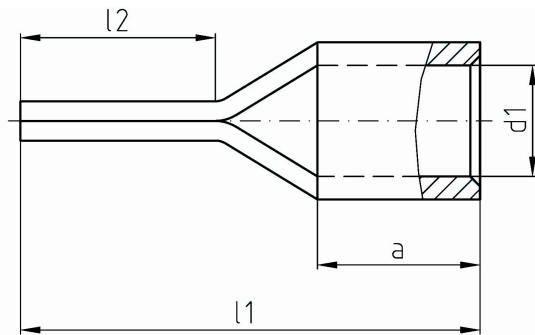

Artikelnummer	ICQ6ST
Doorsnede Kabel	4,0-6,0 mm ²
Materiaal	CU-HCP 99,95% vlgns DIN EN 13600
Afwerking	Galvanisch vertind

Maten:

D1	3.6mm
L1	20mm
L2	11mm
A	6mm
Ø Stift	2.6mm
Gewicht	0.15 kg/100