

**Data Sheet | Item Number: 750-531**  
 4-channel digital output; 24 VDC; 0.5 A; 2-conductor connection

<https://www.wago.com/750-531>

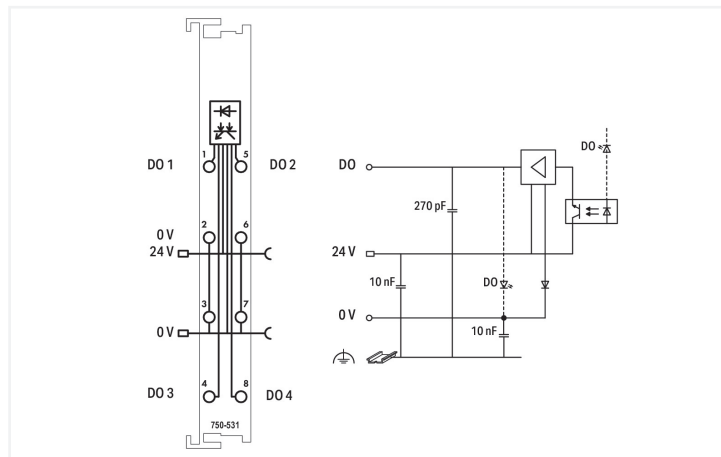

Color: ■ light gray

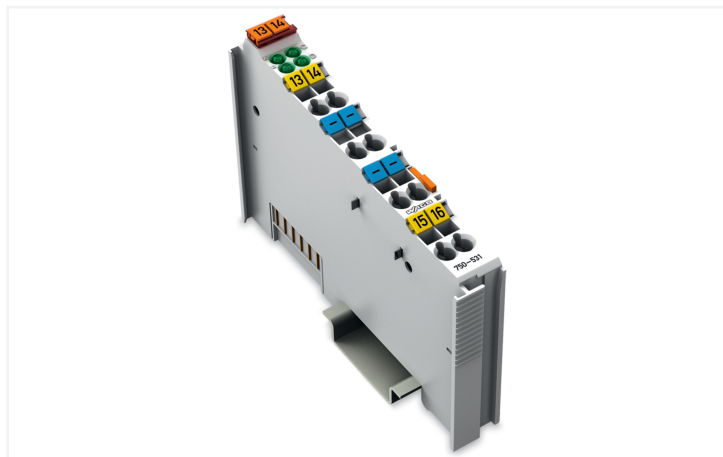
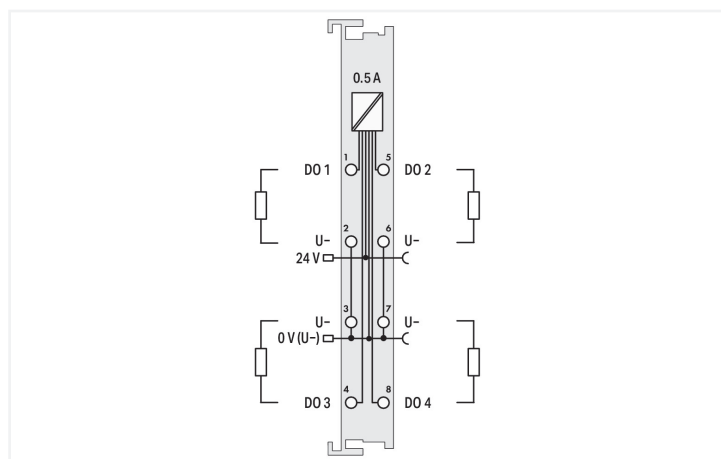
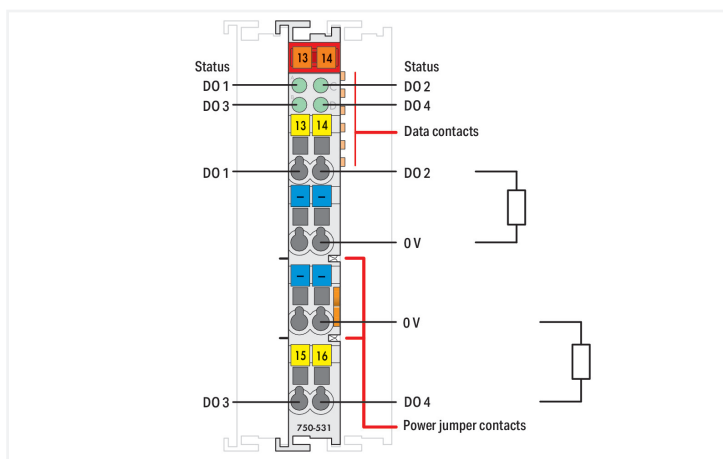

This digital output module transmits control signals from the automation device to the connected actuators. The module has four output channels and four 0 V outputs, providing a direct connection to four 2-wire actuators. All outputs are short-circuit-protected. Field and system levels are electrically isolated.

Technical data	
Number of digital outputs	4
Total number of channels (module)	4
Signal type	Digital
Signal type (voltage)	24 VDC
Actuator connection	4 x (2-wire)
Output characteristic	high-side switching
Output current per channel	0.5 A
Output current	short-circuit-protected
Load type	Resistive, inductive, lamp load
Short-circuit current	1.7 A
Reverse voltage protection	Yes
Switching frequency (max.)	1 kHz
Inductive load switch-off energy dissipation (max.)	0.3 J
Output data width (internal) max.	4 bits

### Technical data

Supply voltage (system)	5 VDC; via data contacts
Current consumption (5 V system supply)	10 mA
Supply voltage (field)	24 VDC (-25 ... +30 %); via power jumper contacts (power supply via blade contact; transmission (field side supply voltage only) via spring contact)
Current consumption, field supply (module with no external load)	30 mA
Isolation	500 V system/field
Indicators	LED (A-D) green: Status DO 1 ... DO 4
Number of incoming power jumper contacts	2
Number of outgoing power jumper contacts	2
Current carrying capacity (power jumper contacts)	10 A

### Connection Data

Connection technology: I/O	8 x CAGE CLAMP® (outputs)
Connectable conductor materials	Copper
Connection type	Output
Solid conductor	0.08 ... 2.5 mm <sup>2</sup> / 28 ... 14 AWG
Fine-stranded conductor	0.08 ... 2.5 mm <sup>2</sup> / 28 ... 14 AWG
Strip length	8 ... 9 mm / 0.31 ... 0.35 inches

### Physical data

Width	12 mm / 0.472 inches
Height	100 mm / 3.937 inches
Depth	69.8 mm / 2.748 inches
Depth from upper-edge of DIN-rail	62.6 mm / 2.465 inches

### Mechanical data

Mounting type	DIN-35 rail
Pluggable connector	fixed

### Material data

Color	light gray
Housing material	Polycarbonate; polyamide 6.6
Fire load	0.706 MJ
Weight	49.4 g
Conformity marking	CE

### Environmental requirements

Ambient temperature (operation)	0 ... +55 °C
Ambient temperature (storage)	-40 ... +85 °C
Protection type	IP20
Pollution degree	2 per IEC 61131-2
Operating altitude	0 ... 2000 m / 0 ... 6562 ft
Mounting position	Horizontal left, horizontal right, horizontal top, horizontal bottom, vertical top and vertical bottom
Relative humidity (without condensation)	95 %
Vibration resistance	4g per IEC 60068-2-6
Shock resistance	15g per IEC 60068-2-27
EMC immunity to interference	per EN 61000-6-2, marine applications
EMC emission of interference	per EN 61000-6-4, marine applications
Exposure to pollutants	per IEC 60068-2-42 and IEC 60068-2-43
Permissible H <sub>2</sub> S contaminant concentration at a relative humidity 75 %	10 ppm
Permissible SO <sub>2</sub> contaminant concentration at a relative humidity 75 %	25 ppm

### Commercial data

Product Group	15 (I/O System)
PU (SPU)	1 pcs
Packaging type	Box
Country of origin	DE
GTIN	4045454513733
Customs tariff number	85371098990

### Product Classification

UNSPSC	32151705
eCl@ss 10.0	27-24-26-04
eCl@ss 9.0	27-24-26-04
ETIM 9.0	EC001599
ETIM 10.0	EC001599
ECCN	NO US CLASSIFICATION

### Environmental Product Compliance

CAS-No.	1303-86-2 1317-36-8 7439-92-1 75980-60-8
REACH Candidate List Substance	Diboron trioxide Lead Lead monoxide Phosphine oxide, diphenyl(2,4,6-trimethylbenzoyl)-
RoHS Compliance Status	Compliant,With Exemption
RoHS Exemption	6(c) 7(a) 7(c)-I 7(c)-II
SCIP notification number (Austria)	8cc076f8-a785-429b-9f60-d5660e624484
SCIP notification number (Belgium)	e760e06d-7044-4832-81c3-30b868a5586a
SCIP notification number (Bulgaria)	69102fad-362e-458c-98b4-c1aaf7bc9b06
SCIP notification number (Czech Republic)	681c635a-fb7f-49eb-99df-7f6c9b64906b
SCIP notification number (Denmark)	ea3d9c60-6bda-4565-8789-e5a1163691ea
SCIP notification number (Finland)	da818926-f2ef-46bb-83f7-657a374fb531
SCIP notification number (France)	70df5f42-1ec5-42cb-b771-d871286a0566
SCIP notification number (Germany)	0e6f8c11-bec8-4bde-bde3-4539a134535c
SCIP notification number (Hungary)	e578b753-2cfe-4111-8db3-41665180c222
SCIP notification number (Italy)	a238c6aa-b606-4992-bd50-d1e98632378c
SCIP notification number (Netherlands)	7e2290e6-a30a-4228-9e58-66e4d8a5968a
SCIP notification number (Poland)	16556ce0-97e3-410c-8ffb-287f22712764
SCIP notification number (Romania)	9a5311eb-2d8b-4cdd-a15c-4eb0c1ef7a68
SCIP notification number (Sweden)	4013297a-3f60-4493-be6d-56d62b4d0c60

### Approvals / Certificates

#### General approvals



Approval	Standard	Certificate Name
EAC GZO Almaty Standart	TP TC 020/2011	EAC CoC 03083
KC National Radio Research Agency	Article 58-2, Clause 3	MSIP-REM-W43-DOM750

#### Declarations of conformity and manufacturer's declarations

Approval	Standard	Certificate Name
EU-Declaration of Conformity WAGO GmbH & Co. KG	-	-
UK-Declaration of Conformity WAGO GmbH & Co. KG	-	-

Approvals for marine applications



Approval	Standard	Certificate Name
ABS American Bureau of Ship- ping	-	22-2219060
BSH Bundesamt fuer See- schifffahrt und Hydrogra- phie	-	1104
BV Bureau Veritas S.A.	-	13453/E0 BV
DNV DNV GL SE	DNV-CG-0339, Aug. 2021	TAA0000194
KR Korean Register of Ship- ping	-	KR HMB05880-AC001
LR Lloyds Register EMEA	-	LR22180952TA
NK Nippon Kaiji Kyokai	Guidel. Perform. Type Ap- provals	TA25276M
PRS Polski Rejestr Statków	-	TE/1101/880590/23
RINA RINA Germany GmbH	-	ELE343521XG001

Approvals for hazardous areas



Approval	Standard	Certificate Name
ATEX TUEV Nord Cert GmbH	EN 60079-0	TUEV14ATEX148929X (II 3 G Ex ec IIC T4 Gc)
CCCEX CQST/CNEx	CNCA-C23-01	2020312310000213 (Ex ec IIC T4 Gc)
INMETRO TUV Rheinland do Brasil Ltda.	IEC 60079-0	TUV 12.1297 X
UKEx WAGO GmbH & Co. KG	EN 60079-0	UKCA_WA GO22UKEX003X_ec
UL Underwriters Laboratories Inc. (HAZARDOUS LOCA- TIONS)	UL 121201	E198726

Downloads

Environmental Product Compliance

Compliance Search
Environmental Product Compliance 750-531 <a href="#">↓</a>

Documentation

Manual			
Product Manual 4- channel, 24VDC, 0.5A	2510460299   2   en-US   2025-07-01 13:00 03.09.2025	pdf 974.75 KB	<a href="#">↓</a>
System Manual Series 750/753			<a href="#">↓</a>

System Description		
750/753 Series I/O- System – General Pro- duct Information		pdf 953.35 KB <a href="#">↓</a>
Overview on WAGO-I/ O-SYSTEM 750 appro- vals		pdf 770.48 KB <a href="#">↓</a>

Bid Text			
750-531	11.07.2017	doc 28.50 KB	<a href="#">↓</a>
750-531	19.02.2019	xml 4.23 KB	<a href="#">↓</a>

Instruction Leaflet			
CCC Ex (Additional in- formation)	26.04.2023	pdf 159.76 KB	<a href="#">↓</a>

## Application Notes

Application note, other

pdf  
2174.17 KB



## CAD/CAE-Data

CAD data

2D/3D Models 750-531



CAE data

EPLAN Data Portal  
750-531



WSCAD Universe  
750-531



ZUKEN Portal 750-531



## Device Files

Device Driver

WAGO USB Service Ka- 6.5.3.0 zip  
bel Treiber / Serie 750 10.09.2014 4721.96 KB  
und 857



## 1 Compatible Products

### 1.1 Optional Accessories

#### 1.1.1 DIN-rail

##### 1.1.1.1 Mounting accessories



**Item No.: 210-196**

Aluminum carrier rail; 35 x 8.2 mm; 1.6 mm thick; 2 m long; unslotted; similar to EN 60715; silver-colored



**Item No.: 210-198**

Copper carrier rail; 35 x 15 mm; 2.3 mm thick; 2 m long; unslotted; according to EN 60715; copper-colored



**Item No.: 210-197**

Steel carrier rail; 35 x 15 mm; 1.5 mm thick; 2 m long; slotted; similar to EN 60715; silver-colored



**Item No.: 210-114**

Steel carrier rail; 35 x 15 mm; 1.5 mm thick; 2 m long; unslotted; similar to EN 60715; silver-colored



**Item No.: 210-118**

Steel carrier rail; 35 x 15 mm; 2.3 mm thick; 2 m long; unslotted; according to EN 60715; silver-colored



**Item No.: 210-115**

Steel carrier rail; 35 x 7.5 mm; 1 mm thick; 2 m long; slotted; according to EN 60715; "Hole width 18 mm; silver-colored



**Item No.: 210-112**

Steel carrier rail; 35 x 7.5 mm; 1 mm thick; 2 m long; slotted; according to EN 60715; "Hole width 25 mm; silver-colored



**Item No.: 210-113**

Steel carrier rail; 35 x 7.5 mm; 1 mm thick; 2 m long; unslotted; according to EN 60715; silver-colored

### 1.1.2 Marking









#### 1.1.2.1 Group marker carrier



**Item No.: 750-106**

Group marker carrier

1.1.2.2 Marker

 <p><b>Item No.: 750-100</b> Marker card; as a DIN A4 sheet; plain</p>	<p><b>Item No.: 2009-145/000-006</b> Mini-WSB Inline; for Smart Printer; 1700 pieces on roll; stretchable 5 - 5.2 mm; plain; snap-on type; blue</p>	<p><b>Item No.: 2009-145/000-007</b> Mini-WSB Inline; for Smart Printer; 1700 pieces on roll; stretchable 5 - 5.2 mm; plain; snap-on type; gray</p>	<p><b>Item No.: 2009-145/000-023</b> Mini-WSB Inline; for Smart Printer; 1700 pieces on roll; stretchable 5 - 5.2 mm; plain; snap-on type; green</p>
<p><b>Item No.: 2009-145/000-012</b> Mini-WSB Inline; for Smart Printer; 1700 pieces on roll; stretchable 5 - 5.2 mm; plain; snap-on type; orange</p>	<p><b>Item No.: 2009-145/000-005</b> Mini-WSB Inline; for Smart Printer; 1700 pieces on roll; stretchable 5 - 5.2 mm; plain; snap-on type; red</p>	<p><b>Item No.: 2009-145/000-024</b> Mini-WSB Inline; for Smart Printer; 1700 pieces on roll; stretchable 5 - 5.2 mm; plain; snap-on type; violet</p>	<p><b>Item No.: 2009-145</b> Mini-WSB Inline; for Smart Printer; 1700 pieces on roll; stretchable 5 - 5.2 mm; plain; snap-on type; white</p>
<p><b>Item No.: 2009-145/000-002</b> Mini-WSB Inline; for Smart Printer; 1700 pieces on roll; stretchable 5 - 5.2 mm; plain; snap-on type; yellow</p>	 <p><b>Item No.: 248-501/000-006</b> Mini-WSB marking card; as card; not stretchable; plain; snap-on type; blue</p>	 <p><b>Item No.: 248-501/000-007</b> Mini-WSB marking card; as card; not stretchable; plain; snap-on type; gray</p>	 <p><b>Item No.: 248-501/000-023</b> Mini-WSB marking card; as card; not stretchable; plain; snap-on type; green</p>
 <p><b>Item No.: 248-501/000-017</b> Mini-WSB marking card; as card; not stretchable; plain; snap-on type; light green</p>	 <p><b>Item No.: 248-501/000-012</b> Mini-WSB marking card; as card; not stretchable; plain; snap-on type; orange</p>	 <p><b>Item No.: 248-501/000-005</b> Mini-WSB marking card; as card; not stretchable; plain; snap-on type; red</p>	 <p><b>Item No.: 248-501/000-024</b> Mini-WSB marking card; as card; not stretchable; plain; snap-on type; violet</p>
 <p><b>Item No.: 248-501</b> Mini-WSB marking card; as card; not stretchable; plain; snap-on type; white</p>	 <p><b>Item No.: 248-501/000-002</b> Mini-WSB marking card; as card; not stretchable; plain; snap-on type; yellow</p>		

1.1.2.3 Marker carrier

 <p><b>Item No.: 750-103</b> Group marker carrier</p>
--

1.1.3 Shield termination

1.1.3.1 Shield clamping saddles

 <p><b>Item No.: 790-108</b> Shield clamping saddle; 11 mm wide; diameter of compatible conductor; 3 ... 8 mm</p>	 <p><b>Item No.: 790-208</b> Shield clamping saddle; 12.4 mm wide; 3 ... 8 mm</p>	 <p><b>Item No.: 790-116</b> Shield clamping saddle; 19 mm wide; diameter of compatible conductor; 7 ... 16 mm</p>	 <p><b>Item No.: 790-216</b> Shield clamping saddle; 21.8 mm wide; 6 ... 16 mm</p>
 <p><b>Item No.: 790-124</b> Shield clamping saddle; 27 mm wide; diameter of compatible conductor; 6 ... 24 mm</p>	 <p><b>Item No.: 790-220</b> Shield clamping saddle; 30 mm wide; 6 ... 20 mm</p>	 <p><b>Item No.: 790-140</b> Shield clamping saddle; diameter of compatible conductor</p>	

### 1.1.4 Supply module

#### 1.1.4.1 Supply module



**Item No.: 750-612**

Power Supply; 0 ... 230 V AC/DC

**Item No.: 750-602**

Power Supply; 24 VDC

**Item No.: 750-601**

Power Supply; 24 VDC; fuse holder

**Item No.: 750-610**

Power Supply; 24 VDC; fuse holder; Diagnostics

### 1.1.5 System enclosure

#### 1.1.5.1 System enclosure



**Item No.: 850-825**

IP65 enclosure; Aluminium (RAL 7032); WxHxD (160x100x160 mm); 9 x M12, 4 x M20

**Item No.: 850-826**

IP65 enclosure; Aluminium (RAL 7032); WxHxD (240x100x160 mm); 4 x M20, 4 x M16, 14 x M12 cable grip

**Item No.: 850-827**

IP65 enclosure; Aluminium (RAL 7032); WxHxD (320x100x160 mm); 4 x M20, 8 x M16, 17 x M12 cable grip

**Item No.: 850-828**

IP65 enclosure; Aluminium (RAL 7032); WxHxD (480x100x160 mm); 4 x M20, 10 x M16, 35 x M12 cable grip



**Item No.: 850-826/002-000**

IP65 enclosure; Aluminium (RAL 7035); WxHxD (240x100x160 mm); 4 x M20, 4 x M16, 14 x M12 cable grip

**Item No.: 850-827/002-000**

IP65 enclosure; Aluminium (RAL 7035); WxHxD (320x100x160 mm); 4 x M20, 8 x M16, 17 x M12 cable grip

**Item No.: 850-828/002-000**

IP65 enclosure; Aluminium (RAL 7035); WxHxD (480x100x160 mm); 4 x M20, 10 x M16, 35 x M12 cable grip

**Item No.: 850-834**

IP65 enclosure; Polyester (RAL 7032); WxHxD (164x100x164 mm); 9 x M12, 4 x M20



**Item No.: 850-835**

IP65 enclosure; Polyester (RAL 7032); WxHxD (244x100x164 mm); 4 x M20, 4 x M16, 14 x M12 cable grip

**Item No.: 850-836**

IP65 enclosure; Polyester (RAL 7032); WxHxD (324x100x164 mm); 4 x M20, 8 x M16, 17 x M12 cable grip

**Item No.: 850-814/002-000**

IP65 enclosure; Sheet steel (RAL 7035); WxHxD (200x120x200 mm); without flange plate

**Item No.: 850-815/002-000**

IP65 enclosure; Sheet steel (RAL 7035); WxHxD (300x120x200 mm); without flange plate



**Item No.: 850-816/002-000**

IP65 enclosure; Sheet steel (RAL 7035); WxHxD (400x120x200 mm); without flange plate

**Item No.: 850-817/002-000**

IP65 enclosure; Sheet steel (RAL 7035); WxHxD (600x120x200 mm); without flange plate