

Data Sheet | Item Number: 222-500

Mounting carrier; 222 Series; for DIN-35 rail mounting/screw mounting; orange

<https://www.wago.com/222-500>

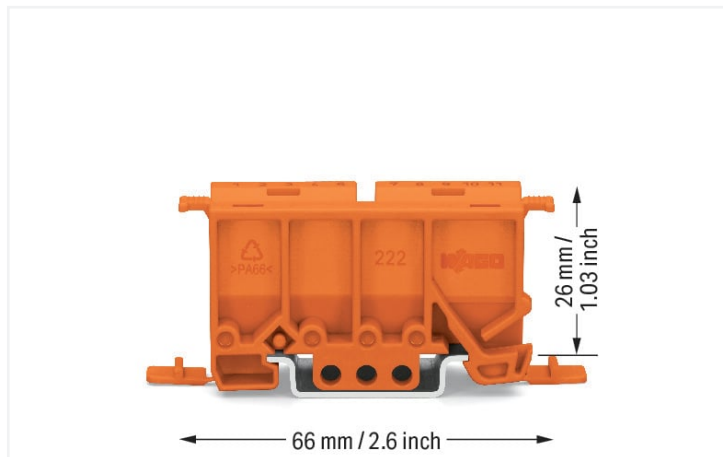

Color: ■ orange

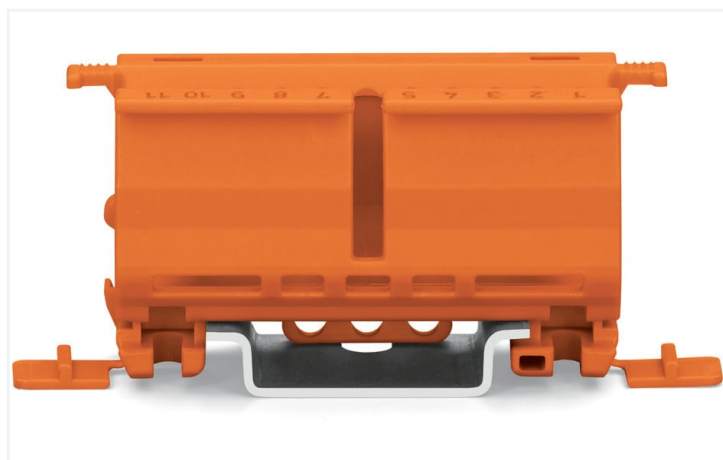

Physical data

Width	22 mm / 0.866 inches
Height	66 mm / 2.598 inches
Depth from upper-edge of DIN-rail	26 mm / 1.024 inches

Mechanical data

Mounting type	DIN-35 rail Screw mount
Suitable	for 2-, 3- and 5-conductor splicing connectors (222 Series)

Material data

Note (material data)	Information on material specifications can be found here
Color	orange
Material group	I
Insulation material	Polyamide (PA66)
Flammability class per UL94	V0
Fire load	0.336 MJ
Weight	11.2 g

Commercial data	
Product Group	7 (Push Wire Conn.)
eCl@ss 10.0	27-14-11-92
eCl@ss 9.0	27-14-11-92
ETIM 8.0	EC002848
ETIM 7.0	EC002848
PU (SPU)	50 (10) pcs
Packaging type	Box
Country of origin	CN
GTIN	4045454714765
Customs tariff number	39269097900

Environmental Product Compliance	
RoHS Compliance Status	Compliant, No Exemption

Downloads

Environmental Product Compliance

Compliance Search	
Environmental Product Compliance 222-500	↓

Documentation

Bid Text			
222-500	19.02.2019	xml 2.73 KB	↓
222-500	19.05.2017	doc 23.50 KB	↓

CAD/CAE-Data

CAD data	
2D/3D Models 222-500	↓

CAE data	
EPLAN Data Portal 222-500	↓
WSCAD Universe 222-500	↓
ZUKEN Portal 222-500	↓

1 Compatible Products

1.1 Optional Accessories

1.1.1 Marking

1.1.1.1 Marking strip



Item No.: 210-834

Marking strips; on reel; 5 mm wide; plain;
Self-adhesive; white

1.1.2 Mounting adapter

1.1.2.1 Mounting accessories



Item No.: 222-510

Angled DIN-rail adapter; in combination
with mounting carrier; 221-500 or
222-500; for DIN-35 rail mounting; gray



Item No.: 222-505

Strain relief plate; for mounting carrier;
221 or 222 Series, can be snapped

Installation Notes



Snapping the lateral connector safety
lock onto the mounting carrier.



Securing a strain relief plate (222-505) to
the mounting carrier.

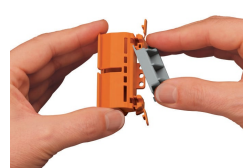

Snapping the angled DIN-rail adapter
(222-510) onto the mounting carrier.



Horizontal mounting on DIN-35 rail using
an angled DIN-rail adapter

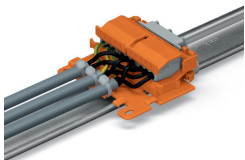

Horizontal mounting with strain relief plate
on DIN-35 rail using an angled DIN-rail ad-
apter

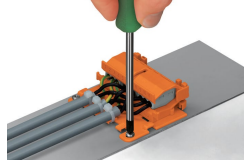

Horizontal screw mounting with strain re-
lief plate on a flat surface



Vertical mounting with strain relief plate
on DIN-35 rail;
Marking clamping units via marking
strips.

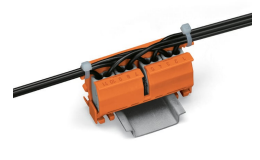

Strain relief via cable ties on the mounting
carrier (transverse to the connectors' wi-
ring direction);
Molded marking clamping units

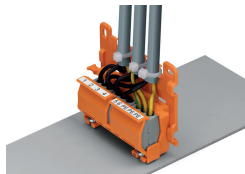

Mounting carrier with strain relief plate
mounted vertically on a plate.
Round cable secured via strain relief lug.