

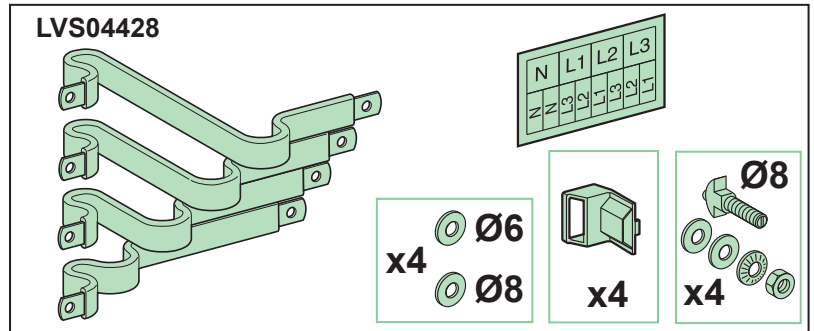

en fr es de it pt zh ru

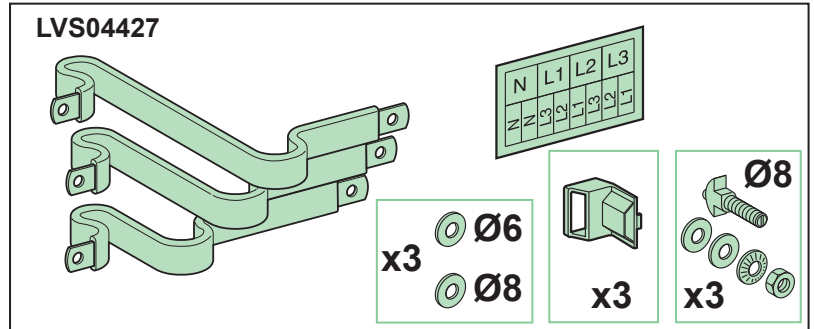
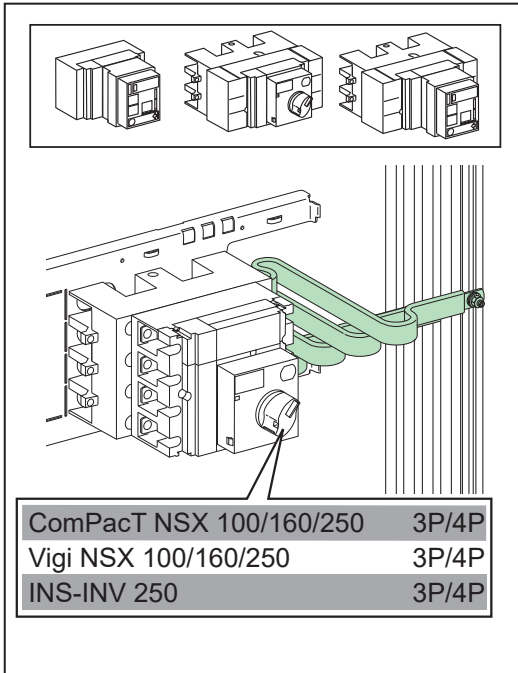

<p>PLEASE NOTE Electrical equipment should be installed, operated, serviced, and maintained only by qualified personnel. No responsibility is assumed by Schneider Electric for any consequences arising out of the use of this material.</p>	<p>REMARQUE IMPORTANTE L'installation, l'utilisation, la réparation et la maintenance des équipements électriques doivent être assurées uniquement par du personnel qualifié. Schneider Electric décline toute responsabilité quant aux conséquences de l'utilisation de ce matériel.</p>	<p>TENGA EN CUENTA La instalación, manejo, puesta en servicio y mantenimiento de equipos eléctricos deberán ser realizados sólo por personal cualificado. Schneider Electric no se hace responsable de ninguna de las consecuencias del uso de este material.</p>	<p>BITTE BEACHTEN Elektrische Geräte dürfen nur von Fachpersonal installiert, betrieben, bedient und gewartet werden. Schneider Electric haftet nicht für Schäden, die durch die Verwendung dieses Materials entstehen.</p>
<p>NOTA Manutenzione, riparazione, installazione e uso delle apparecchiature elettriche si devono affidare solo a personale qualificato. Schneider Electric non si assume alcuna responsabilità per qualsiasi conseguenza derivante dall'uso di questo materiale.</p>	<p>NOTA A instalação, utilização e manutenção do equipamento eléctrico devem ser efectuadas exclusivamente por pessoal qualificado. A Schneider Electric não assume qualquer responsabilidade pelas consequências resultantes da utilização deste material.</p>	<p>请注意 电气设备的安装、操作、维修和维护工作仅限于合格人员执行。Schneider Electric 不承担由于使用本资料所引起的任何后果。</p>	<p>ОБРАТИТЕ ВНИМАНИЕ Установка, эксплуатация, ремонт и обслуживание электрического оборудования может выполняться только квалифицированными электриками. Компания Schneider Electric не несет никакой ответственности за любые возможные последствия использования данной документации.</p>

⚠️ DANGER / DANGER / PELIGRO / GEFAHR / PERICOLO / PERIGO / 危险 / ОПАСНО

<p>HAZARD OF ELECTRIC SHOCK, EXPLOSION, OR ARC FLASH</p> <ul style="list-style-type: none"> Disconnect all power before servicing equipment. Always use a properly rated voltage sensing device to confirm that all power is off. <p>Failure to follow these instructions will result in death or serious injury.</p>	<p>RISQUE D'ÉLECTROCUTION, D'EXPLOSION OU D'ARC ÉLECTRIQUE</p> <ul style="list-style-type: none"> Coupez toutes les alimentations avant de travailler sur cet appareil. Vérifiez toujours que toutes les alimentations sont coupées à l'aide d'un dispositif de détection de tension approprié. <p>Si ces directives ne sont pas respectées, cela entraînera la mort ou des blessures graves.</p>	<p>PELIGRO DE DESCARGA ELÉCTRICA, EXPLOSIÓN O ARCO ELÉCTRICO</p> <ul style="list-style-type: none"> Desconecte todas las alimentaciones antes de manipular el producto. Per verificare che l'alimentazione sia isolata usare sempre un rilevatore di tensione correttamente tarato. <p>El incumplimiento de estas instrucciones podrá causar la muerte o lesiones serias.</p>	<p>GEFAHR VON ELEKTRISCHEM SCHLAG, EXPLOSION ODER LICHTBOGEN</p> <ul style="list-style-type: none"> Vor dem Arbeiten am Gerät alle Spannungsversorgungen abschalten. Verwenden Sie stets ein Spannungsprüfgerät mit der korrekten Bemessungsspannung, um festzustellen, ob die Spannungsversorgung wirklich abgeschaltet ist. <p>Die Nichtbeachtung dieser Anweisungen führt zu Tod oder schweren Verletzungen.</p>
<p>RISCHIO DI SCARICA ELETTRICA, ESPLOSIONE O ARCO ELETTRICO</p> <ul style="list-style-type: none"> Scollegare l'apparecchio da tutti i circuiti di alimentazione prima di qualsiasi intervento. Per verificare che l'alimentazione sia isolata usare sempre un rilevatore di tensione correttamente tarato. <p>Il mancato rispetto di queste istruzioni provocherà morte o gravi infortuni.</p>	<p>RISCO DE ELECTROCUSSÃO, DE EXPLOSAÇÃO, OU DE ARCO ELÉCTRICO</p> <ul style="list-style-type: none"> Desconecte todas as alimentações antes de manipular o produto. Utilize sempre um dispositivo de detecção da tensão nominal adequada para confirmar se a alimentação está desligada. <p>A não observância destas instruções resultará em morte, ou ferimentos graves.</p>	<p>电击、爆炸或弧闪的危险</p> <ul style="list-style-type: none"> 在此电力设备上工作时请先切断所有电源。 确保使用合适的额定电压传感器确认电源已关闭。 <p>不遵循上述说明将导致人员伤亡。</p>	<p>Опасность поражением электрическим током, опасность взрыва или вспышки дуги</p> <ul style="list-style-type: none"> Перед обслуживанием или ремонтом убедитесь, что питание отключено. Чтобы убедиться в отключении питания, обязательно используйте тестер надлежащего номинала. <p>Несоблюдение этих инструкций приведет к смерти или серьезной травме</p>

A

LVS04427

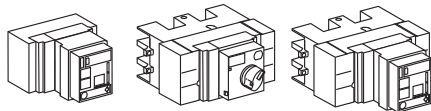

LVS04428

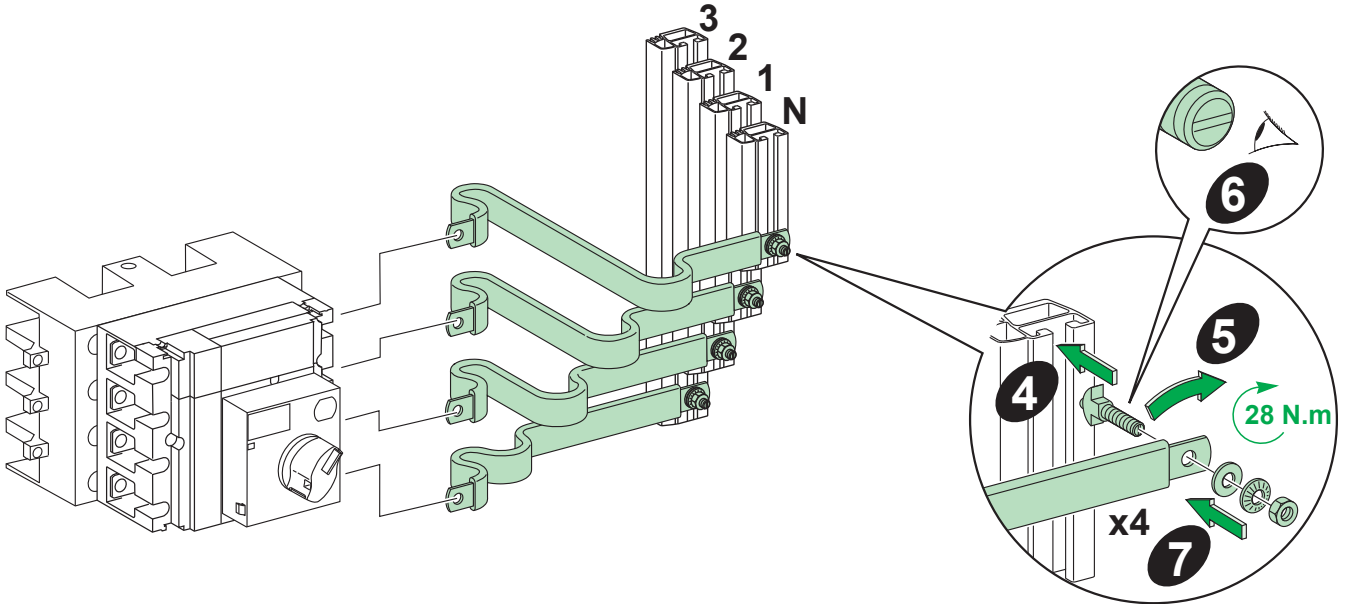
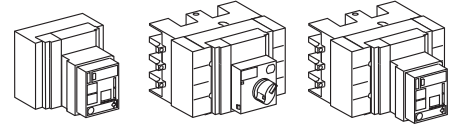
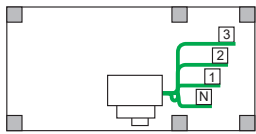
**A'**

LVS04427

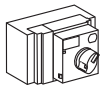

LVS04428

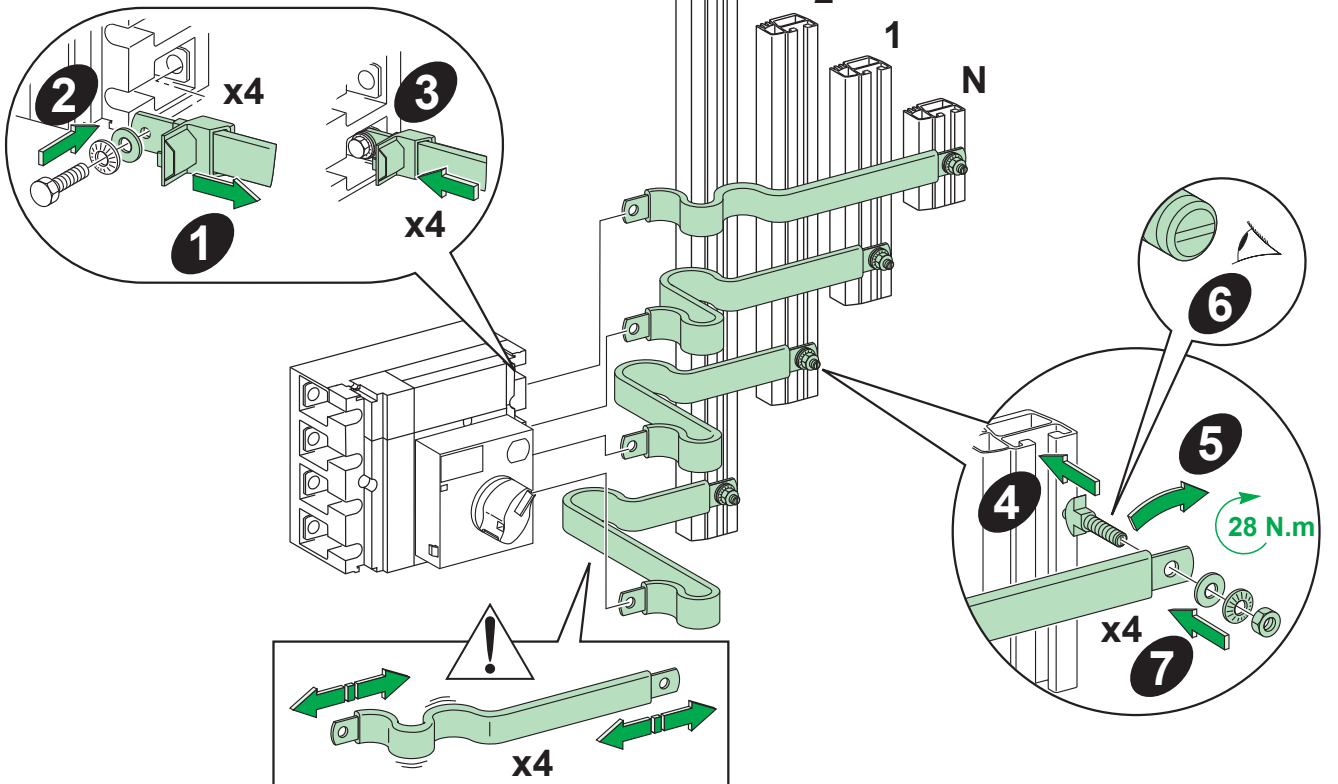
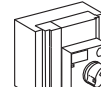

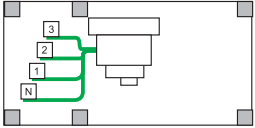
B

LVS04427

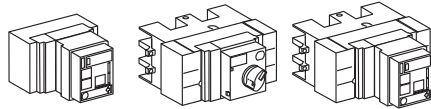

LVS04428

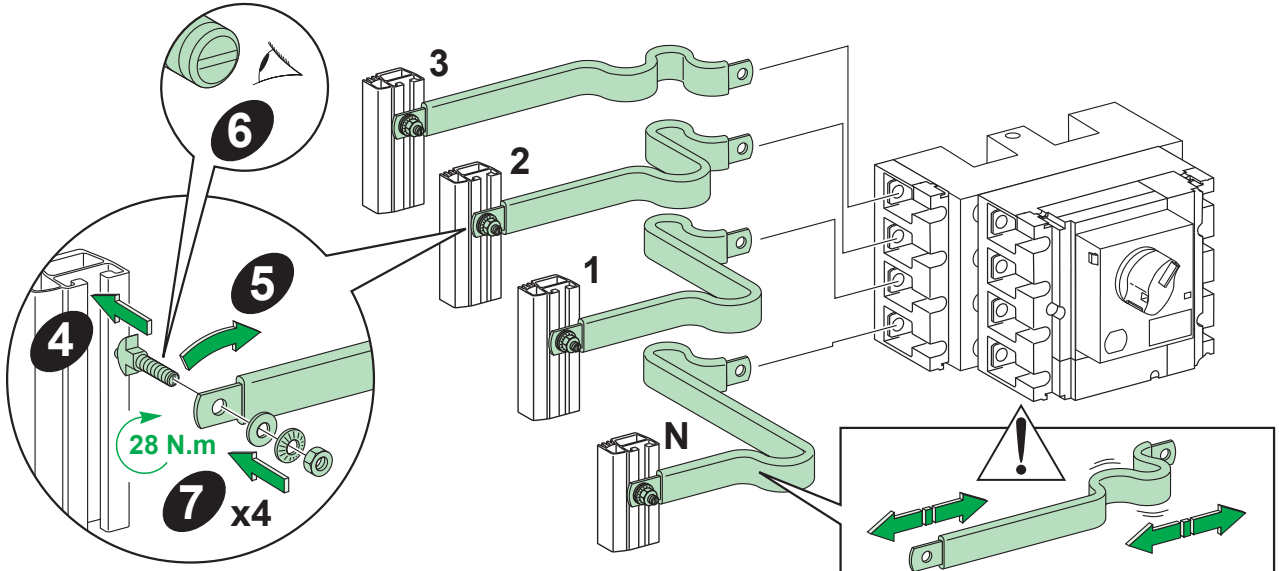
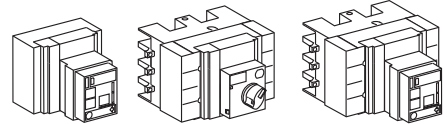
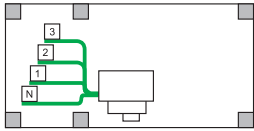
**B'**

LVS04427

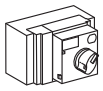

LVS04428

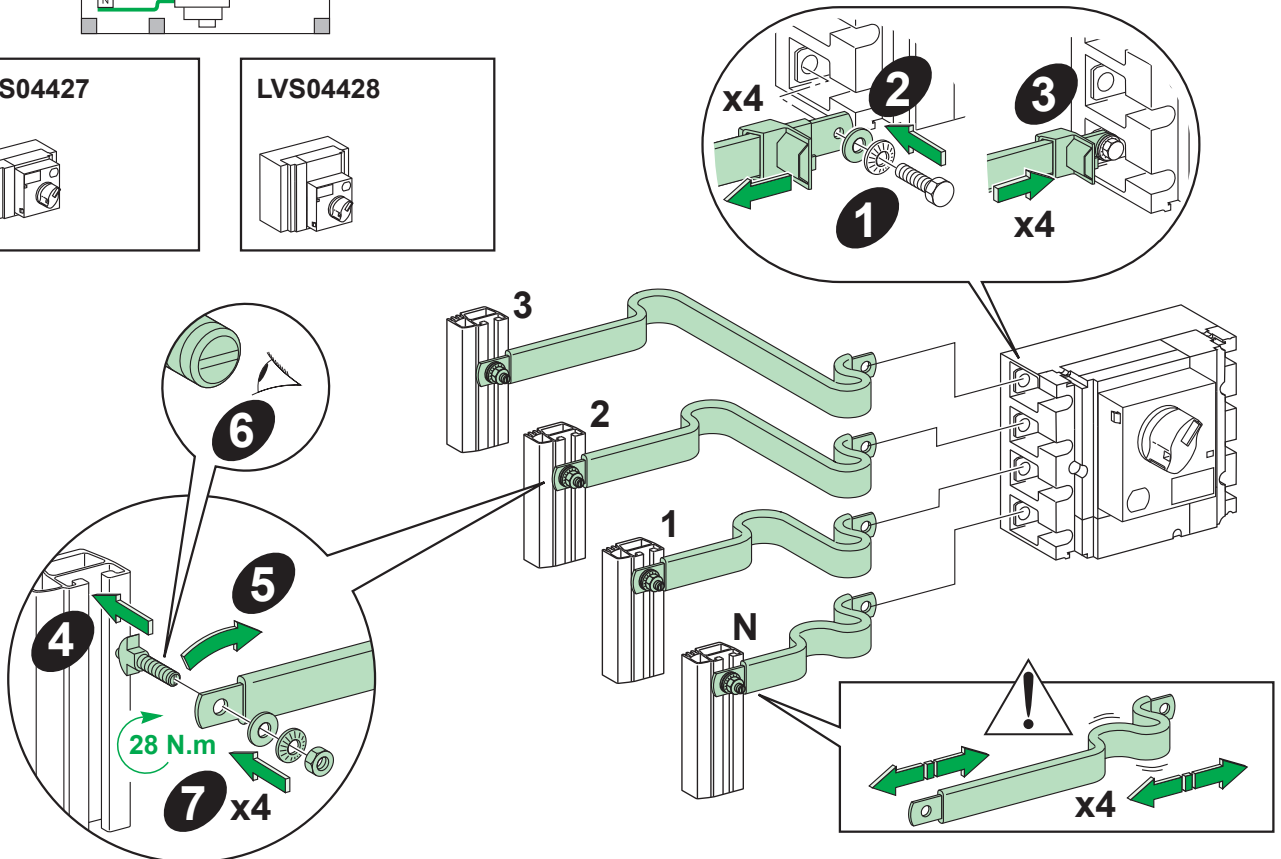
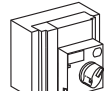



1

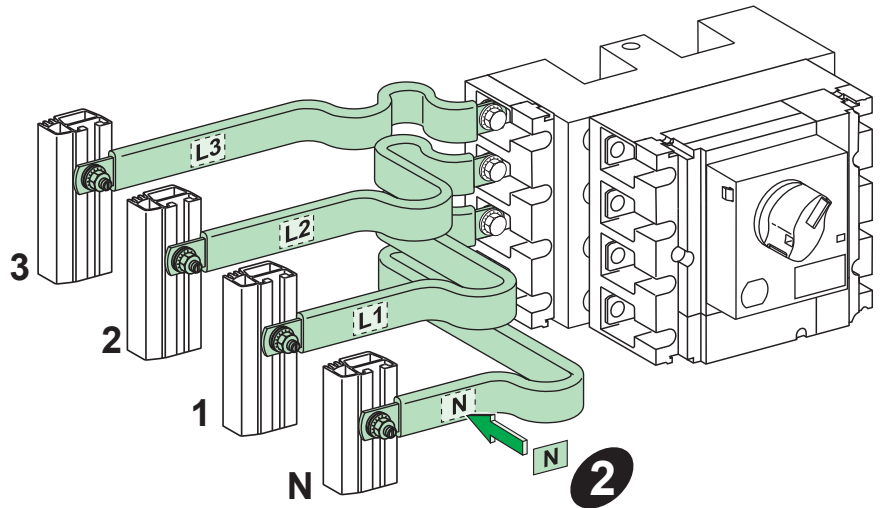
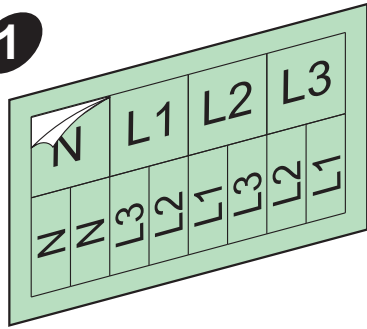

PrismaSeT



LVS04794

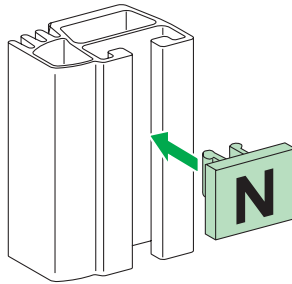

PrismaSeT



LVS04766

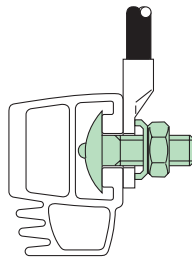

Schneider Electric Industries SAS
 35, rue Joseph Monier
 92500 Rueil-Malmaison
 France

www.se.com

En raison de l'évolution des normes et du matériel, les caractéristiques indiquées par le texte et les images de ce document ne nous engageant qu'après confirmation par nos services.

As standards, specifications and designs change from time to time, please ask for confirmation of the information given in this publication.

Publication : Schneider Electric
 Réalisation : Schneider Electric
 Impression :
 Format de pliage : 210 x 297 mm



Ce document a été imprimé sur du papier écologique.

This document has been printed on ecological paper.

Schneider Electric Limited
 Stafford Park 5
 Telford, TF3 3BL
 United Kingdom
 www.se.com/uk

