

intercable

Datasheet Plaatkabelschoen Stift 50mm²

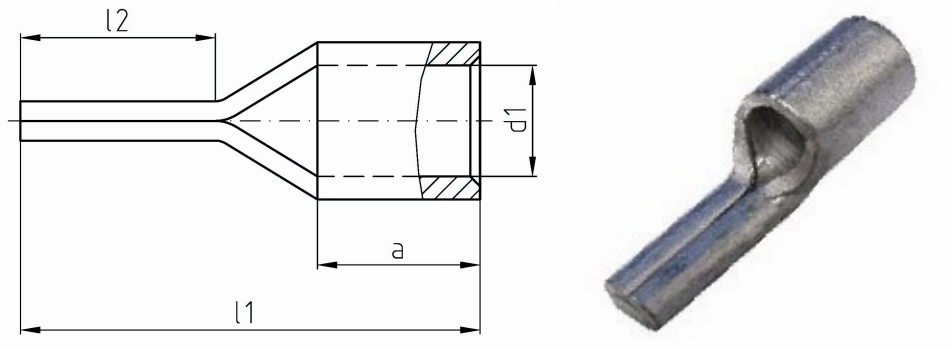

Artikelnummer	ICQ50ST*
Doorsnede Kabel	50 mm ²
Materiaal	CU-HCP 99,95% vlgns DIN EN 13600
Afwerking	Galvanisch vertind

Maten:

D1	9.5mm
L1	45.7mm
L2	21mm
A	19mm
Ø Stift	3,7 x 9,5mm
Gewicht	1.89 kg/100