

Valena™ Next
2-wire automatic switch 100 VA LED
3-wire automatic switch 500 VA LED

Cat. No(s): 7 415 61A/62A - 7 417 61A/62A - 7 419 61A/62A
 7 415 60A - 7 417 60A - 7 419 69A

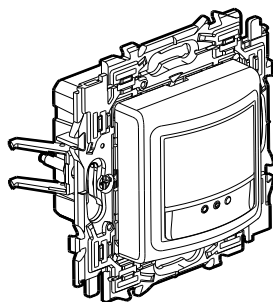

1. USE

Universal automatic switches, with or without neutral, with infrared detection.
 Allow automatic control of a light source by detection of movement in their surveillance zone.
 Replace use of a traditional mechanical switch.
 Recessed mounting in box depth 30 mm minimum.
 Screw and/or claw fixing.

2. RANGE

■ **2.1 2-wire automatic switch without neutral 100 VA LED**

7 415 62A	White	2-wire automatic switch, without override Supplied with support frame and cover plate To be equipped with finishing plate
7 419 62A	Matte White	
7 417 62A	Black	
7 415 61A	White	2-wire automatic switch, with override Supplied with support frame and cover plate To be equipped with finishing plate
7 419 61A	Matte White	
7 417 61A	Black	

■ **2.2 3-wire automatic switch without neutral 500 VA LED**

7 415 60A	White	2-wire automatic switch, without override Supplied with support frame and cover plate To be equipped with finishing plate
7 419 69A	Matte White	
7 417 60A	Black	

3. DIMENSIONS (mm)

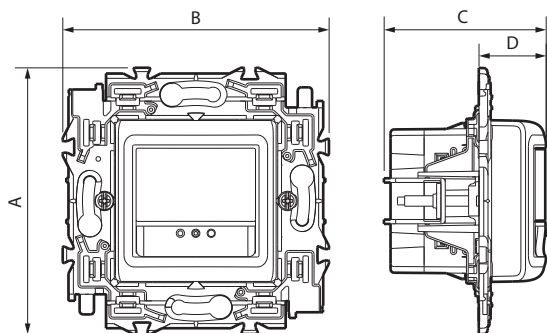

A	B	C	D
74	74	45	19

4. CONNECTION

Terminal type: with screws
 Terminal capacity: 2 x 1.5 mm² - 1 x 2.5 mm²
 Stripping length: 8 mm
 Screwdriver: flat 4 mm

5. DESCRIPTION

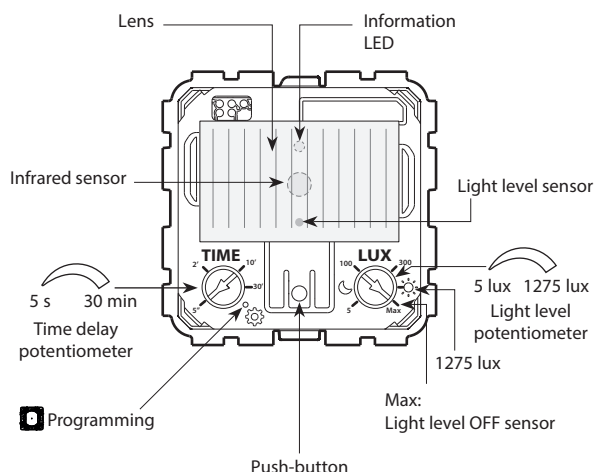

6. TECHNICAL CHARACTERISTICS

- **6.1 General characteristics**
 Motion detectors with 170° detection angle.
 Detection range: 8 m max.
- **6.2 Mechanical characteristics**
 Impact tests: IK 04
 Protection against solid bodies and liquids:
 IP 20 mounted product
 IP 40 mounted product with support frame and plate
- **6.3 Material characteristics**
 Mechanism casing: PC
 Lens: opalescent white
 Support frame: Galfan steel + Polyamide 6.6 RAL 7016
 Claws: Steel
 Cover plate: ABS
 Colour: White RAL 9003
 Matte white appearance
 painted Black satin finish
 Halogen-free
 UV-resistant

Valena™ Next
2-wire automatic switch 100 VA LED
3-wire automatic switch 500 VA LED

Cat. No(s): 7 415 61A/62A - 7 417 61A/62A - 7 419 61A/62A
 7 415 60A - 7 417 60A - 7 419 69A

6. TECHNICAL CHARACTERISTICS (continued)

■ **6.3 Material characteristics** (continued)













Self-extinguishing:
 850°C/30 s for insulating components holding live parts in place
 650°C/30 s for other insulating components.

■ **6.4 Climate characteristics**

Usage temperature: -5°C to +35°C
 Storage temperature: -10°C to +70°C

■ **6.5 Electrical characteristics - 2-wire without neutral**

Voltage: 110-240 V~
 Current: 0.63 A max.
 Frequency: 50/60 Hz
 Standby consumption: < 0.010 W













			(*) LED 	(*) 	(*) 	(*) (**) 	(*) 
							
240 V~	Max.	150 W	100 VA	100 VA	150 VA	150 VA	150 VA
	Min.	2 W	2 VA	2 VA	2 VA	2 VA	2 VA
110 V~	Max.	75 W	50 VA	50 VA	75 VA	75 VA	75 VA
	Min.	2 W	2 VA	2 VA	2 VA	2 VA	2 VA

(*) If the load malfunctions, it may be necessary to use bleeder Cat. No. 0 401 49.

Important: Take transformer losses into account when calculating the power.

■ **6.6 Electrical characteristics - 3-wire with neutral**

Voltage: 110-240 V~
 Current: 8.5 A MAX
 Frequency: 50/60 Hz
 Standby consumption: < 0.015 W

			LED 			(**) 	
							
240 V~	Max.	2000 W	500 VA	500 VA	1000 VA	1000 VA	1000 VA
110 V~	Max.	1000 W	250 VA	250 VA	500 VA	500 VA	500 VA

Important: Take account of transformer losses when calculating power.

■ **6.7 Energy characteristics**

Standby consumption for 1000 hours:
 2-wire without neutral: 0.088 kWh
 3-wire with neutral: 0.131 kWh

7. CLEANING

Keep the lens clean.
 Surface cleaning with a cloth.

Resistance to the following agents:

Hexane (EN 60669-1), methylated spirits, soapy water, diluted ammonia, pure bleach diluted to 10%, window-cleaning products, pre-impregnated wipes.

Caution: Always test before using other special cleaning product.

8. STANDARDS AND APPROVALS

Compliant with installation and manufacturing standards.
 See e. catalogue.