

Data Sheet | Item Number: 279-682

3-conductor through terminal block; 1.5 mm²; center marking; for DIN-rail 35 x 15 and 35 x 7.5; CAGE CLAMP®; 1,50 mm²; orange

<https://www.wago.com/279-682>

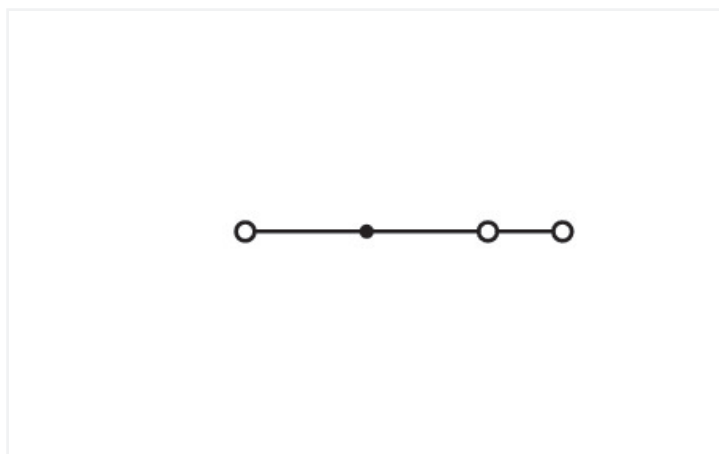
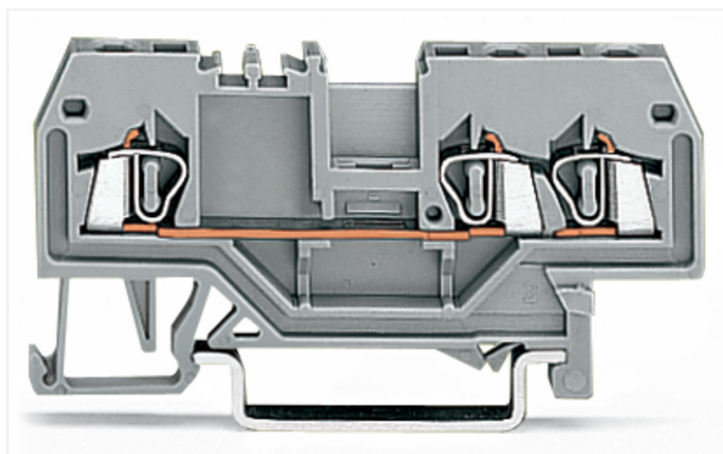

Color: ■ orange

Similar to illustration

Similar to illustration

Through terminal block, 279 Series, orange

Quick and easy connections are guaranteed with this through terminal block (item number 279-682). Conductors can only be connected to this through terminal block if their strip length is between 8 and 9 mm. Whether for use in industry or building installations, our rail-mount through terminal blocks allow you to quickly and securely connect electrical conductors. They're perfect for use in either classic through-wiring or distributing potential, depending on the variant. Featuring conductor terminals along with CAGE CLAMP®, this product delivers reliable performance. Our highly-rated and maintenance-free CAGE CLAMP® connection makes it easy to connect all conductor types without having to prepare the conductor. For example, you don't need to crimp ferrules. The item's dimensions are (4 x 62.5 x 31.5) mm (width x height x depth). This through terminal block is suitable for conductor cross sections ranging from 0.08 mm² to 1.5 mm².

This through rail-mount terminal block is operated with an operating tool.

Electrical data							
Ratings per	IEC/EN 60947-7-1			Approvals per	UL 1059		
Overvoltage category	III	III	II	Use group	B	C	D
Pollution degree	3	2	2	Rated voltage	-	600 V	-
Nominal voltage	800 V	-	-	Rated current	-	10 A	-
Rated impulse withstand voltage	8 kV	-	-				
Rated current	18 A	-	-				
Approvals per	CSA 22.2 No 158			Power Loss			
Use group	B	C	D	Power loss, per pole (potential)	0.5929 W		
Rated voltage	-	600 V	-	Rated current I _N for power loss specification	18 A		
Rated current	-	10 A	-	Resistance value for specified, current-dependent power loss	0.00183 Ω		

General information

Wiring direction	Front-entry wiring
------------------	--------------------

Connection Data

Clamping units	3	Connection 1	
Total number of potentials	1	Connection technology	CAGE CLAMP®
Number of levels	1	Actuation type	Operating tool
		Connectable conductor materials	Copper
		Solid conductor	0.08 ... 1.5 mm ² / 28 ... 16 AWG
		Fine-stranded conductor	0.08 ... 1.5 mm ² / 28 ... 16 AWG
		Strip length	8 ... 9 mm / 0.31 ... 0.35 inches
		Wiring direction	Front-entry wiring

Physical data

Width	4 mm / 0.157 inches
Height	62.5 mm / 2.461 inches
Depth from upper-edge of DIN-rail	27 mm / 1.063 inches
Depth	31.5 mm / 1.24 inches

Mechanical data

Mounting type	DIN-35 rail
Marking level	Center marking

Material data

Note (material data)	Information on material specifications can be found here
Color	orange
Material group	I
Insulation material (main housing)	Polyamide (PA66)
Flammability class per UL94	V0
Fire load	0.101 MJ
Weight	5.4 g

Environmental requirements

Processing temperature	-35 ... +85 °C
Continuous operating temperature	-60 ... +105 °C

Commercial data

PU (SPU)	100 pcs
Packaging type	Box
Country of origin	DE
GTIN	4044918650489
Customs tariff number	85369010000

Product Classification

UNSPSC	39121410
eCl@ss 10.0	27-14-11-20
eCl@ss 9.0	27-14-11-20
ETIM 9.0	EC000897
ETIM 10.0	EC000897
ECCN	NO US CLASSIFICATION

Environmental Product Compliance

RoHS Compliance Status	Compliant, No Exemption
------------------------	-------------------------

Approvals / Certificates

General approvals



Approval	Standard	Certificate Name
CSA DEKRA Certification B.V.	C22.2 No. 158	70133738
KEMA/KEUR DEKRA Certification B.V.	EN 60947	2160584.04
UL Underwriters Laboratories Inc.	UL 1059	E45172

Declarations of conformity and manufacturer's declarations

Approval	Standard	Certificate Name
EU-Declaration of Conformity WAGO GmbH & Co. KG	-	-
UK-Declaration of Conformity WAGO GmbH & Co. KG	-	-

Approvals for marine applications



Approval	Standard	Certificate Name
ABS American Bureau of Shipping	-	24-0152298-PDA
BV Bureau Veritas S.A.	EN 60947	07436/G0 BV
DNV GL Det Norske Veritas, Germanischer Lloyd	-	TAE00001V2
LR Lloyds Register	EN 60947	LR23325966TA
PRS Polski Rejestr Statków	-	TE/1094/880590/23

Downloads

Environmental Product Compliance

Compliance Search			
Environmental Product Compliance 279-682			↓

Documentation

Bid Text			
279-682	19.02.2019	xml 3.19 KB	↓
279-682	28.02.2017	doc 23.50 KB	↓

CAD/CAE-Data

CAD data	
2D/3D Models 279-682	↓

CAE data	
EPLAN Data Portal 279-682	↓
WSCAD Universe 279-682	↓
ZUKEN Portal 279-682	↓

1 Compatible Products

1.1 Required Accessories

1.1.1 End plate

1.1.1.1 End plate



Item No.: 279-308
End and intermediate plate; 2 mm thick; gray



Item No.: 279-339
End and intermediate plate; 2 mm thick; orange



Item No.: 279-309
Separator plate; 2 mm thick; oversized; gray



Item No.: 279-340
Separator plate; 2 mm thick; oversized; orange

1.2 Optional Accessories

1.2.1 DIN-rail

1.2.1.1 Mounting accessories



Item No.: 210-196
Aluminum carrier rail; 35 x 8.2 mm; 1.6 mm thick; 2 m long; unslotted; similar to EN 60715; silver-colored



Item No.: 210-198
Copper carrier rail; 35 x 15 mm; 2.3 mm thick; 2 m long; unslotted; according to EN 60715; copper-colored



Item No.: 210-508
Steel carrier rail; 35 x 15 mm; 1.5 mm thick; 2 m long; slotted; galvanized; similar to EN 60715; silver-colored



Item No.: 210-197
Steel carrier rail; 35 x 15 mm; 1.5 mm thick; 2 m long; slotted; similar to EN 60715; silver-colored



Item No.: 210-506
Steel carrier rail; 35 x 15 mm; 1.5 mm thick; 2 m long; unslotted; galvanized; similar to EN 60715; silver-colored



Item No.: 210-114
Steel carrier rail; 35 x 15 mm; 1.5 mm thick; 2 m long; unslotted; similar to EN 60715; silver-colored



Item No.: 210-118
Steel carrier rail; 35 x 15 mm; 2.3 mm thick; 2 m long; unslotted; according to EN 60715; silver-colored



Item No.: 210-115
Steel carrier rail; 35 x 7.5 mm; 1 mm thick; 2 m long; slotted; according to EN 60715; "Hole width 18 mm; silver-colored

1.2.1.1 Mounting accessories



Item No.: 210-112
Steel carrier rail; 35 x 7.5 mm; 1 mm thick; 2 m long; slotted; according to EN 60715; Hole width 25 mm; silver-colored



Item No.: 210-504
Steel carrier rail; 35 x 7.5 mm; 1 mm thick; 2 m long; slotted; galvanized; according to EN 60715; silver-colored



Item No.: 210-113
Steel carrier rail; 35 x 7.5 mm; 1 mm thick; 2 m long; unslotted; according to EN 60715; silver-colored



Item No.: 210-505
Steel carrier rail; 35 x 7.5 mm; 1 mm thick; 2 m long; unslotted; galvanized; according to EN 60715; silver-colored

1.2.2 End plate

1.2.2.1 End plate



Item No.: 284-334
Step-down cover plate; 1 mm thick; for 2-, 3- and 4-conductor terminal blocks; gray



Item No.: 284-344
Step-down cover plate; 1 mm thick; for 2-, 3- and 4-conductor terminal blocks; orange

1.2.3 Ferrule

1.2.3.1 Ferrule



Item No.: 216-301
Ferrule; Sleeve for 0.25 mm² / AWG 24; insulated; electro-tin plated; yellow



Item No.: 216-302
Ferrule; Sleeve for 0.34 mm² / 22 AWG; insulated; electro-tin plated; light turquoise



Item No.: 216-201
Ferrule; Sleeve for 0.5 mm² / 20 AWG; insulated; electro-tin plated; electrolytic copper; acc. to DIN 46228, Part 4/09.90; white



Item No.: 216-101
Ferrule; Sleeve for 0.5 mm² / AWG 22; un-insulated; electro-tin plated; silver-colored



Item No.: 216-202
Ferrule; Sleeve for 0.75 mm² / 18 AWG; insulated; electro-tin plated; gray



Item No.: 216-102
Ferrule; Sleeve for 0.75 mm² / AWG 20; un-insulated; electro-tin plated; silver-colored



Item No.: 216-203
Ferrule; Sleeve for 1 mm² / AWG 18; un-insulated; electro-tin plated; red



Item No.: 216-103
Ferrule; Sleeve for 1 mm² / AWG 18; un-insulated; electro-tin plated

1.2.4 Installation

1.2.4.1 Cover



Item No.: 709-153
Cover; Type 1; suitable for cover carrier, type 1; 1 m long; transparent

1.2.4.2 Cover carrier



Item No.: 709-167
Cover carrier; Type 1; incl. fixing/retaining screws and knurled nut; suitable for 279 to 282 and 880 Series rail-mounted terminal blocks; suitable for 264 Series miniature rail-mounted terminal blocks; suitable for 270 Series sensor and actuator terminal blocks; gray

1.2.4.3 Mounting accessories



Item No.: 209-106

Mounting carrier; for isolated mounting on DIN 35 rails; gray

Item No.: 249-116

Screwless end stop; 6 mm wide; for DIN-rail 35 x 15 and 35 x 7.5; gray

1.2.5 Insulation stop

1.2.5.1 Insulation stop



Item No.: 279-470

Insulation stop; 0.08 - 0.2 mm² "s" (0.14 mm² "f-st"); 5 pieces/strip; white

Item No.: 279-471

Insulation stop; 0.25 mm²; 5 pieces/strip; dark gray

1.2.6 Jumper

1.2.6.1 Jumper



Item No.: 279-490

Jumper; 10-way; insulated; gray

Item No.: 279-482

Jumper; 2-way; insulated; gray

Item No.: 279-492

Jumper; 2-way; insulated; gray

Item No.: 279-483

Jumper; 3-way; insulated; gray



Item No.: 279-402

Jumper; insulated; gray

Item No.: 279-409

Jumper; insulated; gray

Item No.: 279-422

Jumper; insulated; yellow-green

Item No.: 284-414

Step-down jumper; from 284/282 to 281/280/279 series; insulated; gray

1.2.7 Marking

1.2.7.1 Double marker carrier



Item No.: 209-128

Adaptor; gray

1.2.7.2 Group marker carrier



Item No.: 209-140

Group marker carrier; gray

Item No.: 209-141

Group marker carrier; gray

Item No.: 209-142

Group marker carrier; gray

Item No.: 249-105

Group marker carrier; gray

1.2.7.3 Marker



Item No.: 793-4501/000-006

WMB marking card; as card; stretchable 4 - 4.2 mm; plain; snap-on type; blue

Item No.: 793-4501/000-014

WMB marking card; as card; stretchable 4 - 4.2 mm; plain; snap-on type; brown

Item No.: 793-4501/000-007

WMB marking card; as card; stretchable 4 - 4.2 mm; plain; snap-on type; gray

Item No.: 793-4501/000-023

WMB marking card; as card; stretchable 4 - 4.2 mm; plain; snap-on type; green



Item No.: 793-4501/000-017

WMB marking card; as card; stretchable 4 - 4.2 mm; plain; snap-on type; light green

Item No.: 793-4501/000-012

WMB marking card; as card; stretchable 4 - 4.2 mm; plain; snap-on type; orange

Item No.: 793-4501/000-005

WMB marking card; as card; stretchable 4 - 4.2 mm; plain; snap-on type; red

Item No.: 793-4501/000-024

WMB marking card; as card; stretchable 4 - 4.2 mm; plain; snap-on type; violet

1.2.7.3 Marker



Item No.: 793-4501
WMB marking card; as card; stretchable 4 - 4.2 mm; plain; snap-on type; white

Item No.: 793-4501/000-002
WMB marking card; as card; stretchable 4 - 4.2 mm; plain; snap-on type; yellow

Item No.: 2009-114/000-006
WMB-Inline; for Smart Printer; 2000 pieces on roll; stretchable 4 - 4.2 mm; plain; snap-on type; blue

Item No.: 2009-114/000-007
WMB-Inline; for Smart Printer; 2000 pieces on roll; stretchable 4 - 4.2 mm; plain; snap-on type; gray



Item No.: 2009-114/000-023
WMB-Inline; for Smart Printer; 2000 pieces on roll; stretchable 4 - 4.2 mm; plain; snap-on type; green

Item No.: 2009-114/000-012
WMB-Inline; for Smart Printer; 2000 pieces on roll; stretchable 4 - 4.2 mm; plain; snap-on type; orange

Item No.: 2009-114/000-005
WMB-Inline; for Smart Printer; 2000 pieces on roll; stretchable 4 - 4.2 mm; plain; snap-on type; red

Item No.: 2009-114/000-024
WMB-Inline; for Smart Printer; 2000 pieces on roll; stretchable 4 - 4.2 mm; plain; snap-on type; violet



Item No.: 2009-114
WMB-Inline; for Smart Printer; 2000 pieces on roll; stretchable 4 - 4.2 mm; plain; snap-on type; white

Item No.: 2009-114/000-002
WMB-Inline; for Smart Printer; 2000 pieces on roll; stretchable 4 - 4.2 mm; plain; snap-on type; yellow

1.2.8 Protective warning marker

1.2.8.1 Cover



Item No.: 279-415
Protective warning marker; 5-pole; with high-voltage symbol, black; yellow

1.2.9 Push-in type wire jumper

1.2.9.1 Jumper



Item No.: 249-126
Push-in type wire jumper; 0.75 mm²; insulated; 110 mm long; black

Item No.: 249-123
Push-in type wire jumper; 0.75 mm²; insulated; 180 mm long; black

Item No.: 249-127
Push-in type wire jumper; 0.75 mm²; insulated; 250 mm long; black

Item No.: 249-125
Push-in type wire jumper; insulated; 60 mm long; black

1.2.10 Test and measurement

1.2.10.1 Testing accessories



Item No.: 280-404
Test plug adapter; 5 mm wide; for test plug (2.3 mm Ø); suitable for 1.5 mm² - 4 mm² tbs; gray

Item No.: 209-170
Test plug adapter; 8.3 mm wide; for 4 mm Ø test plugs; suitable for 1.5 mm² - 10 mm² tbs; gray

1.2.11 Tool

1.2.11.1 Operating tool



Item No.: 210-719

Operating tool; Blade: 2.5 x 0.4 mm; with a partially insulated shaft



Item No.: 210-648

Operating tool; Blade: 2.5 x 0.4 mm; with a partially insulated shaft; angled; short



Item No.: 210-647

Operating tool; Blade: 2.5 x 0.4 mm; with a partially insulated shaft; multicoloured

Installation Notes

Installation

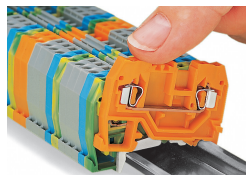

Snapping a terminal block onto the DIN-rail.

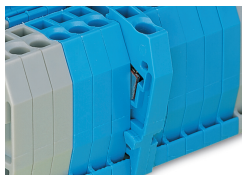

Quick assembly keys prevent reverse mounting.

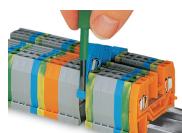

Removing a terminal block from the assembly.



Steel DIN-rails are not suited for PEN (ground and N-conductor) applications per EN 60947-7-2 (VDE 0611, Part 3).

Conductor termination

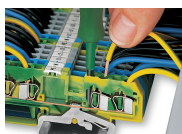

CAGE CLAMP® connection
Inserting a conductor.

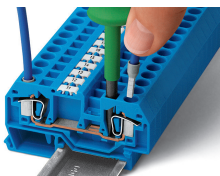

CAGE CLAMP® connection
Inserting a conductor.
With ferruled conductors, it is necessary to use a terminal block one size larger than the conductor's nominal cross-section.



Inserting insulation stops.

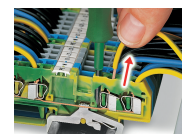

CAGE CLAMP® connection
Removing a solid conductor.

Commoning

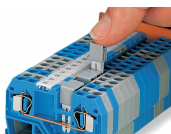

Commoning using an adjacent jumper. Push jumper down until fully inserted!

Push-In Type Wire Jumpers

When installing machines or control systems, it is often necessary to make an additional connection between two terminal blocks that are not next to each other on the rail. In such cases, WAGO's touch-proof, push-in type wire jumpers are the ideal solution.

These jumpers are compatible with the following rail-mount terminal blocks:
 - 279 Series (1.5 mm²/16 AWG),
 - 280/775/780 Series (2.5 mm²/14 AWG)
 - 281/769/776/777/781 and 880 Series (4 mm²/12 AWG)

They are available in three conductor lengths (60, 110 and 250 mm), allowing up to 60 terminal blocks to be commoned depending on their width (see table on the right).

The 280/775/780 and 281/776/777/781 Series Terminal Blocks accept two wire jumpers, allowing the use of commoning chains. Furthermore, the 280/769/775/780/880 and 281/776/777/781 Series allow both wire jumper and adjacent jumper to be simultaneously plugged into a same terminal block.

Commoning using comb-style jumper bars: Push comb-style jumper bars down until fully inserted.

Commoning terminal blocks of different sizes via step-down jumpers.

Testing

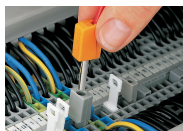

Testing with a test plug. Picture shows a test plug adapter (209-170).

Cover

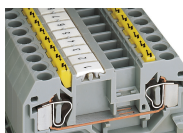

Protective warning markers inserted into the operating slots

Marking



Labeling via WMB Multi Marking System.