

Data Sheet | Item Number: 771-9293/015-603

pre-assembled interconnecting cable; B2ca; Socket/plug; 3-pole; Cod. B; Control cable 3 x 1.0 mm²; 6 m; 1,00 mm²

<https://www.wago.com/771-9293/015-603>

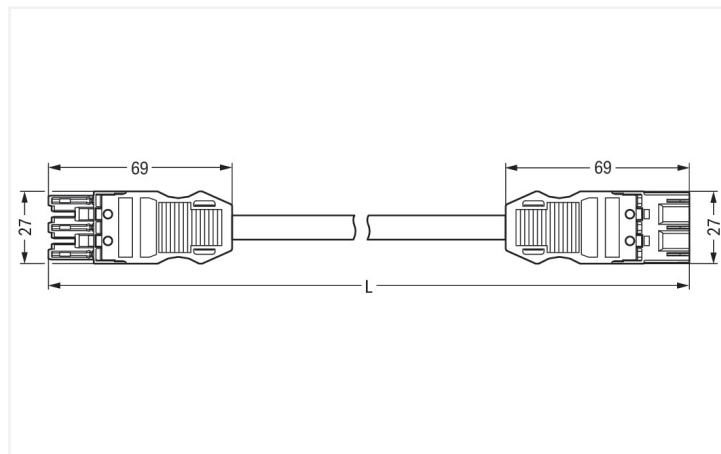

Dimensions in mm

Cable assembly WINSTA® MIDI 3-pole

The WINSTA® MIDI cable assembly with protection against mismatching is the pluggable solution for your use in control cabinets, on PCBs or for lighting connections. The pluggable installation connectors with spring pressure connection technology work entirely without screw connections. They allow flexible, error-free installation in a large number of possible uses. The coding options reduce installation errors, allowing fast, maintenance-free wiring of all components. The pluggable installation connector offers protection against contact with live components in accordance with protection type IP20 (When mated: IP2xC (These compact connectors are not designed for use in open, easily accessible areas!)). Solutions like the WINSTA® MIDI pluggable installation connectors with B coding are appropriate for process control, for example, for lighting or in data networks. The WINSTA® MIDI Pluggable Connection System with Push-in CAGE CLAMP® spring pressure connection technology facilitates exemplary electrification. Due to the built-in test slot, it is possible to check connections even when they are plugged in. This saves time, labor, and money. Anyone who needs to take into account technical safety requirements related to fire protection for electrical installation should be able to rely on the quality of the components. Our product meets the strict safety standards of fire class B2. The cable assembly is free of halogen. This eliminates the addition of environmental pollutants during production. It also increases the fire class, since halogen-free materials do not easily ignite.

Pluggable connections instead of screw connections – cable assemblies from WAGO

A socket and a plug are provided. The WINSTA® Pluggable Connection System allows pluggable electrical installation. This significantly reduces the need for servicing and lowers costs. Now you can also cut installation costs without compromising quality and safety: with marking eliminates the need for servicing and prevents unnecessary downtime.

- pluggable installation connectors with protection against mismatching
- pre-assembled versions
- with B coding for use in process automation, such as lighting technology, for instance
- flexible installation to save space
- fast, secure installation

Notes

Note	Cables with a different fire class can be found in the eShop.
Variants:	Other pole markings Other versions (or variants) can be requested from WAGO Sales or configured at https://configurator.wago.com/ .

Electrical data

Ratings per	IEC/EN 60664-1			General information	
Overvoltage category	III	III	II	Note on contact resistance	approx. 1 mΩ of contact resistance approx. 0.25 mΩ contact transition plug/ socket
Pollution degree	3	2	2		
Nominal voltage	250 V	-	-		
Rated impulse withstand voltage	4 kV	-	-		
Rated current	10 A	-	-		

Connection Data

Total number of potentials	3	Connection 1	
		Pole number	3
		Wire cross-section	1 mm ²
		Connection type	Socket - Plug

Physical data

Pin spacing	10 mm / 0.394 inches
Width	27 mm / 1.063 inches
Total length	6 m

Mechanical data

Use	Control technology
Coding	B
Variable coding	Yes
Marking	1 2 3
Potential marking	1 2 3
Mating force of a plug-in connection	approx. 20 ... 70 N (depending on pole number)
Retention force of a plug-in connection	when locked: > 80N
Unmating force of a plug-in connection	when unlocked: approx. 20 ... 70 N (depending on pole number)
Number of mating cycles	200, without resistive load
Connection type	Socket - Plug
Type of pre-assembled cable	Interconnecting cable
Cable type	H05Z1Z1-F 3x1
Protection type	IP20; When mated: IP2xC (These compact connectors are not designed for use in open, easily accessible areas!)

Plug-in connection

Mismating protection	Yes
Note on mismating protection	All WINSTA® components are 100% protected against mismating when: a.) plugging different numbers of poles b.) plugging while rotated 180 c.) plugging while laterally staggered d.) plugging one pole
Locking lever	Can be retrofitted
Locking of plug-in connection	Locking lever
Note on locking system	All connectors for mounted installations (snap-in versions for lighting fixtures or devices, all types of PCB and distribution connectors) are factory-equipped with locking levers to ensure plugs and sockets are securely locked. Additional locking levers are only required for flying leads (plug/socket).

Material data

Note (material data)	Information on material specifications can be found here
Insulation material (main housing)	Polyamide (PA66)
Flammability class per UL94	V0
Fire class per EN 50575	B2 _{ca}
Contact material	Copper or copper alloy; surface-treated
Contact Plating	Tin
Fire load	0.627 MJ
Connector color	gray
Strain relief color	black
Printing color of strain relief	white
Sheathed cable color	gray
Printing color of sheathed cable	black
Halogen-free	Yes
Silicon-free	Yes
Sheath material	Halogen-free
Rubber cable	No
Weight	446.9 g
Copper weight of the raw cable	0.029 kg/m

Environmental requirements

Processing temperature	-5 ... +40 °C
Continuous operating temperature	-35 ... +85 °C
Note on continuous operating temperature	Cable for temperatures ≤ 70 °C (including halogen-free) Insulating parts for temperatures ≤ 105 °C

Commercial data

PU (SPU)	1 pcs
Packaging type	unpacked
Country of origin	DE
GTIN	4055143758796
Customs tariff number	85444290900

Product Classification	
UNSPSC	26121629
eCl@ss 10.0	27-44-06-04
eCl@ss 9.0	27-44-06-04
ETIM 9.0	EC002587
ETIM 10.0	EC002587
ECCN	NO US CLASSIFICATION

Environmental Product Compliance	
RoHS Compliance Status	Compliant, No Exemption

Downloads

Environmental Product Compliance

Compliance Search	
Environmental Product Compliance 771-9293/015-603	↓





CAD/CAE-Data	
CAE data	
EPLAN Data Portal 771-9293/015-603	↓

1 Compatible Products

1.1 Required Accessories

1.1.1 Locking system





1.1.1.1 Locking system

			
Item No.: 770-101 Locking lever; for flying leads; for manual operation; black	Item No.: 770-121 Locking lever; for flying leads; for manual operation; white	Item No.: 770-111 Locking lever; for flying leads; for tool operation; black	Item No.: 770-131 Locking lever; for flying leads; for tool operation; white

1.2 Optional Accessories

1.2.1 Cover

1.2.1.1 Cover

			
Item No.: 770-201 Lockout cap; 12-pole, separable; for sockets; Plastic; black	Item No.: 770-221 Lockout cap; 12-pole, separable; for sockets; Plastic; white	Item No.: 770-360 Lockout cap; for plugs; 5-pole; separable; yellow	Item No.: 897-2003 Protective cap; Type2; for sockets and plugs; PVC; red

1.2.2 Installation

1.2.2.1 Mounting accessories



Item No.: 770-310

Mounting carrier; 2- to 5-pole; for flying leads; black

1.2.3 Marking

1.2.3.1 Marker



Item No.: 770-450/000-006

Marker card; Plastic; blue



Item No.: 770-450/000-001

Marker card; Plastic; green



Item No.: 770-450/000-012

Marker card; Plastic; orange



Item No.: 770-450/000-005

Marker card; Plastic; red



Item No.: 770-450

Marker card; Plastic; white



Item No.: 770-450/000-002

Marker card; Plastic; yellow

1.2.3.2 Marking strip



Item No.: 210-334

Marking strips; as a DIN A4 sheet; Strip width 5 mm; Strip length 182 mm; plain; Self-adhesive; white