

**Data Sheet | Item Number: 750-454/025-000**  
 2-channel analog input; 4 ... 20 mA; Differential input; Ext. Temperature

<https://www.wago.com/750-454/025-000>

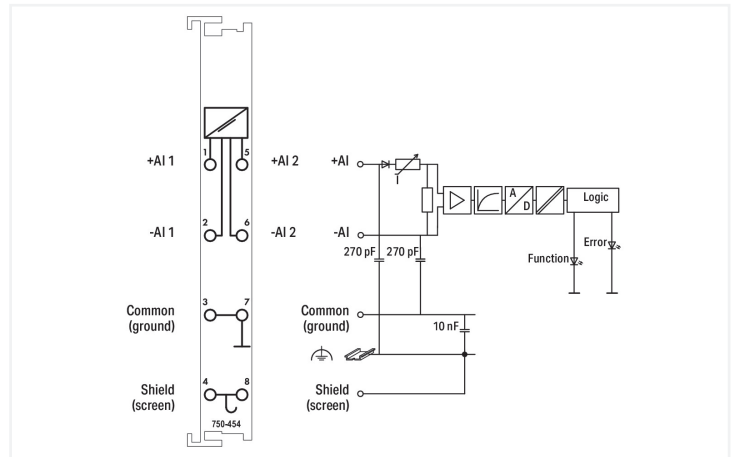

Color: ■ light gray

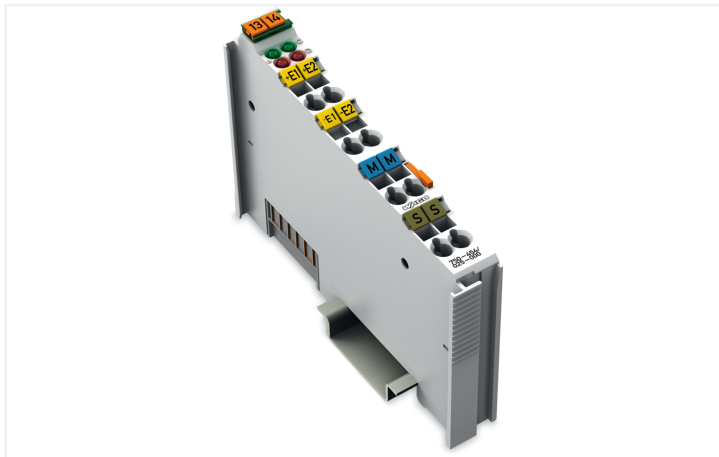
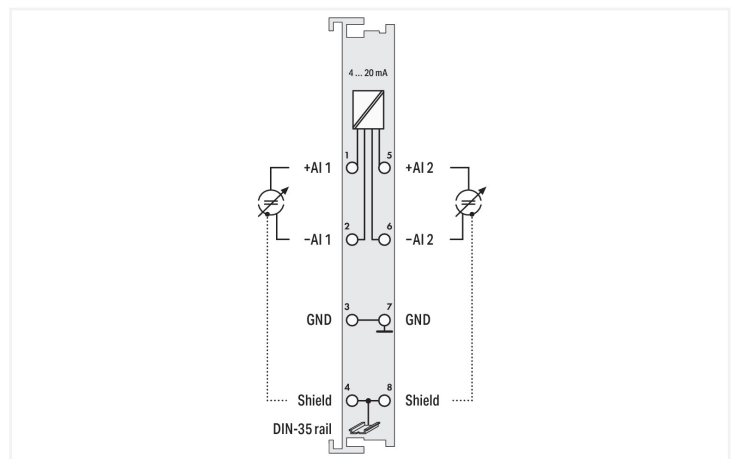
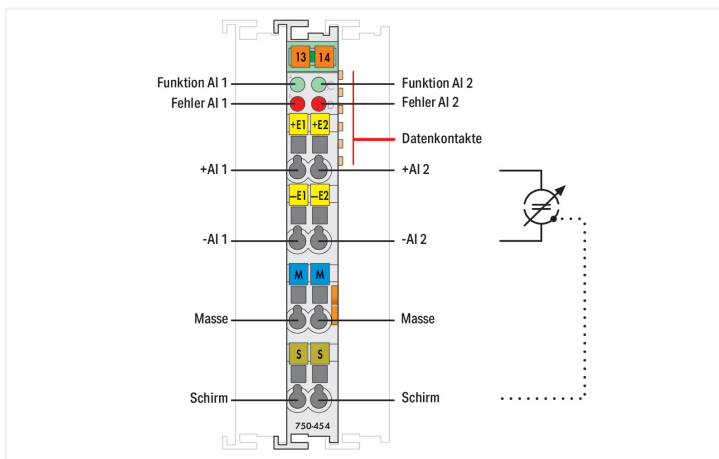

This analog input module processes standard 4–20 mA signals.  
 The input signal is electrically isolated and is transmitted with a resolution of 12 bits.  
 The internal system supply powers the module.  
 The input channels of the module are differential inputs.  
 The shield directly connects to the DIN-rail.

**Technical data**

Number of analog inputs	2
Total number of channels (module)	2
Signal type	Current
Signal type (current)	4 ... 20 mADC
Sensor connection	2 x (2-wire)
Input voltage (max.)	35 V
Signal characteristics	Differential
Resolution [bit]	12 bits
Input resistance (max.)	220 Ω
Data width	2 x 16-bit data; 2 x 8-bit control/status (optional)
Conversion time (typ.)	2 ms
Measurement error (reference temperature)	25 °C
Measurement error, deviation (max.) from the upper-range value	0.2 %

### Technical data

Temperature error (max.) of the upper-range value	0.01 %/K
Supply voltage (system)	5 VDC; via data contacts
Current consumption (5 V system supply)	70 mA
Isolation	500 V system/field
Indicators	LED (A, C) green: Function AI 1, AI 2; LED (B, D) red: Error AI 1, AI 2

### Connection Data

Connection technology: I/O	8 x CAGE CLAMP®
Connectable conductor materials	Copper
Connection type	Inputs/outputs
Solid conductor	0.08 ... 2.5 mm <sup>2</sup> / 28 ... 14 AWG
Fine-stranded conductor	0.08 ... 2.5 mm <sup>2</sup> / 28 ... 14 AWG
Strip length	8 ... 9 mm / 0.31 ... 0.35 inches

### Physical data

Width	12 mm / 0.472 inches
Height	100 mm / 3.937 inches
Depth	69.8 mm / 2.748 inches
Depth from upper-edge of DIN-rail	62.6 mm / 2.465 inches

### Mechanical data

Mounting type	DIN-35 rail
Pluggable connector	fixed

### Material data

Color	light gray
Housing material	Polycarbonate; polyamide 6.6
Fire load	0.693 MJ
Weight	49.9 g
Conformity marking	CE

### Environmental requirements

Ambient temperature (operation)	-20 ... +60 °C
Ambient temperature (storage)	-40 ... +85 °C
Protection type	IP20
Pollution degree	2 per IEC 61131-2
Operating altitude	0 ... 2000 m / 0 ... 6562 ft
Mounting position	Horizontal left, horizontal right, horizontal top, horizontal bottom, vertical top and vertical bottom
Relative humidity (without condensation)	95 %
Relative humidity (with condensation)	Short-term condensation per Class 3K6/IEC EN 60721-3-3 and E-DIN 40046-721-3, accounting for a temperature range of -20 to +60 °C (except for wind-driven precipitation, water and ice formation)
Vibration resistance	4g per IEC 60068-2-6
Shock resistance	15g per IEC 60068-2-27
EMC immunity to interference	per EN 61000-6-2, marine applications
EMC emission of interference	per EN 61000-6-4, marine applications
Exposure to pollutants	per IEC 60068-2-42 and IEC 60068-2-43
Permissible H <sub>2</sub> S contaminant concentration at a relative humidity 75 %	10 ppm
Permissible SO <sub>2</sub> contaminant concentration at a relative humidity 75 %	25 ppm

### Commercial data

Product Group	15 (I/O System)
PU (SPU)	1 pcs
Packaging type	Box
Country of origin	DE
GTIN	4045454643379
Customs tariff number	85389099990

### Product Classification

UNSPSC	32101505
eCl@ss 10.0	27-24-26-01
eCl@ss 9.0	27-24-26-01
ETIM 9.0	EC001596
ETIM 10.0	EC001596
ECCN	NO US CLASSIFICATION

### Environmental Product Compliance

CAS-No.	1303-86-2 1317-36-8 25550-51-0 7439-92-1
REACH Candidate List Substance	4-Methyl-1,2-cyclohexanedicarboxylic anhydride Diboron trioxide Lead Lead monoxide
RoHS Compliance Status	Compliant,With Exemption
RoHS Exemption	7(c)-I
SCIP notification number (Austria)	3b061cc0-7575-4d24-9d35-6b4b676c336e
SCIP notification number (Belgium)	9defc160-144c-4195-965a-85dcfc4d970d
SCIP notification number (Bulgaria)	8e3fdc08-2cc7-42bf-a73e-1c3d851285ae
SCIP notification number (Czech Republic)	36bbe4a1-1983-47f2-81e5-c1b6015f8c0f
SCIP notification number (Denmark)	87d60650-4be4-4f41-9c7a-0e1b1a60b0b7
SCIP notification number (Finland)	5f151ffe-d578-4395-8ecb-9803885c6291
SCIP notification number (France)	5451a99d-edf3-4943-b9a8-e2654792c5cf
SCIP notification number (Germany)	20226263-4466-4334-ac97-3874187593c1
SCIP notification number (Hungary)	fb45438d-5b09-4e0d-9240-11af8e518b29
SCIP notification number (Italy)	9344cefb-da21-49a4-bfb1-a83b603233cb
SCIP notification number (Netherlands)	2f892395-538b-4b6c-88be-e82e7b2ca65d
SCIP notification number (Poland)	45440131-102f-4157-90ee-04b3a50852b2
SCIP notification number (Romania)	89f0206d-f68b-44eb-8177-9ee023bfe330
SCIP notification number (Sweden)	727bbcb5-fb2a-490a-b5d2-61d25db94233

### Approvals / Certificates

#### General approvals



Approval	Standard	Certificate Name
EAC GZO Almaty Standart	TP TC 020/2011	EAC CoC 03083
KC National Radio Research Agency	Article 58-2, Clause 3	MSIP-REM-W43-AIM750
UL Underwriters Laboratories Inc. (ORDINARY LOCATIONS)	UL 508	E175199

#### Declarations of conformity and manufacturer's declarations

Approval	Standard	Certificate Name
EU-Declaration of Conformity WAGO GmbH & Co. KG	-	-
UK-Declaration of Conformity WAGO GmbH & Co. KG	-	-

Approvals for marine applications



Approval	Standard	Certificate Name
ABS American Bureau of Ship- ping	-	22-2227356-PDA
BSH Bundesamt fuer See- schifffahrt und Hydrogra- phie	-	1104
DNV DNV Germany GmbH	DNV-CG-0339,Aug.2021	TAA00001J4
LR Lloyds Register	-	LR2475997TA
PRS Polski Rejestr Statków	-	TE/1102/880590/23

Approvals for hazardous areas



Approval	Standard	Certificate Name
ATEX TUEV Nord Cert GmbH	EN 60079-0	TUEV14ATEX148929X (II 3 G Ex ec IIC T4 Gc)
CCCEX CQST/CNEx	CNCA-C23-01	2020312310000213 (Ex ec IIC T4 Gc)
IECEX TUEV Nord Cert GmbH	IEC 60079-0	IECEX TUN 14.0035 X (Ex ec IIC T4 Gc)
INMETRO TÜV Rheinland do Brasil Ltda.	IEC 60079-0	TÜV 12.1297 X
UKEx WAGO GmbH & Co. KG	EN 60079-0	UKCA_WA GO22UKEX003X_ec
UL Underwriters Laboratories Inc. (HAZARDOUS LOCA- TIONS)	UL 121201	E198726

Downloads

Environmental Product Compliance

Compliance Search

Environmental Product Compliance 750-454/025-000	<a href="#">↓</a>
--	-------------------

Documentation

Manual

System Manual Series 750/753			<a href="#">↓</a>
Product Manual 2- channel, 4-20mA, diff.	V 1.2.0	pdf 2029.37 KB	<a href="#">↓</a>

System Description

750/753 Series I/O- System – General Pro- duct Information		pdf 953.35 KB	<a href="#">↓</a>
Overview on WAGO-I/ O-SYSTEM 750 appro- vals		pdf 770.48 KB	<a href="#">↓</a>

Bid Text

750-454/025-000	19.02.2019	xml 4.35 KB	<a href="#">↓</a>
750-454/025-000	17.10.2017	doc 28.00 KB	<a href="#">↓</a>
750-454/025-000	17.10.2017	docx 16.94 KB	<a href="#">↓</a>

Instruction Leaflet

CCC Ex (Additional in- formation)	26.04.2023	pdf 159.76 KB	<a href="#">↓</a>
--------------------------------------	------------	------------------	-------------------

## CAD/CAE-Data

CAD data	CAE data
2D/3D Models 750-454/025-000	EPLAN Data Portal 750-454/025-000
	WSCAD Universe 750-454/025-000
	ZUKEN Portal 750-454/025-000

## Device Files

Device Driver			
WAGO USB Service Kabel Treiber / Serie 750 und 857	6.5.3.0 10.09.2014	zip 4721.96 KB	

## 1 Compatible Products

### 1.1 Optional Accessories

#### 1.1.1 DIN-rail

##### 1.1.1.1 Mounting accessories



**Item No.: 210-196**  
 Aluminum carrier rail; 35 x 8.2 mm; 1.6 mm thick; 2 m long; unslotted; similar to EN 60715; silver-colored



**Item No.: 210-198**  
 Copper carrier rail; 35 x 15 mm; 2.3 mm thick; 2 m long; unslotted; according to EN 60715; copper-colored



**Item No.: 210-197**  
 Steel carrier rail; 35 x 15 mm; 1.5 mm thick; 2 m long; slotted; similar to EN 60715; silver-colored



**Item No.: 210-114**  
 Steel carrier rail; 35 x 15 mm; 1.5 mm thick; 2 m long; unslotted; similar to EN 60715; silver-colored



**Item No.: 210-118**  
 Steel carrier rail; 35 x 15 mm; 2.3 mm thick; 2 m long; unslotted; according to EN 60715; silver-colored



**Item No.: 210-112**  
 Steel carrier rail; 35 x 7.5 mm; 1 mm thick; 2 m long; slotted; according to EN 60715; "Hole width 25 mm; silver-colored



**Item No.: 210-113**  
 Steel carrier rail; 35 x 7.5 mm; 1 mm thick; 2 m long; unslotted; according to EN 60715; silver-colored

### 1.1.2 Marking

#### 1.1.2.1 Group marker carrier



**Item No.: 750-106**  
 Group marker carrier

#### 1.1.2.2 Marker



**Item No.: 750-100**  
 Marker card; as a DIN A4 sheet; plain



**Item No.: 2009-145/000-006**  
 Mini-WSB Inline; for Smart Printer; 1700 pieces on roll; stretchable 5 - 5.2 mm; plain; snap-on type; blue



**Item No.: 2009-145/000-007**  
 Mini-WSB Inline; for Smart Printer; 1700 pieces on roll; stretchable 5 - 5.2 mm; plain; snap-on type; gray



**Item No.: 2009-145/000-023**  
 Mini-WSB Inline; for Smart Printer; 1700 pieces on roll; stretchable 5 - 5.2 mm; plain; snap-on type; green



**Item No.: 2009-145/000-012**  
 Mini-WSB Inline; for Smart Printer; 1700 pieces on roll; stretchable 5 - 5.2 mm; plain; snap-on type; orange



**Item No.: 2009-145/000-005**  
 Mini-WSB Inline; for Smart Printer; 1700 pieces on roll; stretchable 5 - 5.2 mm; plain; snap-on type; red













**Item No.: 2009-145/000-024**  
 Mini-WSB Inline; for Smart Printer; 1700 pieces on roll; stretchable 5 - 5.2 mm; plain; snap-on type; violet



**Item No.: 2009-145**  
 Mini-WSB Inline; for Smart Printer; 1700 pieces on roll; stretchable 5 - 5.2 mm; plain; snap-on type; white

1.1.2.2 Marker

 <p><b>Item No.: 2009-145/000-002</b> Mini-WSB Inline; for Smart Printer; 1700 pieces on roll; stretchable 5 - 5.2 mm; plain; snap-on type; yellow</p>	 <p><b>Item No.: 248-501/000-006</b> Mini-WSB marking card; as card; not stretchable; plain; snap-on type; blue</p>	 <p><b>Item No.: 248-501/000-007</b> Mini-WSB marking card; as card; not stretchable; plain; snap-on type; gray</p>	 <p><b>Item No.: 248-501/000-023</b> Mini-WSB marking card; as card; not stretchable; plain; snap-on type; green</p>
 <p><b>Item No.: 248-501/000-017</b> Mini-WSB marking card; as card; not stretchable; plain; snap-on type; light green</p>	 <p><b>Item No.: 248-501/000-012</b> Mini-WSB marking card; as card; not stretchable; plain; snap-on type; orange</p>	 <p><b>Item No.: 248-501/000-005</b> Mini-WSB marking card; as card; not stretchable; plain; snap-on type; red</p>	 <p><b>Item No.: 248-501/000-024</b> Mini-WSB marking card; as card; not stretchable; plain; snap-on type; violet</p>
 <p><b>Item No.: 248-501</b> Mini-WSB marking card; as card; not stretchable; plain; snap-on type; white</p>	 <p><b>Item No.: 248-501/000-002</b> Mini-WSB marking card; as card; not stretchable; plain; snap-on type; yellow</p>		

1.1.2.3 Marker carrier

 <p><b>Item No.: 750-103</b> Group marker carrier</p>
--













1.1.3 Shield termination

1.1.3.1 Shield clamping saddles

 <p><b>Item No.: 790-108</b> Shield clamping saddle; 11 mm wide; diameter of compatible conductor; 3 ... 8 mm</p>	 <p><b>Item No.: 790-208</b> Shield clamping saddle; 12.4 mm wide; 3 ... 8 mm</p>	 <p><b>Item No.: 790-116</b> Shield clamping saddle; 19 mm wide; diameter of compatible conductor; 7 ... 16 mm</p>	 <p><b>Item No.: 790-216</b> Shield clamping saddle; 21.8 mm wide; 6 ... 16 mm</p>
 <p><b>Item No.: 790-124</b> Shield clamping saddle; 27 mm wide; diameter of compatible conductor; 6 ... 24 mm</p>	 <p><b>Item No.: 790-220</b> Shield clamping saddle; 30 mm wide; 6 ... 20 mm</p>	 <p><b>Item No.: 790-140</b> Shield clamping saddle; diameter of compatible conductor</p>	

1.1.4 System enclosure

1.1.4.1 System enclosure

 <p><b>Item No.: 850-825</b> IP65 enclosure; Aluminium (RAL 7032); WxHxD (160x100x160 mm); 9 x M12, 4 x M20</p>	 <p><b>Item No.: 850-826</b> IP65 enclosure; Aluminium (RAL 7032); WxHxD (240x100x160 mm); 4 x M20, 4 x M16, 14 x M12 cable grip</p>	 <p><b>Item No.: 850-827</b> IP65 enclosure; Aluminium (RAL 7032); WxHxD (320x100x160 mm); 4 x M20, 8 x M16, 17 x M12 cable grip</p>	 <p><b>Item No.: 850-828</b> IP65 enclosure; Aluminium (RAL 7032); WxHxD (480x100x160 mm); 4 x M20, 10 x M16, 35 x M12 cable grip</p>
 <p><b>Item No.: 850-826/002-000</b> IP65 enclosure; Aluminium (RAL 7035); WxHxD (240x100x160 mm); 4 x M20, 4 x M16, 14 x M12 cable grip</p>	 <p><b>Item No.: 850-827/002-000</b> IP65 enclosure; Aluminium (RAL 7035); WxHxD (320x100x160 mm); 4 x M20, 8 x M16, 17 x M12 cable grip</p>	 <p><b>Item No.: 850-828/002-000</b> IP65 enclosure; Aluminium (RAL 7035); WxHxD (480x100x160 mm); 4 x M20, 10 x M16, 35 x M12 cable grip</p>	 <p><b>Item No.: 850-834</b> IP65 enclosure; Polyester (RAL 7032); WxHxD (164x100x164 mm); 9 x M12, 4 x M20</p>
 <p><b>Item No.: 850-835</b> IP65 enclosure; Polyester (RAL 7032); WxHxD (244x100x164 mm); 4 x M20, 4 x M16, 14 x M12 cable grip</p>	 <p><b>Item No.: 850-836</b> IP65 enclosure; Polyester (RAL 7032); WxHxD (324x100x164 mm); 4 x M20, 8 x M16, 17 x M12 cable grip</p>	 <p><b>Item No.: 850-814/002-000</b> IP65 enclosure; Sheet steel (RAL 7035); WxHxD (200x120x200 mm); without flange plate</p>	 <p><b>Item No.: 850-815/002-000</b> IP65 enclosure; Sheet steel (RAL 7035); WxHxD (300x120x200 mm); without flange plate</p>

### 1.1.4.1 System enclosure



**Item No.: [850-816/002-000](#)**

IP65 enclosure; Sheet steel (RAL 7035);  
WxHxD (400x120x200 mm); without flange plate

**Item No.: [850-817/002-000](#)**

IP65 enclosure; Sheet steel (RAL 7035);  
WxHxD (600x120x200 mm); without flange plate